

BID DOCUMENTS & SPECIFICATIONS FOR:

Construction of Stand-By Emergency Generator Installation for
Wheeler, AASF #1, State of Hawaii, Department of Defense,
Hawai'i Army National Guard, Job No. CA-202004-C1

ISSUED BY:
STATE OF HAWAII
DEPARTMENT OF DEFENSE
3949 DIAMOND HEAD ROAD
HONOLULU, HAWAI'I 96816-4495
TELEPHONE: 808.369.3567

July 2023

TABLE OF CONTENTS

1.	Cover Sheet	
2.	Table of Contents	
3.	Notice to Bidders	
4.	Construction Offer Form	OF-1 to OF-8
5.	Form 1	
6.	Corporate Resolution	
7.	Special Notice to Bidders	SN-1 to SN-10
8.	Special Provisions	SP-1 to SP-7
9.	Certification of Compliance for Employment of State Residents	
10.	Surety Bid Bond	
11.	General Conditions Table of Contents	i to iii
12.	General Conditions	1 to 52
13.	Additional General Conditions	AGC-1 to AGC-3
14.	Request for Substitution	
15.	Weekly Quality Control Report Form Sample	
16.	Scope of Work	
17.	Requirements and Specifications	1 to 314
18.	Maps (Wheeler, AASF #1)	1 to 17
19.	Attachments: HIARNG Environmental Contractor Requirements	

STATE OF HAWAII
DEPARTMENT OF DEFENSE
OFFICE OF THE ADJUTANT GENERAL
3949 DIAMOND HEAD ROAD
HONOLULU, HAWAII 96816-4495

NOTICE TO BIDDERS

SEALED BIDS for furnishing labor, materials, tools and equipment for "**Construction for Stand-By Emergency Generator for Wheeler, AASF #1, State of Hawaii, Department of Defense, Hawaii Army National Guard, Job No. CA-202004-C1**" will be received in the Engineering Office, State of Hawaii, Department of Defense, located in Building 306-A, Room 228, 3949 Diamond Head Road, Honolulu, Hawaii, up to **2:00 PM, Wednesday, August 23, 2023** and will then and there be publicly opened and read aloud. Bids may also be mailed to State of Hawaii, Department of Defense, 3949 Diamond Head Road, Honolulu, HI, 96816-4495, **ATTN: HIENG, Room 228**. Bids must be received in the Engineering Office, Room 228, prior to the time and date fixed for opening to be considered. All bids received in the Engineering Office after the time and date fixed for opening will not be considered.

Bidders are advised that the Department of Defense facility at 3949 Diamond Head Road is a secure facility. To access the property, bidders and/or their authorized personnel shall present a current driver's license or other form of official identification (with photograph) to the security personnel at the entry gate and shall inform the security personnel of the building and room number they require access to (State Contracting Section 369-3567). Lack of official identification or knowledge of the building and room to which access is needed are grounds for denial of access onto the property. Bidders should be aware and allow for security screening and random vehicle inspections. The state will not be responsible for late bids due to the afore mentioned reasons.

Proposed work consists of, but not limited to the following: removal and relocation of an existing portable generator and installation of a new stand-by emergency generator and all required components.

The estimated cost is between \$530,000.00 and \$620,000.00.

A pre-bid/site visit will be held on **Monday, August 7, 2023, at 10:00 AM**. All visitors must have a valid military ID or visitor pass to access Wheeler Air Force Base, AASF #1 (B829) located at 1935 Santos Dumont, Schofield Barracks, Wahiawa, Hawaii, 96857. Interested attendees must apply at Schofield-Lyman (Vehicle Processing Center & Visitor Control Center) before gaining access. Instructions and the visitor pass application can be located at the following link: <https://home.army.mil/hawaii/index.php/about/visitor-information>. Contractors are to meet Project Manager (PM) K Y M at the Schofield Lyman visitors gate by 9:45 AM. Any questions or concern regarding site visit, please contact K Y M at (808) 294-9680 between 9:30 AM and 4:30 PM before Friday, August 4, 2023. All interested bidders and subcontractors are welcome.

Bona fide bidders may obtain copies of applicable specifications and bidding documents at the above-named office. Documents may also be downloaded from the State Procurement Office website at <http://spo.hawaii.gov/> and at the State Department of Defense website at <http://dod.hawaii.gov/hieng/>. If prospective bidders obtain copies of the bid documents from sources other than the Contracting and Engineering Office address listed above, then bidders are responsible to register by sending their company name, address, telephone and facsimile number, and email address via email to ernett.m.kitzmiller-maihui@hawaii.gov.

If you need an auxiliary aid/service or other accommodation due to a disability, contact Ernett Kitzmiller-Maihui at 808-369-3487 or by e-mail at ernett.m.kitzmiller-maihui@hawaii.gov as soon as possible, preferably by August 4, 2023. If a response is received after August 4, 2023, we will try to

obtain the auxiliary aid/service or accommodation, but we cannot guarantee that the request will be fulfilled. Upon request, this notice is available in alternate formats such as large print, Braille, or electronic copy.

All requests for substitution, clarification of bidding documents and/or specifications must be received in the office listed above, via email, prior to **August 10, 2023 on or before 4:30 PM.** Questions shall be emailed to ernett.m.kitzmiller-maihui@hawaii.gov.

Late submittals for this solicitation will not be reviewed by this agency.

An Intent to Bid is NOT required to be submitted for this project.

Bidders are required to register on the Hawaii Compliance Express web site for all tax clearances by going to <http://spo.hawaii.gov/> click on "HCE" and register there.

Bidders are responsible for checking for any addenda for this project. The addenda will be posted on the State Procurement Office web site under the project name at <http://spo.hawaii.gov/>.

The Hawaii Products preference pursuant to ACT 175, SLH 2009 may be applicable for numerous items throughout this solicitation. Persons wishing to certify and qualify a product not currently listed as a Hawaii Product shall submit a Certification for Hawaii Product Preference (form SPO-38) by e-mail to ernett.m.kitzmiller-maihui@hawaii.gov prior to 4:30 PM, fifteen (15) days prior to the bid opening date for this project. View the current Hawaii Products List on the State Procurement office (SPO) website at <http://hawaii.gov/spo>.

For each product, one form shall be completed and submitted (i.e. 3 products should have 3 separate forms completed). The form is available on the SPO webpage at <http://hawaii.gov/spo>.

CAMPAIGN CONTRIBUTIONS BY STATE AND COUNTY CONTRACTORS PROHIBITED.

If awarded a contract in response to this solicitation, offeror agrees to comply with HRS §11-355, which states that campaign contributions are prohibited from a State and County government contractor during the term of the contract if the contractor is paid with funds appropriated by the legislative body between the execution of the contract through the completion of the contract.

REQUIREMENT FOR CONTRACTORS LICENSING CLASSIFICATIONS

Due to the nature of the work contemplated bidder must possess a valid State of Hawaii Contractor's license in the appropriate classification: 'B' General Contractor.

Bidders are solely responsible to review the project requirements, determine the appropriate specialty classification: 'C' Specialty Contractor licenses required. Bidders are responsible to ensure that they possess and that the Subcontractor(s) listed in their OFFER FORM possess the necessary specialty licenses to perform the work for this project.

General Engineering Contractors holding an 'A' license and General Building Contractors holding a 'B' license are reminded that due to the Hawaii Supreme Court's January 28, 2002, decision in Okada Trucking Co., Ltd. v. Board of Water Supply, et al., 97 Haw. 450 (2002), they are prohibited from undertaking any work, solely or as part of a larger project, which would require the General Contractor to act as a specialty Contractor in any area in which the General Contractor has no license.

Kenneth S. Hara
Major General
Adjutant General

Posted on: July 27, 2023

**CONSTRUCTION OF STAND-BY EMERGENCY GENERATORS FOR WHEELER, AASF #1,
STATE OF HAWAII, DEPARTMENT OF DEFENSE, HAWAII ARMY NATIONAL GUARD,
JOB NO. CA-202004-C1**

Adjutant General
State Department of Defense
3949 Diamond Head Road
Honolulu, Hawaii, 96816-4495

Dear Sir:

The undersigned has carefully read and understands the terms and conditions specified in the Specifications, and all documents attached hereto, and hereby submits the following offer to perform the work specified herein, all in accordance with the true intent and meaning thereof. The undersigned further understands and agrees that by submitting this offer, 1) he/she is declaring his/her offer is not in violation of Chapter 84, Hawaii Revised Statutes, concerning prohibited State contracts, and 2) he/she is certifying that the price(s) submitted was (were) independently arrived at without collusion.

The undersigned represents: **(Check one only)**

- A **Hawaii business** incorporated or organized under the laws of the State of Hawaii; **OR**
 A **Compliant Non-Hawaii business** not incorporated or organized under the laws of the State of Hawaii. Business shall be registered prior to award at the State of Hawaii Department of Commerce and Consumer Affairs Business Registration Division to do business in the State of Hawaii. State of incorporation: _____

Offeror is:

- Sole Proprietor Partnership Corporation Joint Venture
 Other _____

Federal I.D. No.: _____

Hawaii General Excise Tax License I.D. No.: _____

Payment address (other than street address below): _____
City, State, Zip Code: _____

Business address (street address): _____
City, State, Zip Code: _____

Respectfully submitted:

(x) _____
Authorized (Original) Signature (*1)

Date: _____

Telephone No.: _____
Name and Title (Please Type or Print)

* _____
Exact Legal Name of Company (Offeror) (*2)

Fax No.: _____

E-mail Address: _____

(*1) Original signature in ink. If unsigned or the affixed signature is a facsimile or a photocopy, the offer shall be automatically rejected unless accompanied by other material, containing an original signature, indicating the Offeror's intent to be bound.

(*2) If Offeror is a "dba" or a "division" of a corporation, furnish the exact legal name of the corporation under which the awarded contract will be executed:

The undersigned has carefully examined the attached plans and specifications and hereby proposes to furnish at his own expense all labor, materials, tools, and equipment necessary to construct all work as shown and called for, in strict accordance with the specifications, schedules and drawings pertaining thereto, all for the LUMP SUM of:

_____ DOLLARS (\$_____).

[BIDDER'S INSTRUCTIONS: Fill in the total lump sum bid price in numbers and write out the total lump sum bid price in words. Prices shall be written in ink or typed.]

(Including the cost of delivery, unloading, freight charges, all applicable taxes, and other cost involved) and will fully complete all the work under this contract within 333 consecutive calendar days from the date of commencement specified by the written order of the Adjutant General including the date of said order.

NOTE:

1. This project falls under the requirement of the "Buy American Act".
2. Davis-Bacon Act prevailing wage rate or State wage rates apply to this contract.
3. Contract will be awarded based on the total lump sum bid.
4. A pre-bid/site visit will be held **Monday, August 7, 2023, at 10:00 AM** All visitors must have a valid military ID or visitor pass to access Wheeler Air Force Base, AASF #1 (B829) located at 1935 Santos Dumont, Scofield Barracks, Wahiawa, Hawaii, 96857. Interested attendees must apply at Schofield-Lyman (Vehicle Processing Center & Visitor Control Center) before gaining access. Instructions and the visitor pass application can be located at the following link: <https://home.army.mil/hawaii/index.php/about/visitor-information>. Contractors are to meet Project Manager (PM) K Y M at the Schofield Lyman visitors gate by 9:45 AM. Any questions or concern regarding site visit, please contact K Y M at (808) 294-9680 between 9:30 AM and 4:30 PM before Friday, August 4, 2023. All interested bidders and subcontractors are welcome.

All requests for substitution, clarification of bidding documents and/or specifications must be received by email at ernett.m.kitzmiller-maihui@hawaii.gov prior to **August 10, 2023 on or before 4:30 PM.**

5. The State reserves the right to determine the extent of the contract by selecting and/or omitting bid items (not necessarily in sequence) to the extent required to come within the funds available for the project. The award of the contract shall be made to the responsible bidder whose total bid is the lowest.
6. **CAMPAIGN CONTRIBUTIONS BY STATE AND COUNTY CONTRACTORS PROHIBITED.** If awarded a contract in response to this solicitation, offeror agrees to comply with HRS §11-355, which states that campaign contributions are prohibited from a State and County government contractor during the term of the contract if the contractor is paid with funds appropriated by the legislative body between the execution of the contract through the completion of the contract.

7. The Surety shall not be held liable beyond two (2) years of the project acceptance date.

HAWAII PRODUCTS PREFERENCE

In accordance with ACT 175, SLH 2009 the Hawaii Products preference is applicable to this solicitation. Hawaii products may be available for those items noted on the offer form. The Hawaii Products List is available on the State Procurement Office (SPO) website at <http://spo.hawaii.gov/> search for "Hawaii Product Preferences".

Offeror offering a Hawaii Product (HP) shall identify the HP on the solicitation offer pages. Any person desiring a Hawaii product preference shall have the product(s) certified and qualified if not currently on the Hawaii Products list, prior to the deadline for receipt of offer(s) specified in the procurement notice and solicitation. The responsibility for certification and qualification shall rest upon the person requesting the preference.

Persons desiring to qualify their product(s) not currently on the Hawaii Product list shall complete form SPO-38, *Certification for Hawaii Product Preference*, and submit to the Department of Defense, Contracting Officer, and provide all additional information required by the Contracting Officer no later than 4:30 PM, fifteen (15) calendar days prior to the bid opening date. For each product, one form shall be completed and submitted (i.e. 3 products should have 3 separate forms completed). The form is available on the SPO webpage at <http://spo.hawaii.gov/> search for "Forms" and select form SPO-38.

Late submittals for this project will not be reviewed by the Department.

Change in Availability of Hawaii Product

In the event of any change that materially alters the offeror's ability to supply Hawaii Products, the offeror shall immediately notify the Contracting Officer in writing and the parties shall enter into discussions for the purposes of revising the contract or terminating the contract for convenience.

Offerors shall indicate in the Hawaii Product Schedule below whether the pre-approved Hawaii Products are offered. Offerors offering a Hawaii Product shall fill-in the quantity, unit measure, unit price and total price for the Hawaii Product they desire to be considered for preference. Products not pre-approved shall not be considered. Hawaii Products not meeting the requirements of the specification shall not be considered.

Offerors selecting the Hawaii Product preference may be required to submit additional information on the cost basis of their selected Hawaii Product preference items when requested after the bid opening to verify cost of the Hawaii Products, including the computations for the estimated quantities, manufacturers, or supplier's quotations, and delivered material cost Free on Board (FOB) at the jobsite. The Hawaii Product Cost shall not include installation costs.

Hawaii Products available for this project are as follows:

Product Description	Class I, II or III	Manufacturer	Cost
			\$
			\$
			\$
			\$
			\$
			\$
			\$

CHARACTER OF WORKERS OR EQUIPMENT

The Contractor shall perform with his own organization, work amounting to not less than twenty percent (20%) of the total contract cost. The Engineer may require the Contractor to verify the percentage of work he will be providing with his own organization by furnishing pertinent information such as all of the actual subcontractor(s)' quotations he received for the bid. If requested, the Contractor shall provide such verification within 5 working days of the request.

CERTIFICATION FOR SAFETY AND HEALTH PROGRAM FOR BIDS IN EXCESS OF \$100,000

In accordance with HRS 396-18, by submitting this proposal, the undersigned certifies that his company will have a written safety and health plan for this project that will be available and implemented by the Notice to Proceed date of this project. Details of the requirements of this plan may be obtained from the Department of Labor and Industrial Relations, Occupational Safety and Health Division (HIOSH).

TAX CLEARANCES FROM THE STATE DIRECTOR OF TAXATION AND INTERNAL REVENUE SERVICE

Contractors are required to provide a state and federal tax clearance as a prerequisite to entering into a public contract of \$2,500 or more. To meet this requirement, all bidders shall submit valid tax clearances with their bid proposals when the bid is \$2,500 or more.

Failure to submit the required tax clearance may be sufficient grounds for the State to refuse to receive or consider the prospective bidder's proposal.

In accordance with Act 190 Amendment to HRS 103D-310(c), required as a prerequisite to entering into a contract, the contractor shall register on the Hawaii Compliance Express web site for all tax clearances by going to <http://vendors.ehawaii.gov> and registering there.

A Certificate of Vendor Compliance generated from this website should be included with their bid proposal. A Compliant status is required prior to awarding the contract.

LICENSE

Due to the nature of the work contemplated, bidder must possess a valid State of Hawaii Contractor's license in the appropriate classification – "B" as the General Contractor, automatically holds specialty classifications (ref. HAR Section 16-77-32c)

It is further agreed that:

1. The Adjutant General or his designated representative reserves the right to reject any and/or all bids and waive any defects when, in his opinion, such rejection or waiver will be in the best interest of the State.
2. The award of the contract shall be conditioned upon funds being made available for these projects and further upon the right of the Adjutant General or his designated representative to hold all bids received for a period of ninety (90) days from the date of the opening thereof, unless otherwise required by law, during which time no bid may be withdrawn.
3. The liquidated damages per working day for failure to complete the work on time shall be at **\$200.00** per calendar day or as stipulated in the General Conditions, whichever is higher.
4. By submitting this proposal, the undersigned is declaring his firm has not been assisted or represented on this matter by an individual who has, in a State capacity, been involved in the subject matter of this contract in the past two years.
5. Upon the acceptance of the proposal by the Adjutant General or his designated representative, the undersigned must enter into and execute a contract for the same and furnish a bond, as required by law. This bond shall conform to the provisions of Section 103D-324 of the Hawaii Revised Statutes and any law applicable thereto.
6. If the lowest bid received by the State exceeds the funds available for this project, the State reserves the right to negotiate with the lowest responsible bidder as permitted under Section 103D-302, Hawaii Revised Statutes, as amended, to reduce the scope of work and award a contract therefore.
7. This contract may be awarded as an informal contract as determined by the Adjutant General or his designated representative in accordance with the applicable Hawaii Revised Statutes as amended, whereby a purchase order will be executed and used as the formal contract.

Receipt of the following addenda issued by the Department is acknowledged by the day(s) of the receipt indicated below:

Addendum No. 1 _____ Addendum No. 2 _____
Date
Addendum No. 3 _____ Addendum No. 4 _____

It is understood that failure to receive any such addendum shall not relieve the Contractor from any obligation under this Proposal as submitted. (See Special Notice to Bidders for information regarding addenda.)

ALL JOINT CONTRACTORS & SUBCONTRACTORS TO ENGAGE ON THIS PROJECT

The bidder certifies that the following is a complete listing of all joint contractors or subcontractors covered under Chapter 444, Hawaii Revised Statutes, who will be engaged by the bidder on this project to perform the nature and scope of work indicated pursuant to Section 103D-302, Hawaii Revised Statutes, and understands that failure to comply with this requirement shall be just cause for rejection of the bid.

The bidder further certifies that only those joint contractors or subcontractors listed shall be allowed to perform work on this project and that all other work necessary shall be performed by the bidder with his own employees. If no joint contractor or subcontractor is listed, it shall be construed that all of the work shall be performed by the bidder with his own employees.

All bidders must be sure that they possess and that the subcontractors listed in the proposal possess all the necessary specialty licenses needed to perform the work for this project. The bidder shall be solely responsible for assuring that all of the specialty licenses required to perform the work is covered in his bid.

The bidder shall include the license number of the joint contractors or subcontractors listed below. Failure to provide the correct names and license numbers as registered with the Contractor's Licensing Board may cause rejection of the bid submitted.

Complete Firm Name of Joint Contractor or Subcontractor for Lump Sum Bid	License Number	Nature and Scope of Work to be performed
_____	_____	_____
_____	_____	_____
_____	_____	_____
_____	_____	_____
_____	_____	_____
_____	_____	_____
_____	_____	_____
_____	_____	_____
_____	_____	_____
_____	_____	_____
_____	_____	_____

Enclosed herewith as required by law:

- Surety Bond
 - Certificate of Deposit
 - Certified Check
 - Cashier's Check
 - Share Certificate
 - Legal Tender
- (Cross Out Those Not Applicable)

_____ DOLLARS (\$ _____).

*Signature _____ HAWAII GENERAL EXCISE TAX
Title _____ I.D. NO. _____

Name of Company _____

Address _____
_____ LICENSE CLASSIFICATION
_____ AND/OR SUBCLASSIFICATION
_____ NO.

Telephone _____

Date _____

(CORPORATE SEAL)

*Please attach to this page evidence of the authority of this officer to submit bids on behalf of the Company, and also the names and residence addresses of all officers of the Company.

NOTE: Fill in all blank spaces with the information asked for or bid may be invalidated.
PROPOSAL PAGES MUST BE INTACT; MISSING PAGES MAY INVALIDATE YOUR BID.

FORM 1

CERTIFICATION OF BIDDER'S PARTICIPATION IN APPROVED APPRENTICESHIP PROGRAM UNDER ACT 17

I. Bidder's Identifying Information			
A. Legal Business Name: _____			
B. Project Bid Title & Reference No.: _____			
C. Contact Person's Name: _____			
1. Phone No.: _____		2. E-Mail: _____	
II. Apprenticeable Trades To Be Employed*	B. Apprenticeship Sponsor*	C. No. Enrolled	D. No. Completed
A. (List)	(One Sponsor Per Form)	(# of apprentices currently enrolled as of bidder's request date)	(# of apprentices who completed the apprenticeship program in the 12 months prior to request date)
1.			
2.			
3.			
4.			
5.			
6.			
III. Bidder's Certification			
I certify that the above information is accurate to the best of my knowledge. I understand that my willful misstatement of facts may cause forfeiture of the preference under Act 17 and may result in criminal action. I give permission for outside sources to be contacted and for them to disclose any information necessary to verify the bidder's preference.			
_____		_____	
A. Name (Type)		B. Title	
_____		_____	
C. Signature (original signature required)		D. Date	
IV. Apprenticeship Sponsor's Contact Information			
A. Training Coordinator's Name: _____			
B. Address: _____			
C. Phone No.: _____		D. E-Mail: _____	
		E. Fax No: _____	
V. Apprenticeship Program Sponsor's Certification			
I certify that the above information is accurate to the best of my knowledge. I understand that my willful misstatement of facts may cause forfeiture of the bidder's preference and may result in criminal action. I give permission for outside sources to be contacted and for them to disclose any information necessary to verify the bidder's preference under Act 17.			
_____		_____	
A. Name of Authorized Official		B. Title	
_____		_____	
C. Signature (original signature required)		D. Date	

* Name of Apprenticeable Trade and Apprenticeship Sponsor must be the *same* as recorded in the List of Construction Trades in Registered Apprenticeship Programs that is posted on the State Department of Labor and Industrial Relations website.

(Name of Corporation)
Corporate Resolution

I, _____, Secretary of _____
Corporation,
a _____ Corporation, do hereby certify that the following is a full, true
and correct copy of a resolution duly adopted by the Board of Directors of said corporation, at its
meeting duly called and held at the office of the Corporation _____
Street, _____, on the _____ day of _____, 20__, at
which a quorum was present and acting throughout, and that said resolution has not been
modified, amended or rescinded and continues in full force and effect:

“RESOLVED that any individual at the time holding the position of President, Vice
President, Secretary or Treasurer be, and each of them hereby is, authorized to execute on behalf
of the Corporation any bid, proposal or contract for the sale or rental of the products of the
Corporation or for services to be performed by the Corporation, and to execute any bond
required by any such bid, proposal or contract with the United States Government or the State of
Hawaii or the City and County of Honolulu, or any County or Municipal Government of said
State, or any department or subdivision of any of them.

IN WITNESS WHEREOF, I have hereunto set my hand and affixed the corporate seal of said
_____ Corporation this _____ day of
_____, 20__.

Secretary

(Names and Address of:)

President:

Vice President:

Secretary:

Treasurer:

SPECIAL NOTICE TO BIDDERS - CONSTRUCTION

QUALIFICATIONS OF BIDDERS - Prospective bidders must be capable of performing the work for which bids are being called.

The Department of Defense no longer requires a submittal of "INTENTION TO BID" unless otherwise stated in the notice to bidders.

If two (2) or more prospective bidders desire to bid jointly as a joint venture on a single project, they must file an affidavit of joint venture with their notice of intention to bid or if no intent to bid is required, shall submit an affidavit of joint venture prior to bid opening. Such affidavit of joint venture will be valid only for the specific project for which it is filed. No further license is required when all parties to the joint venture possess current and appropriate contractor's licenses. Joint ventures are required to be licensed in accordance with Chapter 444 of the Hawaii Revised Statutes, as amended, and the rules and regulations of the Contractor's License Board when any party to the joint venture agreement does not hold a current or appropriate contractor's license.

The Adjutant General or his designated representative may, in accordance with Section 103D-310, Hawaii Revised Statutes, require the prospective bidder to submit answers to questions in the "Standard Questionnaire and Financial Statement for Bidders," on the form provided by the Department, properly executed and notarized, setting forth a complete statement of the experience of such prospective bidder and his organization in performing similar work and a statement of the equipment proposed to be used, together with adequate proof of the availability of such equipment, at least forty-eight (48) hours prior to the time advertised for the opening of bids. If the information in the questionnaire proves satisfactory, the bidder's proposal will be received. All information contained in the answers to the questionnaire shall be kept confidential. The questionnaire will be returned to the bidder after it has served its purpose.

If upon review of the Questionnaire, or otherwise, the bidder appears not fully qualified or able to perform the intended work, the Adjutant General or his designated representative shall, after affording the bidder an opportunity to be heard and if still of the opinion that the bidder is not fully qualified to perform the work, refuse to receive or to consider any bid offered by the prospective bidder.

Failure to complete the prequalification questionnaire, (IF SENT TO YOU), will be sufficient cause for the Department to disqualify a prospective bidder.

INTERPRETATION OF QUANTITIES IN BID SCHEDULE - When quantities for individual items of work are listed in the bid form for which respective unit prices are asked, said quantities are to be considered as approximate and are to be used by the Department only for the purpose of comparing on a uniform basis bids offered for the work. The Department does not, expressly or by implication, agree that the actual

quantity of work will correspond therewith. The undersigned agrees that his is satisfied with and will at no time dispute said estimated quantities as a means of comparing the bids.

After determining the low bidder by comparison of bids submitted in accordance with the proposal form, the Adjutant General or his designated representative reserves the right to increase or decrease the scope of the improvement.

On unit price bids, payment will be made only for the actual number of units incorporated into the finished project at the unit price bid.

It is understood and agreed that the contractor will make no claim for anticipated profit or loss of profit due to the Department's right to eliminate entirely portions of the work or to increase or decrease any or all of the quantities shown in the proposal form and/or scope of work.

CONTENTS OF CONTRACT FORMS – The Statement of Work will provide the location, description, and the contract time of the work contemplated for which a lump sum bid price is asked or containing a schedule of items, together with estimated quantities of work to be performed and materials to be furnished, for which unit bid prices and/or lump sum bid prices are asked.

Proposal forms will include a listing of joint contractor and/or subcontractors asking the name of each person or firm to be engaged on the project as a joint contractor or subcontractor.

All papers bound with or attached to the offer form shall be considered a part thereof and shall not be detached or altered when the bid is submitted.

The plans, specifications and other documents designated in the bid document package, will also be considered a part thereof whether attached or not.

BIDDERS RESPONSIBILITY FOR EXAMINATION OF PLANS, SPECIFICATIONS, SITE OF WORK, ETC. - The bidder shall examine carefully the site work contemplated and the proposal, plans, specifications, supplemental specifications, special provisions and contract and bond forms, therefore. The submission of a bid shall be considered as a warranty that the bidder has made such examination and is satisfied with the conditions to be encountered in performing the work and with the requirements of the plans, specifications, supplemental specifications, special provisions, contract, and bond.

No extra compensation will be given by reason of the Contractor's misunderstanding or lack of knowledge of the requirements of the work to be accomplished or the conditions to be encountered in performing the project.

Where an investigation of subsurface conditions has been made by the Department in respect to foundation or other design, the bidders may inspect the records of the Department as to such investigation, including examination of samples, if any. It is understood, however, that any such information furnished is for the bidders' convenience only and no assurance is given that conditions found at the time of subsurface investigation, such as the presence or absence of water, will be conditions that prevail at the time of construction.

When the contract plan includes a log of test borings showing a record of the data obtained by the Department's investigation of subsurface conditions, said log represents only the opinion of the Department as to the character of material encountered by it in its test borings and there is no warranty, either expressed implied, that the conditions indicated are representative of those existing throughout the work or any part of it, or that unforeseen developments may not occur.

Information regarding the site of work given on the drawings or specifications has been obtained by the Department and is believed to be reasonably correct, however, it is the responsibility of the bidder to verify all such information. Any utilities that the Contractor encounters during the progress of the work, such as telephone ducts, electric ducts, water lines, sewer lines, electric lines, and drainage pipes, whether shown or not on the contract plans, shall not be disturbed or damaged unless otherwise instructed in the plans and specifications.

In the event the utilities are damaged or disturbed by the Contractor, the Contractor shall be held liable for the damage or disturbed utilities which were:

- A. Shown on the plan.
- B. Located and exposed on the job as it progressed.
- C. Pointed out to the Contractor in the field.

The Contractor shall repair the damaged or disturbed utilities to the existing condition at no cost to the Department or the project. Any damage claims due to the disruption of service caused by the utilities being damaged shall be paid by the Contractor who shall save harmless the Department from all suits, actions, or claims of any character brought on account of such damages.

In the event utilities which were not shown on the plans and specifications are damaged or disturbed by the Contractor, the Contractor shall not be held liable but shall notify the Engineer. Upon instruction from the Engineer, the Contractor shall repair all damages which shall be considered to be additional work.

Utilities which must be relocated due to construction and not so indicated in the plans and specifications shall also be considered to be additional work. The Contractor shall not in any case, if he encounters underground utilities, proceed with any work until he has notified the Engineer.

No information derived from such inspection of records of subsurface investigations made by the Department or from the Engineer or from his authorized representative or from maps, plans, specifications, or drawings will in any way relieve the Contractor from any risk or from properly fulfilling all the terms of the contract. The log tests borings if included in the plans are only for the convenience of the bidder and do not constitute a part of the contract. The Contractor is solely responsible for all assumptions, deductions, or conclusions he may make or derive from the subsurface records furnished.

ADDENDA AND INTERPRETATIONS - Discrepancies, omissions, or doubts as to the meaning of drawings and specifications should be communicated via email as directed in the Notice to Bidders and must be received by the Engineering Office, Department of Defense, no later than the date stated in the Notice to Bidders for submittal of questions. Any interpretation, if made, and any supplemental instructions will be in the form of written addenda. All addenda will be posted on the State Procurement Office website <http://spo.hawaii.gov> . Failure of any bidder to receive any such addendum or interpretations shall not relieve such bidder from any obligation under his bid as submitted. All addenda so issued shall become part of the contract documents.

PREPARATION OF PROPOSAL - The bidder's proposal must be submitted on the proposal form furnished by the Department. The proposal must be prepared in full accordance with the instructions therein. The bidder must state, both in words and numerals, the lump sum price at which the work contemplated is proposed to be done. These prices must be written in ink or typed. Prices written in pencil are not acceptable. In case of a discrepancy between the prices written in words and those written in figures, the words shall govern over the figures. The bidder shall sign the proposal in the spaces provided with ink.

If the proposal is made by an individual, his name and post office address must be shown in the space provided. If made by a partnership, the name and post office address of each member of the partnership must be shown and the proposal signed by all partners or evidence in the form of a partnership agreement must be submitted showing the authority of the partner to enter on behalf of said partnership, into contract with the State. If made by a corporation, the proposal must show the name, titles, and business address of the president, secretary, and treasurer and also evidence in the form of a corporate resolution must be submitted showing the authority of the particular corporate representative to enter on behalf of said corporation into contract with the State. (See sample). If made by a joint venture the name and post office address of each member of the individual form, partnership or corporation comprising the joint venture must be shown with other pertinent information required of individuals, partnerships or corporations as the case may be. The proposal must be signed by all parties to the joint venture or evidence in the form of a Joint Venture Agreement must be submitted showing the authority of the Joint Venture's representative to enter on behalf of said Joint Venture into contract with the State.

Pursuant to the requirements of Section 103D-302, Hawaii Revised Statutes, each bidder shall include in his bid the name of each person or firm to be engaged by the bidder on the project as joint contractor or subcontractor indicating also the nature and scope of work to be performed by such joint contractor and/or subcontractor.

BID SECURITY - No proposal totaling \$25,000 or more will be considered unless accompanied by one of the following forms of bidder's security:

A. Surety bond underwritten by a company licensed to issue bonds in this State.

B. Legal Tender.

C. Certificate of Deposit; share certificate; or cashier's, treasurer's, tellers, or official check drawn by, or certified check accepted by, and payable on demand to the State by a bank, a savings institution, or credit union insured by the Federal Deposit Insurance Corporation or the National Credit Union Administration.

(1) These instruments may be utilized only to a maximum of \$100,000.

(2) If the required security amount totals over \$100,000, more than one instrument not exceeding \$100,000 each and issued by different financial institutions shall be accepted.

THE BID SECURITY SHALL BE AT LEAST FIVE (5) PERCENT OF THE BID AMOUNT.

If the bidder is a corporation, evidence in the form of a corporate resolution, authorizing the corporate representative to execute the bond must be submitted with the proposal. If the bidder is a partnership, all partners must sign the bond or evidence in the form of a partnership agreement must be submitted showing the authority of the partner.

If the bidder is a joint venture, all parties to the joint venture must sign the bond or evidence in the form of a joint venture agreement must be submitted showing the authority of the bidder to sign the bond on behalf of the joint venture.

In the case where the award will be made on a group or item basis, the amount of proposal guaranty shall be based on the total bid for all groups or items submitted.

Bidders are cautioned that surety bid bonds which place a limit in value to the difference between the bid amount and the next acceptable bid, such value not to exceed the purported amount of the bond, are acceptable. Also, surety bid bonds which place a time limit on the right of the State to make claim other than allowed by statutes or these General Conditions are not acceptable. Bidders are hereby notified that a surety bid bond containing such limitation(s) is not acceptable and a bidder's bid accompanied by such surety bid bond will be automatically rejected.

DELIVERY OF PROPOSALS - The entire proposal shall be placed together with the bid security, in a sealed envelope so marked as to indicate the identity of the project, the project number, the date of bid opening and the name and address of the bidder and then delivered as indicated in the Notice to Bidders. Bids which do not comply with this requirement may not be considered. Proposals will be received up to the time fixed in the public notice for opening of bids and must by that time be in the hands of the officials indicated. The words 'SEALED BID' must be clearly written or typed on the face of the sealed envelope containing the proposal guaranty.

WITHDRAWAL OR REVISION OF PROPOSALS - Any bid may be withdrawn or revised at any time prior to, but not after, the time fixed in the public notice for the opening of bids, provided that a request in writing, executed by the bidder or his duly authorized representative, for the withdrawal or revision of such bid is filed with the Adjutant General before the time set for the opening of bids. The withdrawal of a bid shall not prejudice the right of a bidder to file a new bid. Whether or not bids are opened exactly at the time fixed in the public notice for opening bids, a bid will not be received after that time, nor may any bid be withdrawn after the time fixed in the public notice for the opening of bids.

PUBLIC OPENING OF PROPOSALS - Proposals will be opened and read publicly at the time and place indicated in the Notice to Bidders. Bidders, their authorized agents, and other interested parties are invited to be present.

DISQUALIFICATION OF BIDDERS - Any one or more of the following causes will be considered as sufficient for the disqualification of a bidder and the rejection of his proposal or proposals:

- A. Non-compliance with "QUALIFICATION OF BIDDERS".
- B. Evidence of collusion among bidders.
- C. Lack of responsibility and cooperation as shown by past work.
- D. Being in arrears on existing contracts with the State of Hawaii or having defaulted on a previous contract.
- E. Lack of proper equipment and/or sufficient experience to perform the work contemplated as revealed by the Standard Questionnaire and Financial Statement for Bidders.
- F. No contractor's license or a contractor's license which does not cover type of work contemplated.
- G. More than one proposal for the same work from an individual, firm, partnership, corporation, or joint venture under the same or different name.

H. Delivery of bids after the deadline specified in the advertisement calling for bids.

I. Failure to pay, or satisfactorily settle, all bids overdue for labor and material on former contracts in force at the time of issuance of proposal forms.

CONSIDERATION OF PROPOSALS - After the proposals are opened and read, the figures will be extended and/or totaled in accordance with the bid prices of the acceptable proposals and the totals will be compared and the results of such comparison shall immediately be made public. In the comparison of bids, words written in the proposals will govern over figures and unit prices will govern over totals. Until the award of the contract, however, the right will be reserved to reject any and all proposals and to waive any defects or technicalities as may be deemed best for the interest of the State.

IRREGULAR PROPOSALS - Proposals will be considered irregular and may be rejected for the following reasons:

A. If the proposal is unsigned.

B. Bid security not in accordance with paragraph "BID SECURITY".

C. If proposal is on a form other than that furnished by the Department or if the form is altered or any part thereof detached.

D. If the proposal shows any non-compliance with applicable law, alteration of form, additions not called, conditional bids, incomplete bids, uninitiated erasures, other defects, or if the prices are obviously unbalanced, or if sufficient funds are not available to prosecute the work.

E. If the bidder adds any provisions reserving the right to accept or reject an award, or to enter into a contract pursuant to an award.

This does not exclude a proposal limiting the maximum gross amount of awards acceptable to any one bidder at any one bid letting, provided that any selection of awards will be made by the Department.

F. When a proposal is signed by an officer or officers of a corporation and a currently certified corporate resolution authorizing such signer(s) to submit such proposal is not submitted with the proposal or when the proposal is signed by an agent other than the officer or officers of a corporation, or a member of a partnership and a Power of Attorney is not submitted with the proposal.

G. Where there is an incomplete or ambiguous listing of joint contractors and/or subcontractors the proposal may be rejected. All work which is not listed as being performed by joint contractor and/or subcontractors must be performed by the bidder

with his own employees. Additions to the list of joint contractors or subcontractors will not be allowed. Whenever there is a doubt as to the completeness of the list, the bidder will be required to submit within five (5) working days, written confirmation that the work in question will be performed with his own force. Whenever there is more than one joint contractor and/or subcontractor listed for the same item of work, the bidder will be required to either confirm in writing within five (5) working days that all joint contractors or subcontractors listed will actually be engaged on the project or obtain with five (5) working days, written releases from those joint contractor and/or subcontractors who will not be engaged.

AWARD OF CONTRACT - The award of contract, if it be awarded, will be made within ninety (90) consecutive calendar days after the opening of the proposals to the lowest responsible and responsive bidder (including the alternate or alternates which may be selected by the Adjutant General in the case of alternate bids) whose proposal complies with all the requirements prescribed, but in no case will an award be made until all necessary investigations are made. The successful bidder will be notified, by letter mailed to the address shown on the proposal that his bid has been accepted and that he has been awarded the contract.

No contract will be awarded to any person or firm suspended under the provisions of Chapter 104 and Chapter 444, Hawaii Revised Statutes, as amended.

CANCELLATION OF AWARD - The Adjutant General or his designated representative reserves the right to cancel the award of any contract at any time before the execution of said contract by all parties without any liability to the awardee and to any other bidder.

RETURN OF BID SECURITY (excluding bid bonds) - All bid securities, except those of the four (4) lowest bidders, will be returned immediately following the opening and checking of the proposals. The retained bid securities of the remaining two (2) lowest bidders will be returned within five (5) working days following the execution of contract. The successful bidder's bid security may be returned after a satisfactory contract bond has been furnished and the contract has been executed.

RETURN OF BID BONDS – The bid bonds will be returned only after receipt of a written request from the contractor.

REQUIREMENT OF PERFORMANCE AND PAYMENT BONDS - Performance and Payment Bonds shall be required for contracts exceeding \$50,000. At the time of the execution of the contract, the successful bidder shall file a good and sufficient performance and payment bonds on the form furnished by the Department or the contractors Surety, each in an amount equal to one hundred percent (100%) of the amount of the contract price unless otherwise stated in the solicitation of bids. Acceptable performance and payment bonds shall be limited to the following:

- A. Surety bond underwritten by a company licensed to issue bonds in this State; or

B. Legal Tender; or

C. A certificate of deposit; share certificate; or cashier's, treasurer's, tellers, or official check drawn by, or a certified check accepted by, and payable on demand to the State by a bank, a savings institution, or credit union insured by the Federal Deposit Insurance Corporation or the National Credit Union Administration.

(1) These instruments may be utilized only to a maximum of \$100,000.

(2) If the required security or bond amount totals over \$100,000, more than one instrument not exceeding \$100,000 each and issued by different financial institutions shall be acceptable.

If the contractor fails to deliver the required performance and payment bonds, the contractor's award shall be canceled, its bid security enforced, and award of the contract shall be made to the next lowest bidders.

EXECUTION OF THE CONTRACT - The contract shall be signed by the successful bidder and returned, together with a satisfactory performance and payment bonds, within ten (10) consecutive calendar days, after the bidder has received his contract for execution or within such further time as the Adjutant General or his designated representative may allow. No proposal or contract shall be considered binding upon the State until the contract has been fully and properly executed by all parties thereto and the Adjutant General or his designated representative has endorsed therein his certificate, as required by Section 103D-309, Hawaii Revised Statutes, that there is an available unexpended appropriation or balance of an appropriation over and above all outstanding contracts sufficient to cover the State's amount required by such contract.

On any individual award totaling less than \$50,000, the State reserves the right to execute the contract by the issuance of a State Purchase Order. Acceptance shall result in a binding contract between the parties without further action by the State. Executing the contract by Purchase Order shall not be deemed a waiver of these specification requirements.

FAILURE TO EXECUTE THE CONTRACT - If the bidder to whom a contract is awarded shall fail or neglect to enter into the contract and to furnish satisfactory security within ten (10) consecutive calendar days after such award or within such further time as the Adjutant General or his designated representative may allow, the award shall be canceled, and the bid security shall be declared forfeited. The bid security shall thereupon become a realization of the State, not as a penalty, but in liquidation of the damages sustained. The Adjutant General may thereupon award the contract to the next lowest responsible bidder or may call for new bids, whichever method he may deem is to the best interest of the State.

NOTICE TO PROCEED - After the contract is fully executed, the Contractor will be sent a formal "Notice to Proceed" advising the Contractor of the date on which he may proceed with the work. The Contractor shall be allowed ten (10) consecutive working days from said date to begin his work. In the event that the Contractor refuses or neglects to start the work, the Adjutant General or his designated representative may terminate the contract.

SPECIAL PROVISIONS FOR CONSTRUCTION CONTRACTS

RESPONSIBILITY OF OFFERORS

Offeror shall furnish proof of compliance in accordance with Act 190 Amendment to HRS 103D-310(c)

Required as a prerequisite to entering into a contract, the contractor shall register on the Hawaii Compliance Express web site for all tax clearances by going to <http://vendors.ehawaii.gov> and registering there.

A Certificate of Vendor Compliance generated from this website should be included with their bid proposal. A Compliant status is required prior to awarding the contract.

COMPREHENSIVE ANNUAL FINANCIAL REPORTING

For any project that involves work on multiple structures, including non-building structures, whether it be new work or renovation work, or when the project involves both site improvements and a structure, the Contractor shall provide the following information to the Project Manager for fixed asset allocation purposes:

1. Within 30 calendar days of award as applicable to the project, the following shall be submitted:
 - a. The total cost of each individual structure.
 - b. The total cost of on-site improvement work; and
 - c. The total cost of off-site improvement work.
2. After all work, including all change order work has been completed, and prior to a request for final payment, the following shall be submitted:
 - a. The total cost of each individual structure including any related change order cost.
 - b. The total cost of on-site improvement work including any related change order cost; and
 - c. The total cost of off-site improvement work including any related change order cost.
3. The sum total cost of each category noted above shall total to the contract amount awarded, plus all change order work issued.
 - a. The cost of each individual structure includes the cost of the structure and any work within five (5) feet of the structure or building line which may include, but is not limited to its foundation, foundation earthwork, and utility improvements within and immediately below the building line.
 - b. The on-site improvement cost includes all site improvement work from

five (5) feet and beyond the building line and up to the project's property line, which may include but is not limited to clearing and grubbing, grading, drainage system, site utility, walkway, parking lot, and landscape improvements.

- c. The off-site improvement cost includes all off-site improvement work outside of the project's property line, which may include but is not limited to walkway, landscape, drainage, utility, and roadway improvements.

LIABILITY INSURANCE

The Contractor shall not commence any work until it obtains, at its own expense, all required liability insurance. Such insurance must have the approval of the State as to limit form and amount and must be maintained with a company acceptable to the State. Such insurance must be maintained for the full period of the contract and shall provide protection from claims arising out of or resulting from the Contractor's operations under the Contract itself Subcontractor or by anyone directly or indirectly employed by any of them or by anyone for whose acts any of them may be liable.

The contractor shall take out and maintain during the life of this contract broad form public liability (Bodily Injury) and broad form property damage liability insurance in a combined single limit not less than \$1,000,000 and not less than \$2,000,000 in the aggregate to protect such contractor and all his subcontractors from claims for damages for personal injury, accidental death and property damage which may arise from operations under this contract, whether such operations be by himself or anyone directly or indirectly employed by either of them and to include automotive liability, workers compensation and employers liability.

The insurance described herein will be maintained by the Contractor for the full period of the Contract and in no event will be terminated or otherwise allowed to lapse prior to final acceptance of the work by the State.

A certificate of insurance acceptable to the State shall be filed with the State prior to commencement of the work. Such certificate shall contain a provision that coverage afforded under the policy will not be canceled or changed until at least thirty days written notice has been given to the State by registered mail at the address denominated for the State in the Contract for official communications to it should any policy be canceled before final acceptance by the State, and the Contractor fails to immediately procure replacement insurance as specified, the State reserves the right to procure such insurance and to deduct the cost thereof from any sum due the Contractor.

BID PREPARATION

Offer Form, Page Of-1. Offeror is requested to submit its offer using Offeror's exact legal name as registered with the Department of Commerce and Consumer Affairs, if applicable; and to indicate exact legal name in the appropriate space on Offer Form, page OF-1. Failure to do so may delay proper execution of the contract.

The authorized signature on the first page of the Offer Form shall be an original signature in ink. If unsigned or the affixed signature is a facsimile or a photocopy, the offer shall be automatically rejected unless accompanied by other material, containing an original signature, indicating the Offeror's intent to be bound.

Hawaii Business. A business entity referred to as a "Hawaii business", is registered and incorporated or organized under the laws of the State of Hawaii.

Compliant non-Hawaii business. A business entity referred to as a "compliant non-Hawaii business," is not incorporated or organized under the laws of the State of Hawaii but is registered to do business in the State.

Tax Liability. Work to be performed under this solicitation is a business activity taxable under Chapter 237, Hawaii Revised Statutes (HRS), and vendors are advised that they are liable for the Hawaii GET at the current rate.

4.712% tax rate. All businesses located on Oahu are required to pay the ½% County Surcharge tax on all Oahu transactions for which they pay the 4% GE tax. Neighbor island and out-of-state businesses that deliver goods or services to Oahu and have a 'physical presence' on Oahu, must pay the new ½% County Surcharge tax on their Oahu transactions.

4% tax rate. Neighbor island and out-of-state businesses that do not deliver any goods or services to Oahu are not subject to the new ½% County Surcharge tax.

If, however, an Offeror is a person exempt by the HRS from paying the GET and therefore not liable for the taxes on this solicitation, Offeror shall state its tax-exempt status and cite the HRS chapter or section allowing the exemption.

Taxpayer Preference. For evaluation purposes, pursuant to §103D-1008, HRS, the Bidder's tax-exempt price offer submitted in response to an IFB shall be increased by the applicable retail rate of general excise tax and the applicable use tax. Under no circumstance shall the dollar amount of the award include the aforementioned adjustment.

AWARD OF CONTRACT

Method of Award. Award, if made, shall be to the responsive, responsible offeror submitting the lowest Lump Sum Bid unless otherwise noted in the bid documents.

Responsibility of Lowest Responsive Bidder. Reference Responsibility of Offerors in §3-122-112, HAR. If compliance documents have not been submitted to the State Department of Defense prior to award, the lowest responsive offeror shall produce documents to the procurement officer to demonstrate compliance with this section.

HRS Chapter 237 tax clearance requirement for award and final payment.

Instructions are as follows:

In accordance with Act 190 Amendment to HRS 103D-310(c)

Required as a prerequisite to entering into a contract, the contractor shall register on the Hawaii Compliance Express web site for all tax clearances by going to <http://vendors.ehawaii.gov> and registering there.

A Certificate of Vendor Compliance generated from this website should be included with their bid proposal. A Compliant status is required prior to awarding the contract.

A current Certificate of Vendor Compliance must accompany the invoice for final payment on the contract.

HRS Chapters 383 (Unemployment Insurance), 386 (Workers' Compensation), 392 (Temporary Disability Insurance), and 393 (Prepaid Health Care) requirements for award. Instructions are as follows:

Pursuant to §103D-310(c), HRS, The Certificate of Vendor Compliance must have a "Compliant" rating with the DLIR.

Compliance with Section 103D-310(c)(1) and (2), HRS.

Contractors are required to provide a state and federal tax clearance as a prerequisite to entering into a public contract of \$2,500 or more. To meet this requirement, all bidders shall submit valid tax clearances with their bid proposals when the bid is \$2,500 or more.

In accordance with Act 190 Amendment to HRS 103D-310(c), required as a prerequisite to entering into a contract, the contractor shall register on the Hawaii Compliance Express web site for all tax clearances by going to <http://vendors.ehawaii.gov> and registering there.

A Certificate of Vendor Compliance generated from this website shall be included with their bid proposal. A Compliant status is required prior to awarding the contract.

Failure to submit the required tax clearance will be sufficient grounds for the State to refuse to receive or consider the prospective bidder's proposal.

The Certificate of Vendor Compliance should be applied for as soon as possible. If a valid certificate is not submitted on a timely basis for award of a contract, an offer otherwise responsive and responsible may not receive the award.

Final Payment Requirements. A current Certificate of Vendor Compliance will be required for final payment.

SPECIAL PROVISIONS for Act 68, SLH 2010, CONSTRUCTION CONTRACTS

DEFINITIONS FOR TERMS USED IN ACT 68, SLH 2010:

- a. "Contract" means contracts for construction under 103D, HRS.
- b. "Contractor" has the same meaning as in section 103D-104, HRS, provided that "contractor" includes a Subcontractor where applicable.
- c. "Construction" has the same meaning as in section 103D-104, HRS.
- d. "Procurement Officer" has the same meaning as in section 103D-104, HRS.
- e. "Resident" means a person who is physically present in the State of Hawaii at the time the person claims to have established the person's domicile in the State of Hawaii and shows the person's intent is to make Hawaii the person's primary residence.
- f. "Shortage trade" means a construction trade in which there is a shortage of Hawaii residents qualified to work in the trade as determined by the Department of Labor and Industrial Relations.

EMPLOYMENT OF STATE RESIDENTS' REQUIREMENTS – ACT 68, SLH 2010:

- a. A Contractor awarded a contract shall ensure that Hawaii residents compose not less than eighty percent of the workforce employed to perform the contract work on the project. The eighty percent requirement shall be determined by dividing the total number of hours worked on the contract by Hawaii residents, by the total number of hours worked on the contract by all employees of the contractor in the performance of the contract. The hours worked by any Subcontractor of the Contractor shall count towards the calculation for this section. The hours worked by employees within shortage trades, as determined by the Department of Labor and Industrial Relations (DLIR), shall not be included in the calculation for this section.

- b. Prior to starting any construction work, the Contractor shall submit the subcontract dollar amount for each of its Subcontractors.
- c. The requirements of this section shall apply to any subcontract of \$50,000 or more in connection with the Contractor, that is, such Subcontractors must also ensure that Hawaii residents compose not less than eighty percent of the Subcontractors workforce used to perform the subcontract.
- d. The Contractor and any Subcontractor whose subcontract is \$50,000 or more shall comply with the requirements of Act 68 for the entire duration of the contract.
 - 1. Certification of Compliance for Employment of State Residents (attached) shall be made prior to submittal of the final invoice.
 - 2. The Certification of Compliance for Employment of State Residents shall be made under oath by an officer of the company by completing a Certification of Compliance for Employment of State Residents form and executing the Certificate before a licensed notary public.
 - 3. In addition to the certification as required above, the Contractor and Subcontractors shall maintain records such as certified payrolls for laborers and mechanics who performed work at the site and time sheets for all other employees who performed work on the project. These records shall include the names, addresses and number of hours worked on the project by all employees of the Contractor and Subcontractor who performed work on the project to validate compliance with Act 68. The Contractor and Subcontractors shall retain these records and provide access to the State for a minimum period of four (4) years after the final payment, except that if any litigation, claim, negotiation, investigation, audit or other action involving the records has been started before the expiration of the four (4) year period, the Contractor and Subcontractors shall retain the records until completion of the action and resolution of all issues that arise from it, or until the end of the four (4) year period, whichever occurs later. Furthermore, it shall be the Contractor's responsibility to enforce compliance with this provision by any Subcontractor.
- e. A Contractor who fails to comply with this section shall be subject to any of the following sanctions:
 - 1. Temporary suspension of work on the project until the Contractor or its Subcontractor complies with Act 68.
 - 2. Withholding of payment on the contract until the Contractor or its Subcontractor complies with Act 68.

3. Permanent termination of the Contractor or Subcontractor from any further work on the project.
4. Recovery by the State, as applicable, of any moneys expended on the contract or subcontract as applicable; or
5. Proceedings for debarment or suspension of the Contractor or Subcontractor under Hawaii Revised Statutes §103D-702.

Conflict with Federal Law:

This section shall not apply if the application of this section is in conflict with any federal law, or if the application of this section will disqualify the State from receiving Federal funds or aid.

Davis-Bacon Act:

Davis-Bacon Act prevailing wage rates apply to all State of Hawaii Construction contracts over \$2,000.00.

**CERTIFICATION OF COMPLIANCE
FOR
EMPLOYMENT OF STATE RESIDENTS
HRS CHAPTER 103B, AS AMENDED BY ACT 192, SLH 2011**

Project Title: _____

Agency Project No: _____

Contract No.: _____

As required by Hawai'i Revised Statutes Chapter 103B, as amended by Act 192, Session Laws of Hawaii 2011-Employment of State Residents on Construction Procurement Contracts, I hereby certify under oath, that I am an officer of _____ and
(Name of Contractor or Subcontractor Company)
for the Project Contract indicated above, _____ was in
(Name of Contractor or Subcontractor Company)
compliance with HRS Chapter 103B, as amended by Act 192, SLH 2011, by employing a workforce of which not less than eighty percent are Hawai'i residents, as calculated according to the formula in the solicitation, to perform this Contract.

I am an officer of the **Contractor** for this contract.

I am an officer of the **Subcontractor** for this contract.

CORPORATE SEAL

(Name of Company)

(Signature)

(Print Name)

(Print Title)

Subscribed and sworn to me before this _____ day of _____, 2011.

Doc. Date: _____ # of Pages _____ 1st Circuit

Notary Name: _____

Doc. Description: _____

Notary Public, 1st Circuit, State of Hawai'i
My commission expires: _____

Notary Signature Date

NOTARY CERTIFICATION

SURETY BID BOND

Bond No.

KNOW TO ALL BY THESE PRESENTS:

That we, _____

[Full name or legal title of bidder]

as Offeror, hereinafter called Principal, and _____

[Bonding Company]

_____,
as Surety, hereinafter called Surety, a corporation authorized to transact business as a Surety in the State of Hawaii,
are held and firmly bound unto the State of Hawaii, Department of Defense, as Owner, hereinafter called owner, in
the penal sum of _____

_____ Dollars (\$_____),

[Required amount of bid security]

lawful money of the United States of America, for the payment of which sum well and truly to be made, the said
Principal and the said Surety bind ourselves, our heirs, executors, administrators, successors and assigns, jointly
and severally, firmly by these presents.

WHEREAS:

The Principal has submitted an offer for _____

[Project number and Title]

NOW, THEREFORE:

The condition of this obligation is such that if the Owner shall reject said offer, or in the alternate, accept
the offer of the Principal and the Principal shall enter into a Contract with the Owner in accordance with the terms
of such offer, and give such bond or bonds as may be specified in the solicitation or Contract Documents with good
and sufficient surety for the faithful performance of such Contract and for the prompt payment of labor and material
furnished in the prosecution thereof as specified in the solicitation then this obligation shall be null and void,
otherwise to remain in full force and effect.

Signed this _____ day of _____, 20____.

(Seal)

Name of Principal

Signature

Title _____

(Seal)

Name of Surety

Signature

Title _____

TABLE OF CONTENTS

Section/Subsection	Page	Section/Subsection	Page
ARTICLE 1 - DEFINITIONS	1	4.4 Price Adjustment	14
ARTICLE 2 - PROPOSAL REQUIREMENTS AND CONDITIONS		4.5 Allowances for Overhead and Profit	15
2.1 Qualification of Bidders	5	4.6 Payment for Deleted Material	15
2.1.1 Notice of Intention to Bid.....	5	4.6.1 Canceled Orders.....	15
2.1.2 Compliance Certificate.....	5	4.6.2 Returned Materials.....	15
2.1.3 Wrongful Refusal to Accept a Bid.....	6	4.6.3 Uncancelled Materials.....	15
2.2 Interpretation of Quantities in Bid Schedule	6	4.7 Variations in Estimated Quantities	15
2.3 Contents of Proposal Forms	6	4.8 Variations in Bottom Elevations	15
2.4 The Site and Proposed Contract Documents	6	4.9 Differing Site Conditions	16
2.5 Addenda and Bid Clarifications	7	4.10 Utilities and Services	16
2.5.3 Bid Discrepancy.....	7	4.10.2 Unknown Utilities.....	16
2.6 Substitution of Materials and Equipment Before Bid Opening	7	4.10.4 Restoration of Damaged Utilities.....	16
2.6.3 Statement of Variances.....	7	ARTICLE 5 - CONTROL OF WORK	
2.6.4 Substitution Denial.....	7	5.1 Authority of the Engineer	17
2.7 Preparation of Proposal	7	5.2 Authority of the Inspector	17
2.8 Bid Security	8	5.3 Authority of the Consultant(s)	17
2.9 Delivery of Proposals	9	5.4 Shop Drawings and Other Submittals	17
2.10 Withdrawal or Revision of Proposal	9	5.4.1.1 Shop Drawings.....	17
2.10.1 Withdrawal of Proposals.....	9	5.4.2 Submittal Variances.....	18
2.10.2 Modification of Proposals.....	9	5.4.3 Review and Acceptance Process.....	18
2.11 Public Opening of Proposals	9	5.5 Coordination of Contract Documents	19
2.12 Disqualification of Bidders	9	5.5.1 Addenda.....	19
2.13 Protest	9	5.5.2 Special Conditions and Proposal.....	19
ARTICLE 3 - AWARD AND EXECUTION OF CONTRACT		5.5.3 Specifications.....	19
3.1 Consideration of Proposals; Cancellation	10	5.5.4 Specification Error.....	19
3.2 Irregular Proposals	10	5.5.5 Drawings.....	19
3.3 Correction of Bids and Withdrawal of Bids	10	5.6 Interpretation of Drawings and Specifications	20
3.4 Award of Contract	11	5.7 Examination of Drawings, Specifications, Project Site	20
3.5 Cancellation of Award	11	5.8 Cooperation Between the Contractor and the Department	20
3.6 Return of Bid Security	11	5.8.1 Furnishing Drawings and Specifications.....	20
3.7 Requirement of Performance and Payment Bonds	11	5.8.2 Superintendent.....	20
3.8 Campaign Contributions by State and County Contractors	11	5.8.3 Engineering Work.....	20
3.9 Execution of the Contract	11	5.8.4 Use of Structure or Improvement.....	21
3.10 Failure to Execute the Contract	12	5.9 Inspection	21
3.11 Notice to Proceed	12	5.9.2 Authority to Suspend Operations.....	21
ARTICLE 4 - SCOPE OF WORK		5.9.4 Federal Agency Inspection.....	21
4.1 Intent of Contract, Duty of Contractor	12	5.10 Removal of Defective, Non-Conforming and Unauthorized Work	21
4.2 Changes	12	5.10.2 Scheduling Corrective Work.....	22
4.2.1 Minor Changes.....	12	5.10.3 Failure to Correct Work.....	22
4.2.2 Oral Orders.....	13	5.11 Value Engineering Incentive	22
4.2.3 Field Orders.....	13	5.11.2 Value Engineering Change Proposal.....	22
4.2.4 Change Orders.....	13	5.11.3 VECP Required Information.....	22
4.3 Duty of Contractor to Provide Proposal for changes	13	5.11.4 Required Use of Licensed Architect or Engineer.....	22
		5.11.6 Acceptance of VECP.....	22
		5.11.7 VECP Price Adjustments.....	23
		5.12 Subcontracts	23
		5.12.1 Replacing Subcontractors.....	23
		5.12.2 Notice of Replacing Subcontractor.....	23
		5.12.4 Subcontracting.....	24

Section/Subsection	Page
ARTICLE 6 - CONTROL OF MATERIALS AND EQUIPMENT	
6.1 Materials and Equipment	24
6.2 Source of Supply and Quality of Materials	24
6.2.3 Engineer’s Authorization to Test Materials	24
6.2.4 Unacceptable Materials.....	24
6.3 Substitution After Contract Award	24
6.3.2 Substitution After Contract Award	24
6.4 Asbestos Containing Materials	25
6.5 Test Samples	25
6.6 Material Samples	25
6.7 Non-Conforming Materials	26
6.8 Handling Materials	26
6.9 Storage of Materials	26
6.10 Property Rights in Materials	26
6.11 Assignment of Antitrust Claims for Overcharges for Goods Purchased	26

ARTICLE 7 - PROSECUTION AND PROGRESS

7.1 Prosecution of the Work	26
7.1.4 Working Prior to Notice to Proceed.....	26
7.2 Commencement Requirements	27
7.2.1 Identification of the Superintendent.....	27
7.2.2 Proposed Working Hours.....	27
7.2.3 Permits and Licenses.....	27
7.2.4 Schedule of Prices.....	27
7.2.5 Proof of Insurance Coverage.....	27
7.3 Insurance Requirements	27
7.3.1 Obligation of the Contractor.....	27
7.3.7 Types of Insurance.....	28
7.4 Permits and Licenses	28
7.5 Normal Working Hours	28
7.6 Hours of Labor	29
7.7 Prevailing Wages	29
7.7.2 Wage Rate Schedule	29
7.7.4 Posting Wage Rate Schedule	29
7.8 Failure to Pay Required Wages	29
7.9 Payrolls and Payroll Records	29
7.9A Apprenticeship Agreement Certification	30
7.10 Overtime and Night Work	30
7.10.2 Overtime Notification	30
7.11 Overtime and Night Payment for State Inspection Service	31
7.11.2 Payment for Inspection Services.....	31
7.12 Limitations of Operations	31
7.13 Assignment or Change of Name	31
7.13.1 Assignment	31
7.13.3 Recognition of a Successor in Interest; Assignment	32
7.13.4 Change of Name	32
7.14 Laws to be Observed	32
7.15 Patented Devices, Materials and Processes	32
7.16 Sanitary, Health and Safety Provisions	32
7.17 Protection of Persons and Property	33
7.17.1 Safety Precautions and Programs.....	33

Section/Subsection	Page
7.17.8 Emergencies	33
7.18 Archaeological Sites	33
7.19 Responsibility for Damage Claims; Indemnity	34
7.20 Character of Workers or Equipment	34
7.20.2 Character and Proficiency of Workers.....	34
7.20.3 Insufficient Workers.....	34
7.20.4 Equipment Requirements	35
7.21 Contract Time	35
7.21.1 Calculation of Contract Time	35
7.21.3 Modifications of Contract Time	35
7.21.4 Delay for Permits.....	35
7.21.5 Delays Beyond Contractor’s Control.....	35
7.21.6 Delays in Delivery of Materials.....	36
7.21.7 Delays for Suspension of Work.....	36
7.21.8 Contractor Caused Delays	36
7.21.9 Reduction in Time	37
7.22 Construction Schedule	37
7.23 Statement of Working Days	37
7.24 Suspension of Work	37
7.24.1 Procedure to be Followed.....	37
7.24.2 Partial, Total Suspension of Work.....	37
7.24.3 Payment.....	37
7.24.4 Claims Not Allowed.....	38
7.25 Disputes and Claims	38
7.25.1 Required Notification	38
7.25.2 Continued Performance of Work.....	38
7.25.4 Requirements for Notice of Claim.....	38
7.25.6 Final Statement for Claim	39
7.25.10 Decision on Claim / Appeal.....	39
7.25.11 Payment and Interest	39
7.26 Failure to Complete the Work on Time	39
7.26.2 Acceptance of Liquidated Damages	40
7.26.3 Payments for Performance Liquidated Damages	40
7.27 Termination of Contract for Cause	40
7.27.1 Default.....	40
7.27.2 Additional Rights and Remedies	40
7.27.3 Costs and Charges	40
7.27.4 Erroneous Termination for Cause.....	41
7.28 Termination for Convenience	41
7.28.1 Termination	41
7.28.2 Contractor’s Obligations	41
7.28.3 Right to Construction and Goods	41
7.28.4 Compensation.....	41
7.29 Correcting Defects	42
7.30 Final Cleaning	42
7.31 Substantial Completion, and Final Inspection	42
7.31.1 Substantial Completion	42
7.31.2 Final Inspection	42
7.31.4 Revoking Substantial Completion.....	42
7.32 Project Acceptance Date	42
7.32.2 Protection and Maintenance	43
7.32.4 Punch List Requirements.....	43
7.32.7 Failure to Correct Deficiencies.....	43
7.33 Final Settlement of Contract	43

Section/Subsection	Page
7.33.1 Necessary Submissions	43
7.33.2 Failure to Submit Closing Documents	43
7.34 Contractor's Responsibility for Work; Risk of Loss	43
7.35 Guarantee of Work	44
7.35.2 Repair of Work	44
7.35.3 Manufacturer's and Installer's Guarantee	44
7.36 Work of and Charges by Utilities	44
7.37 Right to Audit Records	44
7.38 Records Maintenance, Retention and Access	45

ARTICLE 8 - MEASUREMENT AND PAYMENT

8.1 Measurement of Quantities	45
8.2 No Waiver of Legal Rights	45
8.3 Payment for Additional Work	46
8.3.4 Force Account Method	46
8.4 Progress and / or Partial Payments	49
8.4.1 Progress Payments	49
8.4.3 Payments for Materials	49
8.5 Prompt Payment	49
8.6 Retainage	50
8.7 Warranty of Clear Title.....	51
8.8 Final Payment	51
8.9 Claims Arising out of Payment for Required Work	51

ARTICLE 9- CONFIDENTIALITY OF PERSONAL INFORMATION

9.1 Definitions.....	52
9.2 Confidentiality of Material.....	52
9.3 Security Awareness Training and Confidentiality Agreements	52
9.4 Termination for Cause	52
9.5 Records Retention.....	52

SAMPLE FORMS

Request for Substitution
Name of Corporation
Weekly Quality Control Report Form

ARTICLE 1 - Definitions

Whenever the following terms or pronouns are used in these Bidding and Execution of Contract Requirements, and General Conditions, or in any contract documents or instruments where these Bidding and Execution of Contract Requirements, and General Conditions govern, the intent and meaning shall be interpreted as follows

- 1.1_ ADDENDUM (plural - Addenda) A written or graphic document, including Drawings and Specifications, issued by the Engineer during the bidding period which modify or interpret the bidding documents, by additions, deletions, clarifications or corrections which shall be considered and made a part of the bid proposal and the contract when executed.
- 1.2_ ADDITION (to the contract sum) Amount added to the contract Sum by Change Order.
- 1.3_ ADMINISTRATIVE RULES - Hawaii Administrative Rules for Chapter 103-D of the Hawaii Revised Statutes.
- 1.4_ ADMINISTRATOR - The Public Works Administrator, Department of Accounting and General Services
- 1.5_ ADVERTISEMENT - A public announcement soliciting bids or offers.
- 1.6_ AMENDMENT - A written document properly executed by the Contractor and DOD issued to amend the existing contract between the State and the Contractor.
- 1.7_ BAD WEATHER DAY - When weather or other conditions prevent a minimum of four hours of work with the Contractor's normal work force on controlling items of work at the site.
- 1.8_ BENEFICIAL OCCUPANCY - The point of project completion when the State can use the constructed facility in whole or in part for its intended purpose even though substantial completion may not be achieved.
- 1.9_ BID See OFFER
- 1.10_ BID SECURITY - The security furnished by the bidder from which the State may recover its damages in the event the bidder breaches its promise to enter into a contract with the State and fails to execute the required bonds covering the work contemplated, if its proposal is accepted.
- 1.11_ BIDDER - See Offeror
- 1.12_ BIDDING DOCUMENTS (or SOLICITATION DOCUMENTS) - The advertisement solicitation notice and instructions, Offer requirements, Offer forms, and the proposed contract documents including all addenda, and clarifications issued prior to receipt of the Offer.
- 1.13_ BULLETIN - A written notice to the Contractor requesting a price and / or time proposal for contemplated changes preparatory to the issuance of a field order or change order.
- 1.14_ BY OR TO THE ENGINEER - To avoid cumbersome and confusing repetition of expressions in these General Conditions, it is provided that whenever the following words or words of like import are used, they shall be understood as if they were followed by the words "by the Engineer" or "to the Engineer", unless the context clearly indicates another meaning: contemplated, required, determined, directed, specified, authorized, ordered, given, designated, indicated, considered necessary, deemed necessary, permitted, reserved, suspended, established, approval, approved, disapproved, acceptable, unacceptable, suitable, accepted, satisfactory, unsatisfactory, sufficient, insufficient, rejected or condemned.
- 1.15_ CALENDAR DAY - Any day shown on the calendar beginning at midnight and ending at midnight the following day. If no designation of calendar or working day is made, "day" shall mean calendar day.
- 1.16_ CHANGE ORDER - A written order signed by the Engineer that establishes the full payment and final settlement of all claims for direct, indirect and consequential costs, including costs of delays, and establishes any adjustments to contract time related to the work covered and affected by one or more field orders, or for change work done or agreed to be done without issuance of a separate field order. A change order signed by all the parties to the contract constitutes a supplemental agreement.
- 1.17_ COMPLETION - See SUBSTANTIAL COMPLETION and FINAL COMPLETION.
- 1.18_ COMPTROLLER - The Comptroller of the State of Hawaii, Department of Accounting and General Services.

- 1.19_ CONSULTANT - A person, firm or corporation having a contract with the State to furnish services with respect to the project
- 1.20_ CONTRACT - The written agreement between the Contractor and the State of Hawaii by its Adjutant General, by which the Contractor is bound to furnish all labor, equipment, and materials and to perform the specified work within the contract time stipulated, and by which the State of Hawaii is obligated to compensate the Contractor therefore at the prices set forth therein. The contract shall include the Contract Documents and also any and all amendments and change orders which are required to complete the construction in an acceptable manner.
- 1.21_ CONTRACT COMPLETION DATE - The calendar day on which all work on the project, required by the contract, must be completed. See CONTRACT TIME and FINAL COMPLETION.
- 1.22_ CONTRACT DOCUMENTS - The Contract, Addenda (which pertain to the Contract Documents, Contractor's Proposal (including Wage Schedule, List of Subcontractors and other documentation accompanying the Bid and any post bid documentation submitted prior to the Notice of Award) when attached as an exhibit to the Contract, the Notice to Proceed, the Bonds, these GENERAL CONDITIONS, the SPECIAL CONDITIONS, the Specifications and the Drawings as the same are more specifically identified in the Contract together with all written Amendments, Change Orders, Field Orders, a written order for minor changes in the work and Engineer's written interpretations and clarifications issued on or after the effective date of the Contract.
- 1.23_ CONTRACT PRICE - The amount designated on the face of the contract for the performance of work including allowances for extra if any.
- 1.24_ CONTRACT TIME (or CONTRACT DURATION) - The number of calendar (or working) days provided for completion of the contract, inclusive of authorized time extensions. The number of days shall begin running on the effective date in the Notice to Proceed. If in lieu of providing a number of calendar (or working) days, the contract requires completion by a certain date, the work shall be completed by that date.
- 1.25_ CONTRACTOR - Any individual, partnership, firm, corporation, joint venture, or other legal entity undertaking the execution of the work under the terms of the contract with the State of Hawaii, and acting directly or through its agents, or employees.
- 1.26_ DEPARTMENT - The Department of Defense, State of Hawaii (abbreviated DOD).
- 1.27_ DRAWINGS (or Plans) - The contract drawings in graphic or pictorial form, which show the design, location, character, dimensions and details of the Work to be done and which shall be a part of the Contract Documents.
- 1.28_ ENGINEER - The Department of Defense Engineer, or the authorized person to act in the Engineer's behalf.
- 1.29_ EQUAL OR APPROVED EQUAL - Whenever this term is used in the drawings or specifications, it shall be interpreted to mean a brand or article, prequalified in accordance with Section 6.3 SUBSTITUTION OF MATERIALS AND EQUIPMENT, that may be used in place of the one specified.
- 1.30_ FIELD ORDER - A written order issued by the Engineer or the Engineer's authorized representative to the Contractor requiring the contract work to be performed in accordance with a change or changes in the work. A field order may (1) establish a price adjustment and/or time adjustment in an amount the Engineer believes is reasonable for the change; or (2) may declare that the Engineer does not intend to adjust contract time or price for the work; or (3) may request the Contractor to submit a proposal for an adjustment to the contract time and/or price by a certain date.
- 1.31_ FINAL COMPLETION - The date set by the Engineer that all work required by the contract and any amendments or changes thereto is in full compliance with the contract.
- 1.32_ FORCE ACCOUNT - Term used when Work is ordered to be done without prior agreements as to lump sum or unit price cost thereof and is to be billed for at cost of labor, materials and equipment, insurances, taxes, etc., plus an agreed percentage for overhead and profit.
- 1.33_ GUARANTEE - Legally enforceable assurance of the duration of satisfactory performance of quality of a product or Work
- 1.34_ GOODS - Materials. §103D-104

- 1.35_ HAZARDOUS MATERIALS - Any and all radioactive materials, asbestos, polychlorinated biphenyls, petroleum, crude oil, chemicals known to cause cancer or reproductive toxicity, pollutants, contaminants, toxic substances or materials cited in Hazardous Material Laws. Abandoned motor vehicles or parts thereof are not hazardous material.
- 1.36_ HOLIDAYS - The days of each year which are set apart and established as State holidays pursuant to Chapter 8, Hawaii Revised Statutes.
- 1.37_ INSPECTOR - The person assigned by the Engineer to make detailed inspections of contract performance and materials supplied for the work.
- 1.38_ LAWS - All Federal, State, City and County Laws, ordinances, rules and regulations, and standard specifications including any amendments thereto effective as of the date of the call for sealed bids.
- 1.39_ PERFORMANCE LIQUIDATED DAMAGES - The amount prescribed in the General Conditions, Section 7.26 FAILURE TO COMPLETE THE WORK ON TIME to be paid to the State or to be deducted from any payments due or to become due the Contractor for each working day or calendar day (as applicable) delay in completing the whole or any specified portion of the work beyond the Contract Time.
- 1.40_ LETTER OF AWARD - A written notice from the Engineer to the successful bidder(s) stating that its proposal has been accepted by the State.
- 1.41_ MAJOR UNIT PRICE ITEM - A unit price item which, when extended on its estimated quantities in the proposal form, exceeds five percent (5%) of the total base bid proposal less any allowance and contingent items included in the proposal.
- 1.42_ NON-CONFORMING WORK - Work that does not fulfill the requirements of the Contract Documents.
- 1.43_ NOTICE TO CONTRACTORS - See Solicitation.
- 1.44_ NOTICE TO PROCEED - A written notice from the Contracting Officer to the Contractor advising it of the date on which it is to begin the prosecution of the Work, which date shall also be the beginning of Contract Time.
- 1.45_ POST CONTRACT DRAWINGS - Drawings issued after the award of the contract for the purpose of clarification and / or changes to the work indicated in the original drawings and which may be made a part of the contract.
- 1.46_ PROJECT ACCEPTANCE DATE - The calendar day on which the Engineer accepts the project as sufficiently completed in compliance with the contract so that the State can occupy or utilize the Work for its intended use. See SUBSTANTIAL COMPLETION.
- 1.47_ PROJECT CONTRACT LIMITS (or Contract Zone) - The portion of the site as delineated on the drawings which define the Contractor's primary area of operation for the prosecution of the work. It does not define the exact limits of all construction that may be required under the contract.
- 1.48_ PROJECT GUARANTEE - A guarantee issued by the Contractor to the State. See GUARANTEE.
- 1.49_ PROPOSAL (Bid) - See Offer (or Bid).
- 1.50_ PROPOSAL FORM - See Offer Form (or Bid Form).
- 1.51_ PUNCH LIST - A list compiled by the Engineer (or Contractor) stating work yet to be completed or corrected by the Contractor in order to substantially complete or finally complete the contract requirements.
- 1.52_ QUESTIONNAIRE - The specified forms on which the bidder shall furnish required information as to its ability to perform and finance the work.
- 1.53_ SHOP DRAWINGS - All drawings, diagrams illustrations, schedules and other data or information which are specifically prepared or assembled by or for Contractor and submitted by Contractor to illustrate some portion of the Work.
- 1.54_ SPECIAL CONDITIONS - Supplements or modifies the standard clauses of the GENERAL CONDITIONS setting forth conditions or requirements peculiar to the individual project under consideration, which are not thoroughly or satisfactorily covered, described or explained in these GENERAL CONDITIONS.
- 1.55_ SPECIFICATIONS - That portion of the Contract Documents consisting of written descriptions for materials, equipment, construction systems, standards, workmanship, directions, provisions and requirements that

- pertain to the method and manner of performing the work and certain administrative requirements applicable thereto.
- 1.56_ STATE - The State of Hawaii acting through its authorized representative.
- 1.57_ SUBCONTRACT - Any written agreement between the Contractor and its subcontractors which contains the conditions under which the subcontractor is to perform a portion of the work for the Contractor.
- 1.58_ SUBCONTRACTOR - An individual, partnership, firm, corporation, joint venture or other legal entity, as covered in Chapter 444, Hawaii Revised Statutes, which enters into an agreement with the Contractor to perform a portion of the work for the Contractor.
- 1.59_ SUBSTANTIAL COMPLETION - The status of the project when the Contractor has completed all the work and 1) all utilities and services are connected and working, 2) all equipment is in acceptable working condition, 3) additional activity by the Contractor to correct punch list items as described herein will not prevent or disrupt use of the work or the facility in which the work is located, and 4) the building, structure, improvement or facility can be used for its intended purpose.
- 1.60_ SUPERINTENDENT - The employee of the Contractor who is charged with the responsibility of all the Work.
- 1.61_ SURETY - The qualified individual, firm or corporation other than the Contractor, which executes a bond with and for the Contractor to insure its acceptable performance of the contract.
- 1.62_ UNUSUALLY SEVERE WEATHER - Uncommonly harsh weather including but not limited to hurricanes, tornados, tropical storms and tropical depressions, or as otherwise defined in the SPECIAL CONDITIONS.
- 1.63_ WORK - The furnishing of all labor, materials, equipment, and other incidentals necessary or convenient for the successful completion of the project and the execution of all the duties and obligations imposed by the contract.
- 1.64_ WORKING DAY - A calendar day, exclusive of Saturdays, Sundays and State-recognized legal holidays for the month in question.
- 1.65_ OFFER (or Bid) – The executed document submitted by an Offeror in response to a solicitation request, to perform the work required by the proposed contract documents, for the price quoted and within the time allotted.
- 1.66_ OFFEROR (or BIDDER) – Any individual, partnership, firm, corporation, joint venture or other legal entity submitting directly or through a duly authorized representative or agent, an Offer for the work or construction contemplated.
- 1.67_ OFFER FORM (or BID FORM) – The form prepared by the Department on which the Offeror submits the written offer or bid. By submitting an offer or bid, the Offeror adopt the language on the form as its own.
- 1.68_ PROJECT START DATE – The date established in the Notice to Proceed when the Contractor shall begin prosecution of the work and the start of contract time.
- 1.69_ SOLICITATION – An Invitation to Bid or Request for Proposals or any other document issued by the Department to solicit bids or offers to perform a contract. The solicitation may indicate the time and place to receive the bids or offers and the location, nature and character of the work, construction or materials to be provided.

ABBREVIATIONS

HAR	Hawaii Administrative Rules
HRS	Hawaii Revised Statutes
VECP	Value Engineering cost Proposal
DOTAX	State Department of Taxation
IRS	Internal Revenue Service

BIDDING AND EXECUTION OF CONTRACT REQUIREMENTS

ARTICLE 2 - Proposal Requirements and Conditions

2.1 QUALIFICATION OF BIDDERS

Prospective bidders must be capable of performing the work for which bids are invited, and must be capable of entering into a public contract of \$25,000 or more.

2.1.1 Notice of Intention to Bid

2.1.1.1 In accordance with Section 103D-310, Hawaii Revised Statutes, and Section 3-122-111, Hawaii Administrative Rules, a written notice of intention to bid need not be filed for construction of any public building or public work. A written notice of intention to bid need not be filed for mere furnishing and installing of furniture, equipment, appliances, material and any combination of these items when a Contractor's license is not required under Chapter 444 of the Hawaii Revised Statutes, as amended, and the rules and regulations of the Contractor's License Board.

2.1.1.2 If two (2) or more prospective bidders desire to bid jointly as a joint venture on a single project, they must file an affidavit of joint venture. Such affidavit of joint venture will be valid only for the specific project for which it is filed. No further license is required when all parties to the joint venture possess current and appropriate contractor's licenses. Joint ventures are required to be licensed in accordance with Chapter 444 of the Hawaii Revised Statutes, as amended, and the rules and regulations of the Contractor's License Board when any party to the joint venture agreement does not hold a current or appropriate contractor's license. The joint venture must register with the office of the Director of Commerce and Consumer Affairs in accordance with Chapter 425 of the Hawaii Revised Statutes, as amended.

2.1.1.3 No persons, firm or corporation may bid where (1) the person, firm, or corporation, or (2) a corporation owned substantially by the person, firm, or corporation, or (3) a substantial stockholder or an officer of the corporation, or (4) a partner or substantial investor in the firm is in arrears in any payment owed to the State of Hawaii or any of its political subdivisions or is in default of any obligation to the State of Hawaii or to all or to any of its political subdivisions, including default as a surety or failure to perform faithfully and diligently any previous contract with the Department.

2.1.1.4 The Engineer may, in accordance with Section 103D-310 Hawaii Revised Statutes, require the prospective Bidder to submit answers to questions contained in the STANDARD QUALIFICATION QUESTIONNAIRE FOR PROSPECTIVE BIDDERS ON

PUBLIC WORKS CONTRACTS, on the form provided by the Department, properly executed and notarized, setting forth a complete statement of the experience of such prospective Bidder and its organization in performing similar work and a statement of the equipment proposed to be used, together with adequate proof of the availability of such equipment, at least two (2) working days prior to the time advertised for the opening of bids. If the information in the questionnaire proves satisfactory, the Bidder's proposal will be received. All information contained in the answers to the questionnaire shall be kept confidential. The questionnaire will be returned to the Bidder after it has served its purpose.

2.1.1.5 If upon review of the Questionnaire, or otherwise, the Bidder appears not fully qualified or able to perform the intended work, the Engineer shall, after affording the Bidder an opportunity to be heard and if still of the opinion that the Bidder is not fully qualified to perform the work, refuse to receive or to consider any bid offered by the prospective Bidder.

2.1.1.6 Failure to complete and submit the prequalification questionnaire by the designated deadline will be sufficient cause for the Department to disqualify a prospective Bidder.

2.1.2 Compliance Certificate § 103D -310(c) HRS)

2.1.2.1 Contractors are required to provide proof of compliance in order to receive a contract of \$25,000 or more. To meet this requirement, Offerors may apply and register at the "Hawaii Compliance Express" website: <http://vendors.hawaii.gov/hce/splash/welcome/html>

2.1.2.2 Tax clearances may be obtained by completing the Tax Clearance Application (Form A-6) and submitting it to the Hawaii State Department of Taxation (DOTAX) or the Internal Revenue Service (IRS). The application may be obtained from the DOTAX, or the IRS. The application may be mailed in or walked in to either the DOTAX or the IRS. Both tax agencies encourage the use of their mail-in process, which should be completed within twenty-one (21) calendar days. Tax clearance certificates will be issued to the applicant upon determination that the applicant has filed all tax returns due, and has paid all amounts owing on such returns, including penalty and interest.

2.1.2.3 Only original tax clearance certificates or certified copies will be accepted for this purpose. Failure to submit the required tax clearance certificates may be sufficient grounds for the Department to refuse to receive or consider the prospective bidder's proposal.

2.1.2.4 Tax clearance certificates are valid for six (6) months. The six-month period will begin with the later approval date stamped on the tax clearance. An original copy of a tax clearance that bears an original green

certified copy stamp will be accepted by the Department for final payment. The period of validity is two months.

2.1.2.5 The tax clearances submitted with the bid proposals must be valid on the solicitation's first legal advertisement date or any date thereafter up to the bid opening date. Valid tax clearances submitted with the proposal will remain valid for the contract award and encumbrance.

2.1.2.6 Any person, firm or corporation that is not presently doing business in the State of Hawaii and submits a Notice of Intention to Bid must submit along with said Notice of Intention to Bid a certified letter stating that said person, firm or corporation is not doing business in the State of Hawaii and is not in default of any obligations due to the State or any of its political subdivisions.

2.1.2.7 If a business cannot obtain a tax clearance certificate because of tax delinquencies, it may submit a "special letter" from DOTAX and/or the IRS. The "special letter" may only be obtained if (1) the business has an existing installment agreement with the tax agency, or (2) the delinquency is the subject of an administrative or judicial appeal. The bidder is cautioned that the "special letter" from the IRS must be certified by DOTAX. All conditions applied to tax clearance certificates for this purpose are applicable to these "special letters". Instructions to obtain the "special letter" are available from each respective tax agency.

2.1.2.8 Various combinations of tax clearance certificates and "special letters" are acceptable for this purpose as follows: Tax clearance certificate signed by both tax agencies;

- (a) Individual tax clearance certificates from each tax agency, respectively;
- (b) Tax clearance certificate from one tax agency and a "special letter" from the other tax agency;
- (c) "Special letters" from both tax agencies.

2.1.3 Wrongful Refusal to Accept a Bid - In the event the Engineer, for any reason, wrongfully refuses to accept what would otherwise be a responsive and responsible lowest bid, the exclusive remedy for such lowest bidder shall be the recovery of the reasonable actual costs of preparing the bid. No other bidder shall have any claim for damages. Refer to 2.13 PROTEST.

2.2 INTERPRETATION OF QUANTITIES IN BID SCHEDULE

2.2.1 When quantities for individual items of work are listed in the proposal form for which respective unit prices are asked, said quantities are estimated or approximate and are to be used by the Department only for the purpose of comparing on a uniform basis bids offered for the work. The Department does not, expressly or by implication, agree that the actual quantity of work will correspond therewith.

2.2.2 After determining the low bidder by comparison of bids submitted in accordance with the proposal form and Section 3.1 CONSIDERATION OF PROPOSALS; CANCELLATION in these specifications, the quantities of unit price items of work may increase or decrease.

2.2.3 On unit price bids, payment will be made only for the actual number of units incorporated into the finished project at the unit price bid, subject to Section 4.7 VARIATIONS IN ESTIMATED QUANTITIES.

2.3 CONTENTS OF PROPOSAL FORMS

2.3.1 Prospective bidders will be furnished with proposal forms giving the location, description, and the contract time of the work contemplated for which a lump sum bid price is asked or containing a schedule of items, together with estimated quantities of work to be performed and materials to be furnished, for which unit bid prices and/or lump sum bid prices are asked.

2.3.2 All papers bound with or attached to the proposal form shall be considered a part thereof and shall not be detached or altered when the proposal is submitted.

2.3.3 The drawings, specifications and other documents designated in the proposal form, will also be considered a part thereof whether attached or not.

2.3.4 By submitting a bid on the proposal form, a bidder accepts the language therein as its own.

2.4 THE SITE AND PROPOSED CONTRACT DOCUMENTS

2.4.1 The Bidder shall examine carefully the Project Site contemplated and the proposal, drawings, specifications, supplemental specifications, SPECIAL CONDITIONS, and any documents or items referenced therein and contract and bond forms therefore. The submission of a bid shall be considered as a warranty that the Bidder has made such examination and is informed of the conditions to be encountered in performing the Work and of the requirements of the drawings, specifications, supplemental specifications, SPECIAL CONDITIONS and any documents and items referenced therein, and contract and bonds.

2.5 ADDENDA AND BID CLARIFICATIONS

2.5.1 The terms and requirements of the bid documents (i.e. drawings, specifications and other bid and contract documents) cannot be changed prior to the bid opening except by a duly issued addenda or bid clarification.

2.5.2 The Department may alter, increase or decrease the scope of the work or the contract time, provisions and conditions by issuing a written addendum which sets forth such alterations, increase or decrease.

2.5.3 Bid Discrepancy - If a bidder discovers what it considers to be a discrepancy, ambiguity, omission or doubt as to the meaning of drawings, specifications and any other bid or contract documents, the bidder shall request in writing no later than 14 days before the bids are opened.

2.5.4 Addenda to the bid documents will be provided to all prospective bidders at the respective offices furnished for such purposes. Each addendum shall be an addition to the Contract Documents.

2.5.5 Upon providing an addenda, all bidders shall be deemed to be on notice of the information therein whether or not the addendum or bid clarification is actually received. All addenda and bid clarifications so issued shall become part of the Contract Documents.

2.5.6 No claim for additional compensation and/or time for performance will be allowed if the Contractor discovered, or in the exercise of reasonable care, should have discovered a discrepancy, ambiguity, omission or doubt for which an interpretation was not requested.

2.6 SUBSTITUTION OF MATERIALS AND EQUIPMENT BEFORE BID OPENING

2.6.1 Brand names of materials or equipment are specified or shown on the drawings to indicate a quality, style, appearance or performance and not to limit competition. The Bidder shall base its bid on one of the specified brand names unless alternate brands are qualified as equal or better in an addendum. Qualifications of such proposed alternate brands shall be submitted in writing and addressed to the Engineer. The face of the envelope containing the request must be clearly marked "SUBSTITUTION REQUEST". The request may be hand carried to the Department of Defense, State of Hawaii, 3949 Diamond Head Road, Honolulu, HI 96816-4495, or mailed. In either case, the written request must be received no later than the time and date specified in the NOTICE TO BIDDERS. The written request will be time stamped by the Department. For the purpose of this section, the time designated by the time stamping device in the Engineering Office shall be official. If the written request is hand carried, the bearer is

responsible to ensure that the request is time stamped by the Engineering Office.

2.6.2 Submit three (3) sets of the written request, technical brochures, and a statement of variances. Refer to the Appendix for the Sample "Request for Substitution."

2.6.3 Statement of Variances - The statement of variances must list all features of the proposed substitution which differ from the drawings, specifications and / or product(s) specified and must further certify that the substitution has no other variant features. The brochure and information submitted shall be clearly marked showing make, model, size, options, etc., and must include sufficient evidence to evaluate each feature listed as a variance. A request will be denied if submitted without sufficient evidence. If after installing the substituted product, an unlisted variance is discovered, Contractor shall immediately replace the product with a specified product all at no cost to the State

2.6.4 Substitution Denial - Any substitution request not complying with the above requirements will be denied. Substitution requests sent to other agencies and received by the Engineering Office after the deadline above will be denied.

2.6.5 An addendum shall be issued to inform all prospective bidders of any accepted substitution in accordance with Section 2.5 ADDENDA AND BID CLARIFICATIONS.

2.6.6 For substitutions of materials and equipment after issuance of the Letter of Award, refer to Section 6.3 SUBSTITUTION OF MATERIALS AND EQUIPMENT AFTER BID OPENING.

2.7 PREPARATION OF PROPOSAL

2.7.1 The Bidder's proposal must be submitted on the proposal form furnished by the Department. The proposal must be prepared in full accordance with the instructions thereon. The Bidder must state, both in words and numerals, the lump sum price or total sum bid at which the work contemplated is proposed to be done. These prices must be written in ink or typed. In case of a discrepancy between the prices written in words and those written in figures, the words shall govern over the figures. The Bidder shall sign the proposal in the spaces provided with ink. By submitting a bid, the Bidder adopts the language of the proposal as its own.

2.7.2 If the proposal is made by an individual, the person's name and post office address must be shown in the space provided. If made by a partnership the name and post office address of each member of the partnership must be shown and the proposal signed by all partners or evidence in the form of a partnership agreement must be

submitted showing the authority of the partner to enter, on behalf of said partnership, into contract with the State. If made by a corporation the proposal must show the name, titles, and business address of the president, secretary and treasurer and also evidence in the form of a corporate resolution must be submitted showing the authority of the particular corporate representative to enter on behalf of said corporation into contract with the State. If made by a joint venture the name and post office address of each member of the individual firm, partnership or corporation comprising the joint-venture must be shown with other pertinent information required of individuals, partnerships or corporations as the case may be. The proposal must be signed by all parties to the joint-venture or evidence in the form of a Joint-Venture Agreement must be submitted showing the authority of the joint-venture's representative to enter on behalf of said joint-venture into contract with the State.

2.7.3 Pursuant to the requirements of Section 103D-302, HRS, each Bidder shall include in its bid the name of each person or firm to be engaged by the Bidder on the project as joint contractor or subcontractor indicating also the nature and scope of work to be performed by such joint contractor and/or subcontractor and their respective contractor's license number. If the Bidder fails to list a joint contractor or subcontractor, the State may accept the bid if it is in the State's best interest and the value of the work to be performed by the joint contractor or subcontractor is equal to or less than one percent of the total bid amount. The Bidder shall be solely responsible for verifying that their joint contractor or subcontractor has the proper license at the time of the submitted bid.

2.8 BID SECURITY §3-122-223(d) HAR

2.8.1 Subject to the exceptions in Section 3-122-223(d) HAR, all lump sum bids of \$25,000 and higher, or lump sum base bids including alternates of \$25,000 and higher, that are not accompanied by bid security are non-responsive. Bid security shall be one of the following: §3-122-222(a) HAR

2.8.1.1 Surety bid bond underwritten by a company licensed to issue bonds in this State which shall be substantially in the form of the Surety Bid Bond form in the Appendix; or

2.8.1.2 Legal Tender; or

2.8.1.3 Certificate of Deposit; Credit Union share certificate; or cashier's, treasurer's, teller's or official check drawn by, or a certified check accepted by, and payable on demand to the State by a bank, a savings institution, or credit union insured by the Federal Deposit Insurance Corporation or the National Credit Union Administration.

- (a) These instruments may be utilized only to a maximum of \$100,000.
- (b) If the required security or bond amount totals over \$100,000, more than one instrument not exceeding \$100,000 each and issued by different financial institutions shall be accepted.
- (c) **CAUTION** - Bidders are cautioned that certificates of deposit or share certificates with an early withdrawal penalty must have a face value sufficient to cover the maximum penalty amount in addition to the proposal guaranty requirement. If the certificate is made out to two names, the certificate must be assigned unconditionally to the Department of Defense.

2.8.2 Unless otherwise stated, the bid security shall be in an amount equal to at least five percent (5%) of the lump sum bid or lump sum base bid including alternates or in an amount required by the terms of the federal funding, where applicable.

2.8.3 If the Bidder is a corporation, evidence in the form of a corporate resolution, authorizing the corporate representative to execute the bond must be submitted with the proposal. (See sample in Appendix.) If the Bidder is a partnership, all partners must sign the bond or evidence in the form of a partnership agreement must be submitted showing the authority of the partner.

2.8.4 If the Bidder is a joint -venture, all parties to the joint venture must sign the bond; provided, that one party to the joint-venture may sign on behalf of the joint-venture if evidence in the form of a joint-venture agreement or power of attorney, is submitted showing the authority of the signatory to sign the bond on behalf of the joint-venture.

2.8.5 In the case where the award will be made on a group or item basis, the amount of bid security shall be based on the total bid for all groups or items submitted.

2.8.6 Bidders are cautioned that surety bid bonds which place a limit in value to the difference between the bid amount and the next acceptable bid, such value not to exceed the purported amount of the bond, are not acceptable. Also, surety bid bonds which place a time limit on the right of the State to make claim other than allowed by statutes or these GENERAL CONDITIONS are not acceptable. Bidders are hereby notified that a surety bid bond containing such limitation(s) is not acceptable and a bid accompanied by such surety bid bond will be automatically rejected.

2.9 DELIVERY OF PROPOSALS - The entire proposal shall be placed together with the bid security, in a sealed envelope so marked as to indicate the identity of the project, the project number, the date of bid opening

and the name and address of the bidder and then delivered as indicated in the Notice to Contractors. Bids which do not comply with this requirement may not be considered. Proposals will be received up to the time fixed in the public notice for opening of bids and must be in the hands of the official by the time indicated. The words "SEALED BID" must be clearly written or typed on the face of the sealed envelope containing the proposal and bid security.

2.10 WITHDRAWAL OR REVISION OF PROPOSAL - may be modified prior to the deadline to submit the offers by any of the following documents.

2.10.1 Withdrawal of Proposals:

2.10.1.1 A signed, written notice received in the office designated in the solicitation; or

2.10.1.2 A written notice faxed to the office designated in the solicitation; or

2.10.1.3 A telegraphic message received by telephone by the office designated in the solicitation from the receiving telegraph company office, provided the telegraph company confirms the telephone message by sending a written copy of the telegram showing that the message was received at such office prior to the time and date set for the opening.

2.10.2 Modification of Proposals:

2.10.2.1 A written notice received in the office designated in the solicitation, stating that a modification to the offer is submitted; and

2.10.2.2 The actual modification sealed securely in a separate envelope or container, accompanying the written notice.

2.11 PUBLIC OPENING OF PROPOSALS - Proposals will be opened and read publicly at the time and place indicated in the Notice to Contractors. Bidders, their authorized agents and other interested parties are invited to be present.

2.12 DISQUALIFICATION OF BIDDERS - Any one or more of the following causes will be considered as sufficient for the disqualification of a Bidder and the rejection of its proposal or proposals:

2.12.1 Non-compliance with Section 2.1 QUALIFICATION OF BIDDERS.

2.12.2 Evidence of collusion among bidders.

2.12.3 Lack of responsibility and cooperation as shown by past work such as failing to complete all of the requirements to close the project within a reasonable time

or engaging in a pattern of unreasonable or frivolous claims for extra compensation.

2.12.4 Being in arrears on existing contracts with the State of Hawaii, or having defaulted on a previous contract with the State of Hawaii.

2.12.5 Lack of proper equipment and/or sufficient experience to perform the work contemplated, as revealed by the Standard Questionnaire and Financial Statement for Bidders.

2.12.6 No contractor's license or a contractor's license which does not cover type of work contemplated.

2.12.7 More than one proposal for the same work from an individual, firm, partnership, corporation or joint venture under the same or different name.

2.12.8 Delivery of bids after the deadline specified in the advertisement calling for bids.

2.12.9 Failure to pay, or satisfactorily settle, all bills overdue for labor and materials of former contracts in force at the time of issuance of proposal forms.

2.12.10 Debarment or suspension pursuant to the provisions of Chapters 103D, 104 and 444, Hawaii Revised Statutes, as amended.

2.13 PROTEST

2.13.1 Protests shall be adjudicated in accordance with §103D-701, HRS and as amended.

2.13.2 No Protest based upon the contents of the solicitation shall be considered unless it is submitted in writing to the Engineer, prior to the date set for the receipt of proposals.

2.13.3 A protest of an award or proposed award pursuant to §103D-302 or §103D-303, HRS, shall be submitted in writing to the Engineer within five (5) working days after the posting of the award of the Contract.

2.13.4 In addition to any other relief, when a protest is sustained and the protestor should have been awarded the contract under the solicitation but is not, then the protestor shall be entitled to the actual costs reasonably incurred in connection with the solicitation, including bid or proposal preparation costs but not attorney's fees.

ARTICLE 3 - Award and Execution of Contract

3.1 CONSIDERATION OF PROPOSALS; CANCELLATION - After the proposals are opened and read, the figures will be extended and/or totaled in accordance with the bid prices of the acceptable proposals and the totals will be compared and the results of such

comparison shall be made public. In the event of a tie bid, the low bidder shall be determined by lot. In the comparison of bids, words written in the proposals will govern over figures and unit prices will govern over totals. Until the award of the contract, the Department may cancel the solicitation, reject any and all proposals in whole or part and may waive any defects or technicalities whenever such action is deemed to be in the best interest of the State.

3.2 IRREGULAR PROPOSALS - Proposals will be considered irregular and may be rejected for the following reasons:

3.2.1 If the proposal is unsigned.

3.2.2 If bid security is not in accordance with Section 2.8 BID SECURITY.

3.2.3 If proposal is on a form other than that furnished by the Department; or if the form is altered or any part thereof detached.

3.2.4 If the proposal shows any non-compliance with applicable law, alteration of form, additions not called, conditional bids, incomplete bids, non initialed erasures, other defects, or if the prices are obviously unbalanced.

3.2.5 If the Bidder adds any provisions reserving the right to accept or reject an award.

3.2.6 If the Bidder adds any provisions reserving the right to enter into a contract pursuant to an award.

3.2.7 When a proposal is signed by an officer or officers of a corporation and a currently certified corporate resolution authorizing such signer(s) to submit such proposal is not submitted with the proposal or when the proposal is signed by an agent other than the officer or officers of a corporation or a member of a partnership and a power of attorney is not submitted with the proposal.

3.2.8 Where there is an incomplete or ambiguous listing of joint contractors and/or subcontractors the proposal may be rejected. All work which is not listed as being performed by joint contractors and/or subcontractors must be performed by the bidder with its own employees. Additions to the list of joint contractors or subcontractors will not be allowed. Whenever there is a doubt as to the completeness of the list, the Bidder will be required to submit within five (5) working days, a written confirmation that the work in question will be performed with its own work force. Whenever there is more than one joint contractor and/or subcontractor listed for the same item of work, the Bidder will be required to either confirm in writing within five (5) working days that all joint contractors or subcontractors listed will actually be engaged on the project or obtain within five (5)

working days written releases from those joint contractors and/or subcontractors who will not be engaged.

3.2.9 If in the opinion of the Engineer, the Bidder and its listed subcontractors do not have the contractor's licenses or combination of contractor's licenses necessary to complete all of the work.

3.3 CORRECTION OF BIDS AND WITHDRAWAL OF BIDS §3-122-31 HAR

3.3.1 Corrections to bids after bid openings but prior to award may be made under the following conditions:

3.3.1.1 If the mistake is attributable to an arithmetical error, the Engineer shall so correct the mistake. In case of error in extension of bid price, the unit price shall govern.

3.3.1.2 If the mistake is a minor informality which shall not affect price, quantity, quality, delivery, or contractual conditions, the Bidder shall request correction by submitting proof of evidentiary value which demonstrates that a mistake was made. The Engineer shall prepare a written approval or denial in response to this request. Examples of such mistakes include:

(a) Typographical errors;

(b) Transposition errors;

(c) Failure of a Bidder to sign the bid, but only if the unsigned bid is accompanied by other material indicating the Bidder's intent to be bound.

3.3.1.3 For reasons not allowable under paragraphs 3.3.1.1 and 3.3.1.2 when the Engineer determines that the correction or waiver of an obvious mistake is in the best interest of the Department or is warranted for the fair treatment of other bidders.

3.3.2 Withdrawal of bids after bid opening but prior to award may be made when the bid contains a mistake attributable to an obvious error which affects price, quantity, quality, delivery, or contractual conditions, and the bidder requests withdrawal by submitting proof of evidentiary value which demonstrates that a mistake was made. The Contracting Officer shall prepare a written approval or denial in response to this request.

3.3.3 Correction or withdrawal of bids after award is not permissible except in response to a written withdrawal or correction request by the Contractor, and the Engineer makes a written determination that the Department's procurement practices and policies would not be materially affected by such correction or withdrawal.

3.4 AWARD OF CONTRACT

3.4.1 The award of contract, if it be awarded, will be made within ninety (90) consecutive calendar days after the opening of the proposals to the lowest responsible and responsive Bidder (including the alternate or alternates which may be selected by the Engineer in the case of alternate bids) whose proposal complies with all the requirements prescribed, but in no case will an award be made until all necessary investigations are made. The successful Bidder will be notified, by letter mailed to the address shown on the proposal, that its bid has been accepted and that it has been awarded the contract.

3.4.2 If the contract is not awarded within the ninety (90) days noted in paragraph 3.4.1 above, the Department may request the successful Bidder to extend the time for the acceptance of its bid. The Bidder may reject such a request without penalty; and in such case, the Department may at its sole discretion make a similar offer to the next lowest responsive and responsible bidder and so on until a bid is duly accepted or until the Department elects to stop making such requests.

3.4.3 No contract will be awarded to any person or firm suspended or debarred under the provisions of Chapters 103D, 104 and Chapter 444, Hawaii Revised Statutes as amended.

3.4.4 The contract will be drawn on the forms furnished by the Comptroller. The contract will not be binding upon the Department until all required signatures have been affixed thereto and written certification that funds are available for the work has been made.

3.5 CANCELLATION OF AWARD - The Department reserves the right to cancel the award of any contract at any time before the execution of said contract by all parties. The exclusive remedy to the awardee for such cancellation shall be payment of the reasonable bid preparation costs and the reimbursement of any direct expenses incurred as directed in the Notice of Award. Such cancellation will not incur any liability by the Department to any other Bidder.

3.6 RETURN OF BID SECURITY - All bid securities, except those of the four (4) lowest Bidders, will be returned following the opening and checking of the proposals. The retained bid securities of the four lowest Bidders will be returned within five (5) working days following the complete execution of the contract.

3.7 REQUIREMENT OF PERFORMANCE AND PAYMENT BONDS

3.7.1 Performance and Payment Bonds shall be required for contracts \$25,000 and higher. At the time of the execution of the contract, the successful Bidder shall file good and sufficient performance and payment bonds on the form furnished by the Department (see Appendix), each in an amount equal to one hundred percent (100%)

of the amount of the contract price unless otherwise stated in the solicitation of bids. Acceptable performance and payment bonds shall be limited to the following:

3.7.1.2 Surety bonds underwritten by a company licensed to issue bonds in this State; or

3.7.1.3 A certificate of deposit; credit union share certificate; or cashier's, treasurer's, teller's or official check drawn by, or a certified check accepted by, and payable on demand to the State by a bank, a savings institution, or credit union insured by the Federal Deposit Insurance Corporation or the National Credit Union Administration.

(a) These instruments may be utilized only a maximum of \$100,000.

(b) If the required security or bond amount totals over \$100,000, more than one instrument not exceeding \$100,000 each and issued by different financial institutions shall be acceptable.

3.7.2 If the Contractor fails to deliver the required performance and payment bonds, the contractor's award shall be canceled, the Department shall have the remedies provided under Section 3.9 FAILURE TO EXECUTE THE CONTRACT and award of the contract shall be made to the next lowest responsible and responsive bidder.

3.8 CAMPAIGN CONTRIBUTIONS BY STATE AND COUNTY CONTRACTORS

Contractors are hereby notified of the applicability of Section 11-205.5, HRS, which states that campaign contributions are prohibited from specified State or County government contractors during the term of the contract if the contractors are paid with funds appropriated by a legislative body.

3.9 EXECUTION OF THE CONTRACT

3.9.1 Upon acceptance of the successful bidder's offer by the Contracting Officer, the Contractor shall provide satisfactory performance and payments bonds within ten (10) calendar days after the award of the contract or within such further time as granted by the Contracting Officer. No proposal or contract shall be considered binding upon the State until the contract has been fully and properly executed by all parties thereto and the Comptroller has endorsed thereon its certificate, as required by Section 103D-309, HRS, that there is an available unexpended appropriation or balance of an appropriation over and above all outstanding contracts sufficient to cover the State's amount required by such contract.

3.9.2 On any individual award totaling less than \$25,000, the State reserves the right to execute the

contract by the issuance of a State Purchase Order. Issuance of a State Purchase Order shall result in a binding contract between the parties without further action by the State. The issuance of a Purchase Order shall not be deemed a waiver of these General Conditions and Contract Document requirements.

3.10 FAILURE TO EXECUTE THE CONTRACT

3.10.1 Before the Award - If a low Bidder without legal justification withdraws its bid after the opening of bids but before the award of the contract, the State shall be entitled to retain as liquidated damages the amount established as bid security, and may take all appropriate actions to recover the performance liquidated damages sum from the property or third-party obligations deposited as bid security.

3.10.2 After the Award - If the Bidder to whom a contract is awarded shall fail or neglect to furnish security within ten (10) calendar days after such award or within such further time as the Contracting Officer may allow, the State shall be entitled to recover from such Bidder its actual damages, including but not limited to the difference between the bid and the next lowest responsive bid, as well as personnel and administrative costs, consulting and legal fees and other expenses incurred in arranging a contract with the next low responsive bidder or calling for new bids. The State may apply all or part of the amount of the bid security to reduce its damages. If upon determination by the State of the amount of its damages the bid security exceeds that amount, it shall release or return the excess to the person who provided same.

3.10.3 Engineer's Options - Upon a withdrawal of the lowest responsive bid, or upon a refusal or failure of the lowest Bidder to execute the contract, the Engineer may thereupon award the contract to the next lowest responsible and responsive Bidder or may call for new bids, whichever method the Engineer may deem to be in the best interests of the State.

3.11 NOTICE TO PROCEED

3.11.1 After the contract is fully executed and signed by the Department of Defense, the Contractor will be sent a formal Notice to Proceed letter advising the Contractor of the date on which it may proceed with the work. The Contractor shall be allowed ten (10) consecutive working days from said date to begin its work. In the event that the Contractor refuses or neglects to start the work, the Engineer may terminate the contract in accordance with Section 7.27 TERMINATION OF CONTRACT FOR CAUSE.

3.11.2 The Contractor may commence its operations strictly at its own risk prior to receipt of the formal notice to proceed, provided it makes a written request and has

received approval from the Engineer in writing. All work performed shall be conducted in accordance with Section 7.1 PROSECUTION OF THE WORK.

3.11.3 In certain cases, the State, with agreement of the Contractor, may issue a Notice to Proceed before full execution of the contract by the Engineer and it may further issue a Notice to Proceed concurrently with the Notice of Award.

3.11.4 In the event the Notice to Proceed is not issued within one hundred and eighty (180) days after the date of the award of contract the Contractor may submit a claim for increased labor and material costs (but not overhead costs) which are directly attributable to the delay beyond the first 180 days. Such claims shall be accompanied with the necessary documentation to justify the claim. No payment will be made for escalation costs that are not fully justified.

GENERAL CONDITIONS ARTICLE 4 - Scope of Work

4.1 INTENT OF CONTRACT, DUTY OF CONTRACTOR - The intent of the Contract is to provide for the construction, complete in every detail, of the Work described at the accepted bid price and within the time established by the contract. The Contractor has the duty to furnish all labor, materials, equipment, tools, transportation, incidentals and supplies and to determine the means, methods and schedules required to complete the work in accordance with the drawings, specifications and terms of the contract.

4.2 CHANGES - The Engineer may at any time, during the progress of the work, by written order, and without notice to the sureties, make changes in the work as may be found to be necessary or desirable. Such changes shall not invalidate the Contract nor release the Surety, and the Contractor will perform the work as changed, as though it had been a part of the original Contract.

4.2.1 Minor Changes - Minor changes in the work may be directed by the Engineer with no change in contract price or time of performance. Minor changes are consistent with the intent of the Contract Documents and do not substantially alter the type of work to be performed or involve any adjustment to the contract sum or extension of the contract time.

4.2.2 Oral Orders

4.2.2.1 Any oral order, direction, instruction, interpretation or determination from the Engineer or any other person which in the opinion of the Contractor causes any change, shall be considered as a change only if the Contractor gives the Engineer written notice of its intent to treat such oral order, direction, instruction,

interpretation or determination as a change directive. Such written notice must be delivered to the Engineer before the Contractor acts in conformity with the oral order, direction, instruction, interpretation or determination, but not more than five (5) days after delivery of the oral order to the Contractor. The written notice shall state the date, circumstances, whether a time extension will be requested, and source of the order that the Contractor regards as a change. Such written notice may not be waived and shall be a condition precedent to the filing of any claim by the Contractor. Unless the Contractor acts in accordance with this procedure, any such oral order shall not be treated as a change for which the Contractor may make a claim for an increase in the contract time or contract price related to such work.

4.2.2.2 No more than five (5) days after receipt of the written notice from the Contractor, a Field Order shall be issued for the subject work if the State agrees that it constitutes a change. If no Field Order is issued in the time established, it shall be deemed a rejection of Contractor's claim for a change. If the Contractor objects to the failure to issue a Field Order, it shall file a written protest with the Engineer within thirty (30) days after delivery to the Engineer of the Contractor's written notice of its intention to treat the oral order as a change. In all cases, the Contractor shall proceed with the work. The protest shall be determined as provided in Section 7.25 DISPUTES AND CLAIMS.

4.2.3 Field Orders – Upon receipt of a Field Order, the Contractor shall proceed with the changes as ordered. If the Contractor does not agree with any of the terms or conditions or in the adjustment or non-adjustment to the contract time and / or contract price, Contractor shall file a notice of intent to claim within thirty (30) calendar days after receipt of the written Field Order that was not agreed upon by both parties. Failure to file such protest within the time specified shall constitute agreement on the part of the Contractor with the terms, conditions, amounts and adjustment or non-adjustment to contract price and / or contract time set forth in the Field Order. The requirement for timely written notice shall be a condition precedent to the assertion of a claim.

4.2.4 Change Orders

4.2.4.1 The Department will issue sequentially numbered Change Orders at times it deems appropriate during the contract period. A Change Order may contain the adjustment in contract price and / or time for a number of Field Orders. The Change Order will be issued in the format attached (refer to the Appendix). No payment for any change will be made until the change order is issued.

4.2.4.2 The penal sum of the Surety Performance and Payment Bonds will be adjusted by the amount of each and every Change Order.

4.2.4.3 Upon receipt of a change order, that the Contractor does not agree with any of the terms or conditions or the adjustments or non adjustments of the contract price or contract time; the Contractor shall not execute or sign the change order, but shall return the unsigned change order, along with a written notification of the conditions or items that are in dispute.

4.2.4.4 If the Contractor signs or executes the change order, this constitutes an agreement on the part of the Contractor with the terms and conditions of the change order. A change order that is mutually agreed to and signed by the parties of the contract constitutes a contract modification.

4.2.5 Claim Notification – The Contractor shall file a notice of intent to claim for a disputed change order within 30 calendar days after receipt of the written order. Failure to file the protest within the time specified constitutes an agreement on the part of the Contractor within the terms, conditions, amounts and adjustment or non-adjustment to contract price or contract time set forth in the dispute change order. The requirement for timely written notice shall be a condition precedent to the assertion of a claim.

4.2.6 Proceeding with Directed Work – Upon receipt of a contract modification, change order, or field order, the Contractor shall proceed with the directed changes and instructions. The Contractor's right to make a claim for additional compensation or an extension of time for completion is not affected by proceeding with the changes and instructions described in a change order and field order.

4.2.7 Pricing or Negotiating Costs Not Allowed – The Contractor's cost of responding to requests for price or time adjustments is included in the contract price. No additional compensation will be allowed unless authorized by the Contracting Officer.

4.3 DUTY OF CONTRACTOR TO PROVIDE PROPOSAL FOR CHANGES

4.3.1 A Field Order may request the Contractor to supply the Department with a proposal for an adjustment to the contract time or contract price for the work described therein. Any such request for a proposal shall not affect the duty of the Contractor to proceed as ordered with the work described in the Field Order.

4.3.2 The Engineer from time to time may issue a Bulletin to the Contractor requesting price and / or time adjustment proposals for contemplated changes in the work. A Bulletin is not a directive for the Contractor to perform the work described therein.

4.3.3 Within fifteen (15) days after receipt of a Bulletin or Field Order containing a request for proposal,

the Contractor shall submit to the Engineer a detailed written statement in a format similar to the one shown in the Appendix to these General Conditions setting forth all charges the Contractor proposes for the change and the proposed adjustment of the contract time, all properly itemized and supported by sufficient substantiating data to permit evaluation. No time extension will be granted for delays caused by late Contractor pricing of changes or proposed changes. If the project is delayed because Contractor failed to submit the cost proposal within the fifteen (15) days, or as allowed by the Engineer, performance liquidated damages will be assessed in accordance with Section 7.26 FAILURE TO COMPLETE THE WORK ON TIME.

4.3.4 No payment shall be allowed to the Contractor for pricing or negotiating proposed or actual changes.

4.4 PRICE ADJUSTMENT HRS 103D-501

4.4.1 A fully executed change order or other document permitting billing for the adjustment in price under any method listed in paragraphs (4.4.1.1) through (4.4.1.5) shall be issued within ten days after agreement on the price adjustment. Any adjustment in the contract price pursuant to a change or claim in this contract shall be made in one or more of the following ways:

4.4.1.1 By agreement on a fixed price adjustment before commencement of the pertinent performance;

4.4.1.2 By unit prices specified in the contract or subsequently agreed upon before commencement of the pertinent performance;

4.4.1.3 Whenever there is a variation in quantity for any work covered by any line item in the schedule of costs submitted as required by Section 7.2 COMMENCEMENT REQUIREMENTS, by the Department at its discretion, adjusting the lump sum price proportionately;

4.4.1.4 Force Account Method. At the sole option of the Contracting Officer, by the costs attributable to the event or situation covered by the change, plus appropriate profit or fee, all as specified in Section 4.5 ALLOWANCES FOR OVERHEAD AND PROFIT and the force account provision of Section 8.3 PAYMENT FOR ADDITIONAL WORK before commencement of the pertinent performance;

4.4.1.5 In such other manner as the parties may mutually agree upon before commencement of the pertinent performance; or

4.4.1.6 In the absence of an agreement between the two parties:

4.4.1.6.a For change orders with value not exceeding \$50,000 by documented actual costs of the work,

allowing for overhead and profit as set forth in Section 4.5 ALLOWANCES FOR OVERHEAD AND PROFIT. A change order shall be issued within fifteen days of submission by the contractor of proper documentation of completed force account work, whether periodic (conforming to the applicable billing cycle) or final. The procurement officer shall return any documentation that is defective to the contractor within fifteen days after receipt, with a statement identifying the defect; or

4.4.1.6.b For change orders with value exceeding \$50,000 by a unilateral determination by the Contracting Officer of the reasonable and necessary costs attributable to the event or situation covered by the change, plus appropriate profit or fee, all as computed by the Contracting Officer in accordance with applicable sections of Chapters 3-123 and 3-126 of the Hawaii Administrative Rules, and Section 4.5 ALLOWANCES FOR OVERHEAD AND PROFIT. When a unilateral determination has been made, a unilateral change order shall be issued within ten days. Upon receipt of the unilateral change order, if the contractor does not agree with any of the terms or conditions, or the adjustment of non-adjustment of the contract time or contract price, the contractor shall file a notice if intent to claim within thirty days after the receipt of the written unilateral change order. Failure to file a protest within the time specified shall constitute agreement on the part of the contractor with the terms, conditions, amounts, and adjustment or non-adjustment of the contract time or the contract price set forth in the unilateral change order.

4.4.1.7 In such other manner as the parties may mutually agree;

4.4.1.8 At the sole option of the Engineer, by the costs attributable to the event or situation covered by the change, plus appropriate profit or fee, all as specified in Section 4.5 ALLOWANCES FOR OVERHEAD AND PROFIT and the force account provision of Section 8.3 PAYMENT FOR ADDITIONAL WORK; or

4.4.1.9 In the absence of an agreement between the two parties, by a unilateral determination by the Engineer of the reasonable and necessary costs attributable to the event or situation covered by the change, plus appropriate profit or fee, all as computed by the Engineer in accordance with applicable sections of Chapters 3-123 and 3-126 of the Hawaii Administrative Rules and Regulations, and Section 4.5 ALLOWANCES FOR OVERHEAD AND PROFIT.

4.4.2 Cost or Pricing Data – Contractor shall provide and certify cost or pricing data for any price adjustment to a contract involving aggregate increases and decreases in costs plus applicable profits expected to exceed \$100,000. The certified cost or pricing data shall be subject to the provisions of HAR chapter 3-122, subchapter 15.

4.5 ALLOWANCES FOR OVERHEAD AND PROFIT HRS103D-501

4.5.1 In determining the cost or credit to the Department resulting from a change, the allowances for all overhead, including, extended overhead resulting from adjustments to contract time (including home office, branch office and field overhead, and related delay impact costs) and profit combined, shall not exceed the percentages set forth below:

4.5.1.1 For the Contractor, for any work performed by its own labor forces, twenty percent (20%) of the direct cost;

4.5.1.2 For each subcontractor involved, for any work performed by its own forces, twenty percent (20%) of the direct cost;

4.5.1.3 For the Contractor or any subcontractor, for work performed by their subcontractors, ten percent (10%) of the amount due the performing subcontractor.

4.5.2 Not more than three markup allowance line item additions not exceeding the maximum percentage shown above will be allowed for profit and overhead, regardless of the number of tier subcontractors.

4.5.3 The allowance percentages will be applied to all credits and to the net increase of direct costs where work is added and deleted by the changes.

4.6 PAYMENT FOR DELETED MATERIAL

4.6.1 Cancelled Orders - If acceptable material was ordered by the Contractor for any item deleted by an ordered change in the work prior to the date of notification of such deletion by the Engineer, the Contractor shall use its best efforts to cancel the order. The Department shall pay reasonable cancellation charges required by the supplier excluding any markup for overhead and profit to the Contractor.

4.6.2 Returned Materials - If acceptable deleted material is in the possession of the Contractor or is ultimately received by the Contractor, if such material is returnable to the supplier and the Engineer so directs, the material shall be returned and the Contractor will be paid for the reasonable charges made by the supplier for the return of the material, excluding any markup for overhead and profit to the Contractor. The cost to the Contractor for handling the returned material will be paid for as provided in Section 4.4 PRICE ADJUSTMENT.

4.6.3 Uncancelled Materials - If orders for acceptable deleted material cannot be canceled at a reasonable cost, it will be paid for at the actual cost to the Contractor including an appropriate markup for overhead and profit as set forth in Section 4.5 ALLOWANCES FOR

OVERHEAD AND PROFIT. In such case, the material paid for shall become the property of the State and the cost of further storage and handling shall be paid for as provided in Section 4.4 PRICE ADJUSTMENT.

4.7 VARIATIONS IN ESTIMATED QUANTITIES §3-125-10 HAR

4.7.1 Where the quantity of a major unit price item in this contract is estimated on the proposal form and where the actual quantity of such pay item varies more than fifteen percent (15%) above or below the estimated quantity stated in this contract, an adjustment in the contract price shall be made upon demand of either party. The adjustment shall be based upon any increase or decrease in costs due solely to the variation above one hundred fifteen percent (115%) or below eighty-five percent (85%) of the estimated quantity. The adjustment shall be subject to Section 4.4 PRICE ADJUSTMENT and Section 4.5 ALLOWANCES FOR OVERHEAD AND PROFIT. If the quantity variation is such as to cause an increase in the time necessary for completion, the Engineer shall, upon receipt of a written request for an extension of time within thirty (30) days of the item's completion, ascertain the facts and make such adjustment to the completion date as the Engineer finds justified.

4.8 VARIATIONS IN BOTTOM ELEVATIONS

The Contractor shall plan and construct to the bottom elevations of footings, piles, drilled shafts, or cofferdams as shown on the drawings. When the bottom of a pile, drilled shaft, or cofferdam is shown as an estimated or approximate elevation, the Contractor shall plan and construct to that elevation or to any deeper elevation required by the drawings or direction of the Engineer. In the event the bottom elevation is lowered, the Contractor shall be entitled to additional payment in accordance with Sections 4.4 PRICE ADJUSTMENT and 4.5 ALLOWANCES FOR OVERHEAD AND PROFIT. In the event the bottom elevation is raised, the State shall be entitled to a credit in accordance with Sections 4.2 CHANGES, 4.4 PRICE ADJUSTMENT and 4.5 ALLOWANCES FOR OVERHEAD AND PROFIT.

4.9 DIFFERING SITE CONDITIONS §3-125-11 HAR

4.9.1 During the progress of the work, if the Contractor encounters conditions at the site differing materially from those shown in the drawings and specifications, Contractor shall promptly, and before any such conditions are disturbed or damaged (except in an emergency as required by subsection 7.17.8), notify the Engineer in writing of:

4.9.1.1 Subsurface or latent physical conditions at the site differing materially from those indicated in the contract; or

4.9.1.2 Unknown physical conditions at the site, of an unusual nature differing materially from those ordinarily encountered and generally recognized as inherent in work of the character provided for in this contract.

4.9.2 After receipt of written notice, the Engineer shall promptly investigate the site, and if it is found that such conditions do materially differ and cause an increase in the Contractor's cost of, or the time required to, perform any part of the Work, whether or not changed as a result of such conditions, an adjustment shall be made and the contract modified accordingly. Any adjustment in contract price made pursuant to this Section 4.9 shall be determined in accordance with Sections 4.4 PRICE ADJUSTMENT and 7.25 DISPUTES AND CLAIMS.

4.9.3 Nothing contained in this Section 4.9 shall be grounds for an adjustment in compensation if the Contractor had actual knowledge or should have known of the existence of such conditions prior to the submission of bids.

4.10 UTILITIES AND SERVICES

4.10.1 The cost of all the following will be included in the contract price and the Contractor shall be fully responsible for:

4.10.1.1 Reviewing and checking all such information and data,

4.10.1.2 Locating all underground and overhead utilities shown or indicated in the contract documents,

4.10.1.3 Coordination of the Work with the Owners of such underground and overhead utilities during construction, and

4.10.1.4 The safety and protection of all such underground and overhead utilities as provided in Section 7.17 PROTECTION OF PERSONS AND PROPERTY and repairing any damage thereto resulting from the work.

4.10.2 Unknown Utilities - During the progress of the work, if an underground utility is uncovered or revealed at or contiguous to the site which was not shown or indicated in the Contract Documents, or found at a location that is substantially different than shown or indicated in the Contract Documents, Contractor shall promptly, and before any such conditions are disturbed or damaged (except in an emergency as required by subsection 7.17.8), notify the Engineer. Contractor shall be responsible for the safety and protection of the underground utility as provided in Section 7.17 PROTECTION OF PERSONS AND PROPERTY. Refer to subsections 4.9.2 and 4.9.3.

4.10.3 If the Engineer determines a change in the Contract Documents is required, a Field Order or Change Order will be issued. Upon issuance of a duly authorized Field Order or Change Order regarding the disposition of a newly discovered utility, Contractor shall be responsible for damages to the utility, including any damage claims due to the disruption of service caused by the utility being damaged.

4.10.4 Restoration of Damaged Utilities - The Contractor shall repair and restore to pre-damaged condition any utilities or any other property it damaged. The Contractor shall be liable for any resulting damages, to the Work or to the utility owner or property owner and shall pay any claim due to the disruption of service caused by the utilities being damaged. Contractor shall defend and save harmless the State from all suits, actions or claims of any character brought on account of such damages, whether or not the State may have been partially at fault. Contractor shall obtain public liability and property damage insurance pursuant to Article 7 PROSECUTION AND PROGRESS to cover such risk of damage.

4.10.5 In the event the Contractor, simultaneously with the discovery of an unknown utility or other property, damages that utility or other property, the Contractor shall immediately notify the Engineer. If the Contractor is without fault in such a situation, notwithstanding subsection 4.10.4, the Contractor shall not be liable for resulting damages or the defense of the State from claims brought on account of said damages to unknown utilities or other property. Upon instruction from the Engineer, the Contractor shall repair all damages and execute a plan for dealing with the damaged utility or other property. This repair work shall be considered additional work as covered in Section 4.2 CHANGES.

ARTICLE 5 - Control of Work

5.1 AUTHORITY OF THE ENGINEER

5.1.1 The Engineer shall make final and conclusive decisions on all questions which may arise relating to the quality and acceptability of the materials furnished and work performed, the manner of performance and rate of progress of the work, the interpretation of the Contract Documents, the acceptable fulfillment of the contract on the part of the Contractor, the compensation under the Contract and the mutual rights of the parties to the Contract.

5.1.2 The Engineer shall have the authority to enforce and make effective such decisions and orders at the Contractor's expense when the Contractor fails to carry such decisions and orders out promptly and diligently.

5.1.3 The Engineer shall have the authority to suspend the work wholly or in part as provided in Section 7.24 SUSPENSION OF WORK.

5.1.4 The Engineer may delegate specific authority to act for the Engineer to a specific person or persons. Such delegation of authority shall be established in writing to the Contractor.

5.2 AUTHORITY OF THE INSPECTOR

5.2.1 The Inspector shall observe and inspect the contract performance and materials. The Inspector does not have any authority vested in the Engineer unless specifically delegated in writing.

5.2.2 The Inspector may offer advice and recommendations to the Contractor, but any such advice or recommendations are not directives from the Engineer.

5.2.3 The Inspector has no authority to allow deviations from the Contract Documents and may reject any and all work that the Inspector deems is not in conformity with the contract requirements. Failure of an Inspector at any time to reject non-conforming work shall not be considered a waiver of the Department's right to require work in strict conformity with the Contract Documents as a condition of final acceptance.

5.3 AUTHORITY OF CONSULTANT(S) - The Department may engage Consultant(s) for limited or full observation to supplement the inspections performed by the State and respective Counties. Unless otherwise specified in writing to the Contractor, such retained Consultant(s) will have the authority of a Project Inspector.

5.4 SHOP DRAWINGS AND OTHER SUBMITTALS

5.4.1 The following documents shall be submitted where required by the contract documents:

5.4.1.1 Shop Drawings

(1) The Contractor shall prepare, and thoroughly check, approve, all shop drawings, including those prepared by subcontractors or any other persons. The Contractor shall indicate its approval by stamping and signing each drawing. Any shop drawing submitted without being reviewed, stamped and signed will be considered as not having been submitted, and any delay caused thereby shall be the Contractor's responsibility.

(2) Shop drawings shall indicate in detail all parts of an item of work, including erection and setting instructions and engagements with work of other trades or other separate contractors. Shop drawings for structural steel, millwork and pre-cast concrete shall consist of

calculations, fabrication details, erection drawings and other working drawings, as necessary, to show the details, dimensions, sizes of members, anchor bolt plans, insert locations and other information necessary for the complete fabrication and erection of the structure to be constructed.

(3) All shop drawings as required by the contract, or as determined by the Engineer to be necessary to illustrate details of the Work shall be submitted to the Engineer with such promptness as to cause no delay in the work or in that of any other Contractor. Delay caused by the failure of the Contractor to submit shop drawings on a timely basis to allow for review, possible resubmittal and acceptance will not be considered as a justifiable reason for a contract time extension. Contractor, at its own risk, may proceed with the work affected by the shop drawings before receiving acceptance; however the Department shall not be liable for any costs or time required for the correction of work done without the benefit of accepted shop drawings.

(4) It is the Contractor's obligation and responsibility to check all of its and its subcontractor's shop drawings and be fully responsible for them and for coordination with connecting and other related work. The Contractor shall prepare, and submit to the Engineer coordination drawings showing the installation locations of all plumbing, piping, duct and electrical work including equipment throughout the project. By approving and submitting shop drawings, the Contractor thereby represents that it has determined and verified all field measurements and field construction criteria, or will do so, and that it has checked and coordinated each shop drawing with the requirements of the work and the contract documents. When shop drawings are prepared and processed before field measurements and field construction criteria can be or have been determined or verified, the Contractor shall make all necessary adjustments in the work or resubmit further shop drawings, all at no change in contract price or time.

5.4.1.2 Shop Drawing Form - Each drawing and/or series of drawings submitted must be accompanied by a letter of transmittal giving a list of the titles and number of the drawings. Each series shall be numbered consecutively for ready reference and each drawing shall be marked with the following information:

- (1) Date of Submission
- (2) Name of Project
- (3) Project Number
- (4) Location of Project
- (5) Name of submitting Contractor and Subcontractor
- (6) Revision Number

5.4.1.3 The size of the sheets that shop drawings are prepared on shall be as appropriate to suit the drawing

being presented so that the information is clearly and legibly depicted. At the determination of the Engineer, for each sheet of drawings, the submittal shall consist of either; one reproducible transparency and five prints, or eight prints.

5.4.1.4 Descriptive Sheets and Other Submittals - When a submittal is required by the contract, the Contractor shall submit to the Engineer eight (8) complete sets of descriptive sheets such as shop drawings, brochures, catalogs, illustrations, calculation, material safety data sheets (MSDS), certificates, reports, warranty, etc., which will completely describe the material, product, equipment, furniture or appliances to be used in the project as shown in the drawings and specifications and how it will be integrated into adjoining construction. When submittals are specified to be submitted under Web Based Construction Management System, the number of complete sets will be as specified or as directed by the Engineer. Prior to the submittal, the Contractor shall review and check all submittal sheets for conformity to the contract requirements and indicate such conformity by marking or stamping and signing each sheet. Where descriptive sheets include materials, systems, options, accessories, etc. that do not apply to this contract, non-relevant items shall be crossed out so that all remaining information will be considered applicable to this contract.

It is the responsibility of the Contractor to submit descriptive sheets for review and acceptance by the Engineer as required at the earliest possible date after the date of award in order to meet the construction schedule. Delays caused by the failure of the Contractor to submit descriptive sheets as required will not be considered as justifiable reasons for contract time extension.

5.4.1.5 Material Samples and Color Samples – When material and color sample submittals are required by the contract, the Contractor shall submit to the Engineer no less than three (3) samples conforming to Section 6.6 MATERIAL SAMPLES. One sample will be retained by the Consultant, one sample will be retained by the State, and the remaining sample(s) will be returned to the contractor. Prior to the material and color submittal, the Contractor shall review and check all samples for conformity to the contract requirements and indicate such conformity by marking or stamping and signing each sample. It is the responsibility of the Contractor to submit samples for review and acceptance by the Engineer as required at the earliest possible date after the date of award in order to meet the construction schedule. Delays caused by the failure of the Contractor to submit material and color samples as required will not be considered as justifiable reasons for contract time extension.

5.4.1.6 Unless the technical sections (Divisions 2 – 16) specifically require the Contractor furnish a greater quantity of shop drawings and other submittals, the Contractor shall furnish the quantities required by this section.

5.4.2 Submittal Variances - The Contractor shall include with the submittal, written notification clearly identifying all deviations or variances from the contract drawings, specifications and other Contract Documents. The notice shall be in a written form separate from the submittal. The variances shall also be clearly indicated on the shop drawing, descriptive sheet, material sample or color sample. Failure to so notify of and identify such variances shall be grounds for the subsequent rejection of the related work or materials, notwithstanding that the submittal was accepted by the Engineer. If the variances are not acceptable to the Engineer, the Contractor will be required to furnish the item as specified or indicated on the contract documents at no additional cost or time.

5.4.3 Review and Acceptance Process - Submittals will be returned to the Contractor within twenty one (21) days (for projects on Oahu) and twenty five (25) days (for projects on the islands of Hawaii, Maui, Kauai, Molokai and Lanai) after receipt by the Engineer unless otherwise agreed between the Contractor and the Engineer or as stated elsewhere in the contract documents.

5.4.3.1 The acceptance by the Engineer of the Contractor's submittal relates only to their sufficiency and compliance with the intention of the contract. Acceptance by the Engineer of the Contractor's submittal does not relieve the Contractor of any responsibility for accuracy of dimensions, details, and proper fit, and for agreement and conformity of submittal with the contract drawings and specifications. Nor will the Engineer's acceptance relieve the Contractor of responsibility for variance from the contract documents unless the Contractor, at the time of submittal, has provided notice and identification of such variances required by this section. Acceptance of a variance shall not justify a contract price or time adjustment unless the Contractor requests such an adjustment at the time of submittal and the adjustment are explicitly agreed to in writing by the Engineer. Any such request shall include price details and proposed scheduling modifications. Acceptance of a variance is subject to all contract terms, stipulations and covenants, and is without prejudice to any and all rights under the surety bond.

5.4.3.2 If the Engineer returns a submittal to the Contractor that has been rejected, the Contractor, so as not to delay the work, shall promptly make a resubmittal conforming to the requirements of the contract documents and indicating in writing on the transmittal and the subject submittal what portions of the resubmittal has been altered in order to meet the acceptance of the Engineer. Any other differences between the resubmittal and the prior submittal shall also be specifically described in the transmittal.

5.4.3.3 No mark or notation made by the Engineer on or accompanying the return of any submittal to the Contractor shall be considered a request or order for a change in work. If the Contractor believes any such mark or notation constitutes a request for a change in the work for which it is entitled to an adjustment in contract price and/or time, the Contractor must follow the same procedures established in Section 4.2 CHANGES for oral orders, directions, instructions, interpretations or determinations from the Engineer or else lose its right to claim for an adjustment.

5.5 COORDINATION OF CONTRACT DOCUMENTS - It is the intent of the Contract Documents to describe a functionally complete Project (or part thereof) to be constructed in accordance with the Contract Documents. The Contract Documents are complementary: any requirement occurring in one document is as binding as though occurring in all. In the event of conflict or discrepancy the priorities stated in the following subparagraphs shall govern:

5.5.1 Addenda shall govern over all other Contract Documents. Subsequent addenda issued shall govern over prior addenda only to the extent specified.

5.5.2 SPECIAL CONDITIONS and Proposal shall govern over the GENERAL CONDITIONS and Specifications.

5.5.3 Specifications shall govern over drawings.

5.5.4 Specification Error - Should an error or conflict appear within the specification, the Contractor shall immediately notify the Engineer. The Engineer shall promptly issue instructions as to procedure. Any requirement occurring in one or more parts of the specification is as binding as though occurring in all applicable parts.

5.5.4.1 Should an error or conflict appear within a specification section, between a listed manufacturer / product and the performance requirements of the specification section, the performance requirements shall govern.

5.5.5 Drawings:

5.5.5.1 Schedules shall govern over all other notes and drawings.

5.5.5.2 Bottom elevations of footings shown on drawings shall govern over a general note such as: "All footings shall rest on firm, undisturbed soil and extend a minimum of a certain number of feet into natural or finish grade, whichever is lower."

5.5.5.3 Except for drawing schedules and bottom elevations as noted above, general notes shall govern over all other portions of the drawings:

5.5.5.4 Larger scale drawings shall govern over smaller scale drawings.

5.5.5.5 Figured or numerical dimensions shall govern over dimensions obtained by scaling. Measurements from the drawings when scaled shall be subject to the approval of the Engineer.

5.5.5.6 In cases of discrepancies in the figures or drawings, the discrepancies shall be immediately referred to the Engineer without whose decision said discrepancy shall not be corrected by the Contractor save at its own risk and in the settlement of any complications arising from such adjustment without the knowledge and consent of the Engineer, the Contractor shall bear all extra expense involved.

5.5.5.7 Items shown on the drawings that are completely void in terms of description, details, quality and / or performance standards in both the drawings and specifications to make a price determination shall be considered an omission and the Contractor shall immediately refer same to the Engineer for a decision.

5.5.5.8 Where there is a conflict between the architectural sheets and the civil or landscaping or electrical sheets, etc., the conflict shall be considered a discrepancy and the Contractor shall immediately refer same to the Engineer for a decision.

5.5.5.9 Any requirement occurring in one or more of the sheets is as binding as though occurring in all applicable sheets.

5.6 INTERPRETATION OF DRAWINGS AND SPECIFICATIONS - The Contractor shall carefully study and compare the Contract Documents with each other, with field conditions and with the information furnished by the State and shall at once report to the Engineer errors, conflicts, ambiguities, inconsistencies or omissions discovered. Should an item not be sufficiently detailed or explained in the Contract Documents, Contractor shall report and request the Engineer' clarification and interpretation. The Engineer will issue a clarification or interpretation that is consistent with the intent of and reasonably inferred from Contract Documents.

5.7 EXAMINATION OF DRAWINGS, SPECIFICATIONS, PROJECT SITE

5.7.1 The Contractor shall examine carefully the Project Site to become familiar with the conditions to be encountered in performing the Work and the requirements of the Contact Documents.

5.7.1.1 No extra compensation will be given by reason of the Contractor's misunderstanding or lack of knowledge of the requirements of the Work to be accomplished or the conditions to be encountered in performing the project.

5.7.1.2 No extra compensation will be given by reason of the Contractor's misunderstanding or lack of knowledge when the existence of differing site, subsurface or physical conditions could have been reasonably discovered or revealed as a result of any examination, investigation, exploration, test or study of the site and contiguous areas required by the Bidding requirements or Contract Documents to be conducted by or for the Contractor.

5.7.2 When the Contract Drawings include a log of test borings showing a record of the data obtained by the Department's investigation of subsurface conditions, said log represents only the opinion of the Department as to the character of material encountered in its test borings and at only the location of each boring. The Contractor acknowledges that underground site conditions in Hawaii vary widely. There is no warranty, either expressed or implied, that the conditions indicated are representative of those existing throughout the work or any part of it, or that other conditions may not occur.

5.7.3 Reference is made to the SPECIAL CONDITIONS for identification of subsurface investigations, reports, explorations and tests utilized by the State in preparation the Contract Documents. Such reports, drawings, boring logs etc. are not part of the Contract Documents.

5.8 COOPERATION BETWEEN THE CONTRACTOR AND THE DEPARTMENT

5.8.1 Furnishing Drawings and Specifications - Contractor to supply copies of the Contract Drawings and Specifications. Contractor shall have and maintain at least one copy of the Contract Drawings and Specifications on the work site, at all times. Contractor shall cooperate with the Engineer, the Inspector(s), and other contractors in every possible way.

5.8.2 Superintendent - The Contractor shall have a competent superintendent or agent on the work site while work is being performed under the contract. The superintendent or agent shall be experienced in the type of project being undertaken and the work being performed. The superintendent or agent shall represent the Contractor and shall have the authority to act on behalf of the Contractor. Communications given to the superintendent or agent shall be as binding as if given to the Contractor.

5.8.2.1 If the superintendent or agent is not present at the work site, the Engineer shall have the right to suspend

the work as described under Section 7.24 SUSPENSION OF WORK.

5.8.2.2 The Contractor shall file with the Engineer a written statement giving the name of the superintendent or agent assigned to the project. The Contractor shall be responsible for notifying the Engineer in writing of any change in the superintendent or agent.

5.8.2.3 The requirements of this subsection 5.8.2 may be waived by the Engineer.

5.8.3 Engineering Work - The Contractor shall properly and accurately lay out the work, perform all engineering work, and furnish all engineering materials and equipment required to establish and maintain all lines, grades, dimensions and elevations called for in the drawings or required in the progress of construction, unless otherwise noted in the contract documents. The Contractor will be held definitely and absolutely responsible for any errors in lines, grades, dimensions and elevations and shall at once, on instruction from the Engineer, correct and make good such errors or any errors, or faults in the work resulting from errors in engineering performed under the requirements of its contract to the entire satisfaction of the Engineer. Full compensation for the work shall be included in the prices paid for contract items of work. No additional allowance will be made for the correction of incorrect engineering work.

5.8.3.1 The Engineer shall furnish the requisite bench elevations.

5.8.3.2 The Contractor shall locate and verify all lines, grades, dimensions and elevations indicated on the drawings before any excavation, or construction begins. Any discrepancy shall be immediately brought to the attention of the Engineer, any change shall be made in accordance with the Engineer's instruction.

5.8.3.3 The Contractor shall verify all street survey monuments (horizontal and vertical alignment) prior to final acceptance by the Engineer in accordance with any governmental requirements.

5.8.3.4 The Contractor shall provide a surveyor or Civil Engineer licensed in the State of Hawaii to verify and establish all lines, grades, dimensions and elevations.

5.8.4 Use of Structure or Improvement - The Department shall have the right, at any time during construction of the structure or improvements, to enter same for the purpose of installing by government labor or by any other Contractor or utility any necessary work in connection with the installation of facilities, it being mutually understood and agreed, however, that the Contractors, utilities and the Department will, so far as possible work to the mutual advantage of all, where their

several works in the above mentioned or in unforeseen instances touch upon or interfere with each other.

As a convenience to those involved, the Engineer shall allocate the work and designate the sequence of construction in case of controversy between Contractors on separate projects under State jurisdiction.

5.8.4.1 The Department shall also have the right to use the structure, equipment, improvement or any part thereof, at any time after it is considered by the Engineer as available. In the event that the structure, equipment or any part thereof is so used, the Department shall be responsible for all expenses incidental to such use and any damages resulting from the Department's use.

5.8.4.2 Equipment warranty will commence to run before the work is complete when and if the Department begins actual use of the equipment for the purpose for which the equipment was designed and installed.

5.8.4.3 If the Department enters the structure for construction and / or occupancy and the Contractor is delayed because of interference by the Department or by extra work resulting from damage which the Contractor is not responsible for, or by extraordinary measures the Contractor must take to accommodate the Department, the Contractor shall be granted an extension of time in accordance with Section 7.21 CONTRACT TIME. However, if such use increases the cost or delays the completion of the remaining portions of work, the Contractor shall be entitled to such extra compensation or extension of time or both, as the State may determine to be proper. Any additional work necessary will be paid in accordance with Section 8.3 PAYMENT FOR ADDITIONAL WORK.

5.9 INSPECTION - The Engineer, the Department's consultants, Inspectors employed by the Department and other representatives duly authorized by the Department shall at all times have access to the work during its construction and shall be furnished with every reasonable facility for ascertaining at any time that the materials and the workmanship are in accordance with the requirements and intentions of the contract. All work done and all materials furnished shall be subject to inspection and acceptance.

5.9.1 Such inspection and approval may extend to all or part of the work, and to the preparation, fabrication or manufacture of the materials to be used. By entering into a contract for the supply of materials, equipment or performance of labor in connection with the Work, such Material and Equipment Supplier or Labor Contractor consents to and is subject to the terms of this Section 5.9 to the same extent as the Contractor.

5.9.2 Authority to Suspend Operations - The Inspector shall have the authority to suspend operations of any work

being improperly performed by issuing a written order giving the reason for shutting down the work. Should the Contractor disregard such written order, the work done thereafter will not be accepted nor paid for.

5.9.3 The inspection of the work shall not relieve the Contractor of any of its obligations to fulfill the contract as prescribed. Notwithstanding prior payment and acceptance by the Engineer, defective and nonconforming work shall be corrected to comply with the contract requirements. Unsuitable, unspecified or unapproved materials may be rejected.

5.9.4 Federal Agency Inspection - Projects financed in whole or in part with Federal funds shall be subject to inspection and corrective requirements at all times by the Federal Agency involved at no cost to the State.

5.10 REMOVAL OF DEFECTIVE, NON-CONFORMING AND UNAUTHORIZED WORK

5.10.1 All work which has been rejected as not conforming to the requirements of the Contract shall be remedied or removed and replaced by the Contractor in an acceptable manner and no compensation will be allowed for such removal or replacement. Any work done beyond the work limits shown on the drawings and specifications or established by the Engineer or any additional work done without written authority will be considered as unauthorized and will not be paid for. Work so done may be ordered removed at the Contractor expense.

5.10.2 Scheduling Corrective Work - The Contractor shall perform its corrective or remedial work at the convenience of the State and shall obtain the Engineer's approval of its schedule.

5.10.3 Failure to Correct Work - Upon failure on the part of the Contractor to comply promptly with any order of the Engineer made under the provisions of this Section 5.10, the Engineer shall have authority to cause defective work to be remedied or removed and replaced, and unauthorized work to be removed, at the Contractor's expense, and to deduct the costs from any monies due or to become due the Contractor.

5.11 VALUE ENGINEERING INCENTIVE

§3-132 HAR amended by Act 149 SLH 1999 - On projects with contract amounts in excess of \$250,000, the following Value Engineering Incentive Clause shall apply to allow the Contractor to share in cost savings that ensue from cost reduction proposals it submits.

5.11.1 The Value Engineering Incentive Clause applies to all Value Engineering Change Proposals (cost reduction proposals, hereinafter referred to as (VECP) initiated and developed by the Contractor for changing the drawings, designs, specifications or other

requirements of this contract. This clause does not, however apply to any VECP unless it is identified as such by the Contractor at the time of its submission to the Engineer.

5.11.2 Value Engineering Change Proposal - All VECP must:

5.11.2.1 Result in a savings to the State of at least four thousand dollars (\$4,000) by providing less costly items than without impairing any essential functions and characteristics such as service life, reliability, economy of operation, ease of maintenance and all necessary features of the completed work.

5.11.2.2 Require, in order to be applied to this contract, a change order to this contract.

5.11.2.3 Not adversely impact on the schedule of performance or the contract completion date.

5.11.3 VECP Required Information - The VECP will be processed expeditiously and in the same manner as prescribed for any other change order proposal. As a minimum, the following information will be submitted by the Contractor with each proposal:

5.11.3.1 A description of the difference between the existing contract requirements and the VECP, and the comparative advantages and disadvantages of each including durability, service life, reliability, economy of operation, ease of maintenance, design safety standards, desired appearance, impacts due to construction and other essential or desirable functions and characteristics as appropriate;

5.11.3.2 An itemization of the requirements of the contract which must be changed if the VECP is adopted and a recommendation as to how to make each such change;

5.11.3.3 An estimate of the reduction in performance costs that will result from adoption of the VECP taking into account the costs of implementation by the Contractor, including any amounts attributable to subcontracts, and the basis for the estimate;

5.11.3.4 A prediction of any effects the VECP would have on other costs to the State, such as State furnished property costs, costs of related items, and costs of maintenance and operation over the anticipated life of the material, equipment, or facilities as appropriate; the construction schedule, sequence and time; and bid item totals used for evaluation and payment purposes;

5.11.3.5 A statement of the time by which a change order adopting the VECP must be issued so as to obtain the maximum cost reduction during the remainder of this contract noting any effect on the contract time; and

5.11.3.6 The dates of any previous submissions of the VECP, the numbers of any Government contracts under which submitted and the previous actions by the Government, if known.

5.11.4 Required Use of Licensed Architect or Engineer - When, in the judgment of the Engineer, a VECP alters the design prepared by a registered professional architect or engineer, the Contractor shall ensure the changes to be prepared are by or under the supervision of a licensed professional architect or engineer, and stamped and so certified.

5.11.5 Unless and until a change order applies a VECP to a contract, the Contractor shall remain obligated to perform in accordance with the terms of the contract and the Department shall not be liable for delays incurred by the Contractor resulting from the time required for the Department's determination of the acceptability of the VECP.

5.11.5.1 The determination of the Engineer as to the acceptance of any VECP under a contract shall be final.

5.11.6 Acceptance of VECP - The Engineer may accept in whole or in part any VECP submitted pursuant to this section by issuing a change order to the contract. Prior to issuance of the change order, the Contractor shall submit complete final contract documents similar to those of the original contract showing the accepted changes and the new design and features as well as the following:

5.11.6.1 Design calculations;

5.11.6.2 The design criteria used; and

5.11.6.3 A detailed breakdown of costs and expenses to construct or implement such revisions.

5.11.6.4 The change order will identify the final VECP on which it is based.

5.11.7 VECP Price Adjustments - When a VECP is accepted under a contract, an adjustment in the contract price shall be made in accordance with Section 4.4 PRICE ADJUSTMENT. The adjustment shall first be established by determining the effect on the Contractor's cost of implementing the change, including any amount attributable to subcontractors and to the Department's charges to the Contractor for architectural, engineering, or other consultant services, and the staff time required to examine and review the proposal. The contract price shall then be reduced by fifty percent (50%) of the net estimated decrease in the cost of performance.

5.11.8 The Contractor may restrict the Department's right to use the data or information or both, on any sheet

of a VECP or of the supporting data, submitted pursuant to this paragraph, if it is stated on that sheet as follows:

5.11.8.1 “This data or information or both shall not be disclosed outside the Department or be duplicated, used, or disclosed, in whole or in part, for any purpose other than to evaluate this VECP. This restriction shall not limit the Department’s right to use this data or information or both if obtained from another source, or is otherwise available, without limitations. If this VECP is accepted by the Department by issuance of a change order after the use of this data or information or both in such an evaluation, the Department shall have the right to duplicate, use and disclose any data or information or both pertinent to the proposal as accepted in any manner and for any purpose whatsoever and have others so do.”

5.11.9 In the event of acceptance of a VECP, the Department shall have all rights to use, duplicate or disclose in whole or in part in any manner and for any purpose whatsoever, and to have or permit others to do so, any data or information or both reasonably necessary to fully utilize such proposal.

5.11.10 The Contractor shall submit with each VECP all required information and provide all additional information as may be required by the Engineer to evaluate and implement the VECP. The cost for preparing the VECP shall be the Contractor’s responsibility, and any part of the Contractor’s cost for implementing the change shall be due only when the proposal is accepted and a change order is issued.

5.11.11 If the services of the Department’s architect, engineer or consultant is necessary to review and evaluate a VECP, the cost therefore shall be paid for by the Contractor.

5.11.12 Each VECP shall be evaluated as applicable to this contract, and past acceptance on another Department project for a similar item shall not be automatic grounds for approval.

5.11.13 The method by which the Contractor will share a portion of the cost savings from an accepted VECP shall be for this contract only, and no consideration shall be made for future acquisition, royalty type payment or collateral savings.

5.11.13.1 The Department may accept the proposed VECP in whole or in part. The Engineer shall issue a contract change order to identify and describe the accepted VECP.

5.12 SUBCONTRACTS - Nothing contained in the contract documents shall create a contractual relationship between the State and any subcontractor. The contractor may subcontract a portion of the work but the contractor

shall remain responsible for the work that is subcontracted.

5.12.1 Replacing Subcontractors - Contractors may enter into subcontracts only with subcontractors listed in the offer form. The contractor will be allowed to replace a listed subcontractor if the subcontractor:

5.12.1.1 Fails, refuses or is unable to enter into a subcontract consistent with the terms and conditions of the subcontractor’s offer presented to the contractor; or

5.12.1.2 Becomes insolvent; or

5.12.1.3 Has any license or certification necessary for performance of the work suspended or revoked; or

5.12.1.4 Has defaulted or has otherwise breached the subcontract in connection with the subcontracted work; or

5.12.1.5 Agrees to be substituted by providing a written release; or

5.12.1.6 Is unable or refuses to comply with other requirements of law applicable to contractors, subcontractors, and public works projects.

5.12.2 Notice of Replacing Subcontractor – The contractor shall provide a written notice to the Contracting Officer when it wishes to replace a subcontractor, including in the notice, the reasons for replacement. The contractor agrees to defend, hold harmless and indemnify the State against all claims, liabilities, or damages whatsoever, including attorneys fees arising out of or related to the replacement of a subcontractor. The contractor may not replace the subcontractor until the Contracting Officer approves of the replacement.

5.12.3 Adding Subcontractors – The Contractor may enter into a subcontract with a subcontractor that is not listed in the offer form only after this contract becomes enforceable and only after the Contracting Officer has approved the subcontractor.

5.12.4 Subcontracting - Contractor shall perform with its own organization, work amounting to not less than twenty (20%) of the total contract cost, exclusive of costs for materials and equipment the Contractor purchases for installation by its subcontractors, except that any items designated by the State in the contract as “specialty items” may be performed by a subcontract and the cost of any such specialty items so performed by the subcontract may be deducted from the total contract cost before computing the amount of work required to be performed by the Contractor with its own organization.

ARTICLE 6 - Control of Materials and Equipment

6.1 MATERIALS AND EQUIPMENT - Contractor shall furnish, pay for and install all material and equipment as called for in the drawings and specifications. Materials and equipment shall be new and the most suitable for the purpose intended unless otherwise specified. The State does not guarantee that the specified or pre-qualified product listed in the drawings and specifications are available at the time of bid or during the contract period.

6.2 SOURCE OF SUPPLY AND QUALITY OF MATERIALS

6.2.1 Only materials conforming to the drawings and specifications and, when required by the contract have been accepted by the Engineer, shall be used. In order to expedite the inspection and testing of materials, at the request of the Engineer, the Contractor shall identify its proposed sources of materials within ten (10) days after notification by the Engineer.

6.2.2 At the option of the Engineer, the materials may be accepted by the Engineer at the source of supply before delivery is started. Representative preliminary samples of the character and quantity prescribed shall be submitted by the Contractor or producer for examination and tested in accordance with the methods referred to under samples and tests.

6.2.3 Engineer's Authorization to Test Materials - Materials proposed to be used may be inspected and tested whenever the Engineer deems necessary to determine conformance to the specified requirements. The cost of testing shall be borne by the Contractor. However, should test results show that the material(s) is in compliance with the specified requirements, the cost of the testing will be borne by the State.

6.2.4 Unacceptable Materials - In the event material(s) are found to be unacceptable, the Contractor shall cease their use, remove the unacceptable material(s) that have already been installed or applied, and furnish acceptable materials all at no additional cost to the State. No material which is in any way unfit for use shall be used.

6.3 SUBSTITUTION AFTER CONTRACT AWARD

6.3.1 Materials, equipment, articles and systems noted on the drawings and specifications, establish a standard of quality, function, performance or design requirements and shall not be interpreted to limit competition. Should trade names, makes, catalog numbers or brand names be specified, the contractor shall infer that these items indicate the quality, style, appearance or performance of the material, equipment, article, or systems to be used in the project. The contractor is responsible to use materials, equipment, articles or systems that meet the project requirements. Unless specifically provided otherwise in

the contract documents, the contractor may, at its option, use any material equipment, article or system that, in the judgment of the Contracting officer, is equal to that required by the contract documents.

6.3.1.1 If after installing a material, equipment, article or system a variance is discovered, the contractor shall immediately replace the material, equipment, article or system with one that meets the requirements of the contract documents.

6.3.2 Substitution After Contract Award - Subject to the Contracting Officer's determination; material, equipment, article or system with a variant feature(s) may be allowed as a substitution, provided it is in the State's best interest. The State may deny a substitution; and if a substitution is denied, the contractor is not entitled to any additional compensation or time extension.

6.3.2.1 The contractor shall include with the submittal, a notification that identifies all deviations or variances from the contract documents. The notice shall be in a written form separate from the submittal. The variances shall be clearly shown on the shop drawing, descriptive sheet, and material sample or color sample; and the contractor shall certify that the substitution has no other variant features. Failures to identify the variances are grounds to reject the related work or materials, notwithstanding that the Contracting Officer accepted the submittal. If the variances are not acceptable to the Contracting Officer, the contractor will be required to furnish the item as specified on the contract documents at no additional cost or time.

6.3.2.2 Acceptance of a variance shall not justify a contract price or time adjustment unless the contractor requests an adjustment at the time of submittal and the adjustments are explicitly agreed to in writing by the Contracting Officer. Any request shall include price details and proposed scheduling modifications. Acceptance of a variance is subject to all contract terms, and is without prejudice to all rights under the surety bond.

6.3.2.3 The contractor can recommend improvements to the project, for materials, equipment, articles, or systems by means of a substitution request, even if the improvements are at an additional cost. The Contracting Officer shall make the final determination to accept or reject contractor's proposed improvements. If the proposal material, equipment, article or system cost less than the specified item, the Department will require a sharing of cost similar to value engineering be implemented. State reserves its right to deny a substitution; and if a substitution is denied, the contractor is not entitled to additional compensation or time extension.

6.3.2.4 If the specified material and / or equipment inadvertently lists only a single manufacturer.

6.3.3 A substitution request after Contract Award shall be fully explained in writing. Contractor shall provide brochures showing that the substitute material and / or equipment is equal or better in essential features and also provide a matrix showing comparison of the essential features. Contractor shall justify its request and include quantities and unit prices involved, respective supplier's price quotations and such other documents necessary to fully support the request. Any savings in cost will be credited to the Department. Contractor shall absorb any additional cost for the substitute item(s) or for its installation. Submitting a substitution request, does not imply that substitutions, for brand name specified materials and equipment, will be allowed. The Engineer may reject and deny any request deemed irregular or not in the best interest of the Department. A request for substitution shall not in any way be grounds for an extension of contract time. At the discretion of the Engineer, a time extension may be granted for an approved substitution.

6.4 ASBESTOS CONTAINING MATERIALS - The use of materials or equipment containing asbestos is prohibited under this contract. Contractor warrants that all materials and equipment incorporated in the project are asbestos-free.

6.5 TEST SAMPLES

6.5.1 The Engineer may require any or all materials to be tested by means of samples or otherwise. Contractor shall collect and forward samples requested by the Engineer. Contractor shall not use or incorporate any material represented by the samples until all required tests have been made and the material has been accepted. In all cases, the Contractor shall furnish the required samples without charge. Where samples are required from the completed work, the Contractor shall cut and furnish samples from the completed work. Samples so removed shall be replaced with identical material and refinished. No additional compensation will be allowed for furnishing test samples and their replacement with new materials.

6.5.2 Tests of the material samples will be made in accordance with the latest standards of the American Society for Testing and Materials (ASTM), as amended prior to the contract date unless otherwise provided. In cases where a particular test method is necessary or specifications and serial numbers are stipulated, the test shall be made by the method stated in the above-mentioned publication. Where the test reference is the American Association of State Highway and Transportation Officials (AASHTO), it means the specifications and serial numbers of the latest edition and amendments prior to the bid date.

6.5.3 The Engineer may retest any materials which have been tested and accepted at the source of supply after the same has been delivered to the work site. The Engineer shall reject all materials which, when retested, do not meet the requirements of the contract.

6.6 MATERIAL SAMPLES

6.6.1 The Contractor shall furnish all samples required by the drawings and specifications or that may be requested by the Engineer of any and all materials or equipment it proposes to use. Unless specifically required, samples are not to be submitted with the bid.

6.6.2 No materials or equipment of which samples are required shall be used on the Work until the Engineer has received and accepted the samples. If the Contractor proceeds to use such materials before the Engineer accepts the samples, the Contractor shall bear the risk.

6.6.3 Contractor shall furnish two (2) copies of a transmittal letter with each shipment of samples. The letter shall provide a list of the samples, the name of the building or work for which the materials are intended and the brands of the materials and names of the manufacturers. Also, each sample submitted shall have a label indicating the material represented, its place of origin, the names of the producer, the Contractor and the building or work for which the material is intended. Samples of finished materials shall be marked to indicate where the materials represented are required by the drawings or specifications.

6.6.4 Acceptance of any sample(s) shall be only for the characteristics or for the uses named in such acceptance and for no other purpose. Acceptance of samples shall not change or modify any contract requirement. All samples will be provided by the Contractor at no extra cost to the Department. See also Section 5.4 SHOP DRAWINGS AND OTHER SUBMITTALS.

6.7 NON-CONFORMING MATERIALS - All materials not conforming to the requirements of these contract documents, whether in place or not, shall be rejected and removed immediately from the site of work unless otherwise permitted by the Engineer in writing. No rejected material which has subsequently been made to conform shall be used unless and until written acceptance has been given by the Engineer. If the Contractor fails to comply forthwith with any order of the Engineer made under the provisions of this Section 6.7, the Engineer shall have the authority to remove and replace non-conforming materials and charge the cost of removal and replacement to the Contractor.

6.8 HANDLING MATERIALS - Contractor shall handle all materials to preserve their quality and fitness

for work. Transport aggregates from the source or storage site to the work in tight vehicles to prevent loss or segregation of materials after loading and measuring.

6.9 STORAGE OF MATERIALS - Contractor shall store all materials to preserve their quality and fitness for the work. Unless otherwise provided, any portion of the project site within the Project Contract Limit not required for public travel, may be used for storage purposes and for the Contractor's plant and equipment. Any additional space required shall be provided by the Contractor at its expense subject to the Engineer's acceptance. Contractor shall store materials on wooden platforms or other hard, clean surfaces and covered to protect it from the weather and damage. Stored materials shall be located to allow prompt inspection.

6.10 PROPERTY RIGHTS IN MATERIALS - Nothing in the contract shall be construed to vest in the Contractor any right to any materials and equipment after such materials and equipment have been attached, affixed to, or placed in the work.

6.11 ASSIGNMENT OF ANTITRUST CLAIMS FOR OVERCHARGES FOR GOODS PURCHASED - Contractor (or Vendor) and the Department recognize that in actual economic practice, overcharges resulting from antitrust violations are in fact usually borne by the Department. Therefore, Contractor hereby assigns to the Department any and all claims for such overcharges as to goods purchased in connection with this order or contract, except as to overcharges which result from antitrust violations commencing after the price is established under this order or contract and any change order. In addition, Contractor warrants and represents that each of its first tier suppliers and subcontractors shall assign any and all such claims to the Department, subject to the aforementioned exception.

ARTICLE 7 - Prosecution and Progress
(Including Legal Relations and Responsibility)

7.1 PROSECUTION OF THE WORK

7.1.1 After approval of the contract by the Department of Defense, a Notice to Proceed will be given to the Contractor as described in Section 3.10 NOTICE TO PROCEED. The Notice to Proceed will indicate the date the Contractor is expected to begin the construction and from which date contract time will be charged.

7.1.2 The Contractor shall begin work no later than ten (10) working days from the date in the Notice to Proceed and shall diligently prosecute the same to completion within the contract time allowed. The Contractor shall notify the Engineer at least three (3) working days before beginning work.

7.1.3 If any subsequent suspension and resumption of work occurs, the Contractor shall notify the Engineer at least twenty-four (24) hours before stopping or restarting actual field operations.

7.1.4 Working Prior to Notice to Proceed - The Contractor shall not begin work before the date in the Notice to Proceed. Should the Contractor begin work before receiving the Notice to Proceed, any work performed in advance of the specified date will be considered as having been done at the Contractor's risk and as a volunteer and subject to the following conditions:

7.1.4.1 Under no circumstances shall the Contractor commence work on site until it has notified the Engineer of its intentions and has been advised by the Engineer in writing that the project site is available to the Contractor. The project site will not be made available until the Contractor has complied with commencement requirements under Section 7.2 COMMENCEMENT REQUIREMENTS.

7.1.4.2 In the event the contract is not executed, the Contractor shall, at its own expense, do such work as is necessary to leave the site in a neat condition to the satisfaction of the Engineer. The Contractor shall not be reimbursed for any work performed.

7.1.4.3 All work done prior to the Notice to Proceed shall be performed in accordance with the contract documents, but will only be considered authorized work and be paid for as provided in the contract after the Notice to Proceed is issued.

7.1.5 For repairs and/or renovations of existing buildings, unless otherwise permitted by the Engineer, the Contractor shall not commence with the physical construction unless all or sufficient amount of materials are available for either continuous construction or completion of a specified portion of the work. When construction is started, the Contractor shall work expeditiously and pursue the work diligently until it is complete. If only a portion of the work is to be done in stages, the Contractor shall leave the area safe and usable for the user agency at the end of each stage.

7.2 COMMENCEMENT REQUIREMENTS - Prior to beginning work on site, the Contractor shall submit the following to the Engineer:

7.2.1 Identification of the Superintendent or authorized representative on the job site. Refer to Section 5.8 COOPERATION BETWEEN THE CONTRACTOR AND THE DEPARTMENT.

7.2.2 Proposed Working Hours on the job. Refer to Section 7.5 NORMAL WORKING HOURS.

7.2.3 Permits and Licenses. Refer to Section 7.4 PERMITS AND LICENSES.

7.2.4 Schedule of Prices to be accepted for the agreed Monthly Payment Application. Unless the proposal provides unit price bids on all items in this project, the successful Bidder will be required, after the award of contract, to submit a schedule of prices for the various items of construction included in the contract. For projects involving more than a single building and / or facility, the breakdown cost shall reflect a separate schedule of prices for the various items of work for each building and/or facility. The sum of the prices submitted for the various items must equal the lump sum bid in the Bidder's proposal. This schedule will be subject to acceptance by the Engineer who may reject same and require the bidder to submit another or several other schedules if in the Engineer's opinion the prices are unbalanced or not sufficiently detailed. This schedule of prices shall be used for the purpose of determining the value of monthly payments due the Contractor for work installed complete in place; and may be used as the basis for determining cost and credit of added or deleted items of work, respectively.

7.2.4.1 The Contractor shall estimate at the close of each month the percentage of work completed under each of the various construction items during such month and submit the Monthly Payment Application to the Engineer for review and approval. The Contractor shall be paid the approved percentage of the price established for each item less the retention provided in Section 8.4 PROGRESS PAYMENTS.

7.2.5 Proof of Insurance Coverage. Certificate of Insurance or other documentary evidence satisfactory to the Contracting Officer that the Contractor has in place all insurance coverage required by the contract. The Certificate of Insurance shall contain wording which identifies the Project number and Project title for which the certificate of insurance is issued. Refer to Section 7.3 INSURANCE REQUIREMENTS.

7.2.6 Until such time as the above items are processed and approved, the Contractor shall not be allowed to commence on any operations unless authorized by the Engineer.

7.3 INSURANCE REQUIREMENTS

7.3.1 Obligation of Contractor - Contractor shall not commence any work until it obtains, at its own expense, all required herein insurance. Such insurance shall be provided by an insurance company authorized by the laws of the State to issue such insurance in the State of Hawaii. Coverage by a "Non-Admitted" carrier is permissible provided the carrier has a Best's Rating of "A-VII" or better.

7.3.2 All insurance described herein will be maintained by the Contractor for the full period of the contract and in no event will be terminated or otherwise allowed to lapse prior to written certification of final acceptance of the work by the State.

7.3.3 Certificate(s) of Insurance acceptable to the State shall be filed with the Engineer prior to commencement of the work. Certificates shall identify if the insurance company is a "captive" insurance company or a "Non-Admitted" carrier to the State of Hawaii. The best's rating must be stated for the "Non-Admitted" carrier. Certificates shall contain a provision that coverage's being certified will not be cancelled or materially changes without giving the Engineer at least thirty (30) days prior written notice. If the State is to be an Additional Insured on any of the required insurance, it shall be so noted on the certificate. Should any policy be canceled before final acceptance of the work by the State, and the Contractor fails to immediately procure replacement insurance as specified, the State, in addition to all other remedies it may have for such breach, reserves the right to procure such insurance and deduct the cost thereof from any money due to the Contractor.

7.3.4 Nothing contained in these insurance requirements is to be construed as limiting the extent of Contractor's responsibility for payment of damages resulting from its operations under this contract, including the Contractor's obligation to pay performance liquidated damages, nor shall it affect the Contractor's separate and independent duty to defend, indemnify and hold the State harmless pursuant to other provisions of this contract. In no instance will the State's exercise of an option to occupy and use completed portions of the work relieve the Contractor of its obligation to maintain the required insurance until the date of final acceptance of the work.

7.3.5 All insurance described herein shall be primary and cover the insured for all work to be performed under the contract, all work performed incidental thereto or directly or indirectly connected therewith, including traffic detour work or other work performed outside the work area and all change order work.

7.3.6 The Contractor shall, from time to time, furnish the Engineer, when requested, satisfactory proof of coverage of each type of insurance required covering the work. Failure to comply with the Engineer's request may result in suspension of the work, and shall be sufficient grounds to withhold future payments due the Contractor and to terminate the contract for Contractor's default.

7.3.7 Types of Insurance - Contractor shall purchase and maintain insurance described below which shall provide coverage against claims arising out of the Contractor's operations under the contract, whether such operations be by the Contractor itself or by any subcontractor or by anyone directly or indirectly

employed by any of them or by anyone for whose acts any of them may be liable.

7.3.7.1 Worker's Compensation -The Contractor shall obtain worker's compensation insurance for all persons whom they employ in carrying out the work under this contract. This insurance shall be in strict conformity with the requirements of the most current and applicable State of Hawaii Worker's Compensation Insurance laws in effect on the date of the execution of this contract and as modified during the duration of the contract.

7.3.7.2 General Liability - The Contractor shall obtain General Liability insurance with a limit of not less than \$2,000,000 per occurrence and in the Aggregates. The General liability insurance shall include the State as an Additional Insured. The required limit of insurance may be provided by a single policy or with a combination of primary and excess policies. Refer to SPECIAL CONDITIONS for any additional requirements.

7.3.7.3 Auto Liability - The Contractor shall obtain Auto Liability Insurance covering all owned, non-owned and hired autos with a combined single Limit of not less than \$1,000,000 per occurrence. The required limit of insurance may be provided by a single policy or with a combination of primary and excess policies. Refer to SPECIAL CONDITIONS for any additional requirements.

7.3.7.4 Property Insurance (Builders Risk)

- (1) New Building(s) - The Contractor shall obtain Property Insurance covering building(s) being constructed under this Contract. The limit shall be equal to the completed value of the building(s) and shall insure against all-loss excluding earthquakes and floods. The coverage shall be provided by a company authorized to write insurance in the State of Hawaii as an insurer.
- (2) Building Renovation and / or Installation Contract - The Contractor shall obtain Property Insurance with a limit equal to the completed value of the work or property being installed and shall insure against all-loss excluding earthquakes and floods. The coverage shall be provided by a company authorized to write insurance in the State of Hawaii as an insurer. Refer to SPECIAL CONDITIONS for any additional requirements.
- (3) The Contractor is not required to obtain property insurance for contracts limited to site development

7.4 PERMITS AND LICENSES

7.4.1 The State or its representative may process Federal (e.g. Corps of Engineers), State and County

Permit applications. The Contractor shall pick up the pre-processed Permits at the appropriate governmental agency and pay the required fees. Other permits necessary for the proper execution of the work such as utility connection permits, elevator installation permits etc., unless processed by the State and paid for by the Contractor, shall be obtained and paid for by the Contractor.

7.4.2 Until such time as the above permits are approved, the Contractor shall not be allowed to commence any operations without written approval of the Engineer.

7.4.3 The Engineer reserves the right to waive application and processing of the building permit.

7.5 NORMAL WORKING HOURS - Prior to beginning operations, unless otherwise established by the State, the Contractor shall notify the Engineer in writing of the time in hours and minutes, A.M. and P.M. respectively, at which it desires to begin and end the day's work. If the Contractor desires to change the working hours, it shall request the Engineer's approval three (3) consecutive working days prior to the date of the change.

7.6 HOURS OF LABOR (Section 104-2 Hawaii Revised Statutes)

7.6.1 No laborer or mechanic employed on the job site of any public work of the Department or any political sub-division thereof shall be permitted or required to work on Saturday, Sunday or a legal holiday of the State or in excess of eight hours on any other day unless the laborer or mechanic receives overtime compensation for all hours worked on Saturday, Sunday and a legal holiday of the State or in excess of eight hours on any other day. For the purposes of determining overtime compensation under this Section 7.6, the basic hourly rate of any laborer or mechanic shall not be less than the basic hourly rate determined by the Department of Labor and Industrial Relations to be the prevailing basic hourly rate for corresponding classes of laborers and mechanics on projects of similar character in the Department.

7.6.2 Overtime compensation means, compensation based on one and one-half times the laborers or mechanics basic hourly rate of pay plus the cost to an employer of furnishing a laborer or mechanic with fringe benefits.

7.7 PREVAILING WAGES - (§ 104-2 HRS)

7.7.1 The Contractor shall at all times observe and comply with all provisions of Chapter 104, HRS, the significant requirements of which are emphasized in the Department of Labor and Industrial Relations Publication No. H104-3 entitled 'Requirements of Chapter 104, HRS Wages and Hours of Employees on Public Works Law'.

7.7.2 Wage Rate Schedule - The wage rate schedule is not physically enclosed in the bid documents. However, the wage rate schedule is incorporated herein by reference and made a part of the Bid and Contract Documents. Said wage rate schedule may be obtained from the Contracts Office, Department of Accounting and General Services, 1151 Punchbowl Street, Room 422, Honolulu, Hawaii or, via the FAX-ON-DEMAND system of the Department of Labor and Industrial Relations, phone number (808) 586-8695. When the bid documents are made available on respective neighbor islands, copies of the wage rate schedule may also be obtained from the office of the respective neighbor island DAGS District Office.

7.7.3 The Contractor or its subcontractor(s) shall pay all laborers and mechanics employed on the job site, unconditionally and not less often than once a week, and without deduction or rebate on any account except as allowed by law, the full amounts of their wages including overtime, accrued to not more than five (5) working days prior to the time of payment, at wage rates not less than those stated in the contract, regardless of any contractual relationship which may be alleged to exist between the Contractor and subcontractor and such laborers and mechanics. The wages stated in the contract shall not be less than the minimum prevailing wages (basic hourly rate plus fringe benefits), as determined by the Director of Labor and Industrial Relations and published in wage rate schedules. Any increase in wage rates, as determined by the Director of Labor and Industrial Relations and issued in the wage rate schedule, shall be applicable during the performance of the contract, in accordance with section 104-2(a) and (b), Hawaii Revised Statutes. Notwithstanding the provisions of the original contract, if the Director of Labor and Industrial Relations determines that prevailing wages have increased during the performance of the contract, the rate of pay of laborers and mechanics shall be raised accordingly.

7.7.4 Posting Wage Rate Schedule - The rates of wages to be paid shall be posted by the Contractor in a prominent and easily accessible place at the job site and a copy of such wages required to be posted shall be given to each laborer and mechanic employed under the contract by the Contractor at the time the person is employed thereunder, provided that where there is a collective bargaining agreement, the Contractor does not have to provide its employees the wage rate schedules. Any revisions to the schedule of wages issued by the Director of Labor and Industrial Relations during the course of the contract shall also be posted by the Contractor and a copy provided to each laborer and mechanic employed under the contract as required above.

7.7.5 The Engineer may withhold from the Contractor so much of the accrued payments as the Engineer may consider necessary to pay to laborers and mechanics employed by the Contractor or any subcontractor on the job site. The accrued payments withheld shall be the

difference between the wages required by this contract and the wages actually received by such laborers or mechanics.

7.8 FAILURE TO PAY REQUIRED WAGES (§ 104-4, HRS) - If the Department finds that any laborer or mechanic employed on the job site by the Contractor or any subcontractor has been or is being paid wages at a rate less than the required rate by the contract, or has not received their full overtime compensation, the Department may, by written notice to the Contractor, terminate its right, or the right of any subcontractor, to proceed with the work or with the part of the work on which the required wages or overtime compensation have not been paid and may complete such work or part by contract or otherwise, and the Contractor and its sureties shall be liable to the Department for any excess costs occasioned thereby.

7.9 PAYROLLS AND PAYROLL RECORDS (§ 104-3 HRS)

7.9.1 A certified copy of each weekly payroll shall be submitted to the Engineer within seven (7) calendar days after the end of each weekly payroll period. Failure to do so on a timely basis shall be cause for disqualification from bidding in accordance with the provisions of Section 2.12 DISQUALIFICATION OF BIDDERS. The Contractor shall be responsible for the timely submission of certified copies of payrolls of all subcontractors. The certification shall affirm that payrolls are correct and complete, that the wage rates contained therein are not less than the applicable rates contained in the wage determination decision, any amendments thereto during the period of the contract, and that the classifications set forth for each laborer and mechanic conform with the work they performed.

7.9.2 Payroll records for all laborers and mechanics working at the site of the work shall be maintained by the General Contractor and its subcontractors, if any, during the course of the work and preserved for a period of four (4) years thereafter. Such records shall contain the name of each employee, their correct classification, rate of pay, daily and weekly number of hours worked, itemized deductions made and actual wages paid. Such records shall be made available for inspection at a place designated by the Engineer, the Director of Labor and any authorized persons who may also interview employees during working hours on the job site.

7.9.3 Note that the falsification of certifications noted in this Section 7.9 may subject the Contractor or subcontractor to penalties and debarment under the laws referenced in Section 7.14 LAWS TO BE OBSERVED and / or criminal prosecution.

7.9A APPRENTICESHIP AGREEMENT CERTIFICATION (HRS §103-55.6)

7.9A.1 For the duration of a contract awarded and executed utilizing the apprenticeship agreement preference, the Contractor shall certify for each month that work is being conducted on the project, that it continues to be a participant in the relevant registered apprenticeship program for each trade it employs.

7.9A.2 Monthly certification shall be made by completing the *Monthly Report of Contractor's Participation – Form 2* made available by the State Department of Labor and Industrial Relations, the original to be signed by the respective apprenticeship program sponsors authorized official, and submitted by the Contractor to the Engineer with its monthly payment requests. The *Monthly Report of Contractor's Participation – Form 2* is available on the DLIR website at: <http://hawaii.gov/labor/wdd>.

7.9A.3 Should the Contractor fail or refuse to submit its *Monthly Report of Contractor's Participation – Form 2*, or at any time during the duration of the contract, cease to be a party to a registered apprenticeship agreement for any of the apprenticeable trades the Contractor employs, or will employ, the Contractor will be subject to the following sanctions:

7.9A.3.1 Withholding of the requested payment until all of the required *Monthly Report of Contractor's Participation – Form 2s* are properly completed and submitted.

7.9A.3.2 Temporary or permanent cessation of work on the project, without recourse to breach of contract claims by the Contractor; provided the Department shall be entitled to restitution for nonperformance or liquidated damages claims; or

7.9A.3.3 Proceedings to debar or suspend pursuant to HRS §103D-702.

7.9A.4 If events such as “acts of God”, acts of public enemy, acts of the State or any other governmental body in its sovereign or contractual capacity, fires, floods, epidemics, freight embargoes, unusually severe weather, or strikes or other labor disputes prevent the Contractor from submitting the *Monthly Report of Contractor's Participation – Form 2*, the Contractor shall not be penalized as provided herein, provided the Contractor completely and expeditiously complies with the certification process when the event is over.

7.10 OVERTIME AND NIGHT WORK

7.10.1 Overtime work shall be considered as work performed in excess of eight (8) hours in any one day or work performed on Saturday, Sunday or legal holiday of the State. Overtime and night work are permissible when approved by the Engineer in writing, or as called for elsewhere within these GENERAL CONDITIONS.

7.10.2 Overtime Notification - Contractor shall notify the Engineer in writing at least two (2) working days prior to doing overtime and night work, to insure proper inspection will be available. The notification shall address the specific work to be done. A notification is not required when overtime work and night work are included as normal working hours in the contract and in the contractor's construction schedule.

7.10.3 In the event that work other than that contained in the above notification is performed and for which the Engineer determines State inspection services were necessary but not available because of the lack of notification, the Contractor may be required to remove all such work and perform the work over again in the presence of State inspection personnel.

7.10.4 Any hours worked in excess of the normal eight (8) working hours per day or on Saturdays, Sundays or legal State holidays will not be considered a working day.

7.10.5 The State hereby reserves the right to cancel the overtime, night, Saturday, Sunday or legal State holiday work when it is found that work during these periods is detrimental to the public welfare or the user agency.

7.11 OVERTIME AND NIGHT PAYMENT FOR STATE INSPECTION SERVICE

7.11.1 The Department is responsible for overtime or night time payments for Department's inspection services, including Department's Inspector, State staff personnel and the Department's Consultant(s) engaged on the project, when overtime and night work are included as normal working hours in the contract and in the contractor's construction schedule.

7.11.2 Whenever the Contractor's operations require the State's inspection and staff personnel to work overtime or at night, the Contractor shall reimburse the State for the cost of such services unless otherwise instructed in the Contract. The Engineer will notify the Contractor of the minimum number of required Department employees and other personnel engaged by the Department prior to the start of any such work. The costs chargeable to the Contractor shall include but not be limited to the following:

7.11.2.1 The cost of salaries which are determined by the State and includes overtime and night time differential for the Department's staff and inspection personnel. In addition to the cost of the salaries, the Contractor shall reimburse the State's share of contributions to the employee's retirement, medical plan, social security, vacation, sick leave, worker's compensation funds, per diem, and other applicable fringe benefits and overhead expenses.

7.11.2.2 The transportation cost incurred by the Department's staff and inspection personnel which are based on established rental rates or mileage allowance in use by the Department for the particular equipment or vehicle.

7.11.2.3 Fees and other costs billed the State by Consultants engaged on the project for overtime and/or night time work.

7.11.3 Payment for Inspection Services - The monies due the Department for staff and inspection work and use of vehicles and equipment as determined in subsection 7.11.2 shall be deducted from the monies due or to become due the Contractor. In any and all events, the Contractor shall not pay the Department's employees directly.

7.12 LIMITATIONS OF OPERATIONS

7.12.1 Contractor shall at all times conduct the work in such manner and in such sequence as will insure the least practicable interference with pedestrian and motor traffic passageways. The Contractor shall furnish convenient detours and provide and plan all other appropriate signs, flashers, personnel, warnings, barricades and other devices for handling pedestrian and motor traffic.

7.12.2 In the event that other contractors are also employed on the job site, the Contractor shall arrange its work and dispose of materials so as not to interfere with the operations of the other contractors engaged upon adjacent work. The Contractor shall join its work to that of others and existing buildings in a proper manner, and in accordance with the drawings and specifications, and perform its work in the proper sequence in relation to that of others, all as may be directed by the Engineer.

7.12.3 Each Contractor shall be responsible for any damage done by it to work performed by another contractor. Each Contractor shall so conduct its operations and maintain the work in such condition that adequate drainage shall be in effect at all times.

7.12.4 In the event that the Contractor fails to prosecute its work as provided in this Section 7.12 or disregards the directions of the Engineer, the Engineer may suspend the work until such time as the Contractor provides for the prosecution of the work with minimum interference to traffic and passageways or other contractors, adequate drainage, the repair of damage and complies with the direction of the Engineer. No payment will be made for the costs of such suspension.

7.13 ASSIGNMENT OR CHANGE OF NAME §3-125-14 HAR

7.13.1 Assignment - The Contractor shall not sublet, sell, transfer, assign or otherwise dispose of this contract or any part hereof or any right, title or interest herein or any monies due or to become due hereunder without the prior written consent of the Engineer.

7.13.2 The Contractor may assign money due or to become due it under the contract and such assignment will be recognized by the Department, if given proper notice thereof, to the extent permitted by law; but any assignment of monies shall be subject to all proper set-offs in favor of the State and to all deductions provided in the contract and particularly all monies withheld or unpaid, whether assigned or not, shall be to use by the Department for the completion of the work in the event that the Contractors should be in default therein.

7.13.3 Recognition of a Successor in Interest; Assignment - When in the best interest of the State, a successor in interest may be recognized in an assignment agreement in which the transferor and the transferee and the State shall agree that:

7.13.3.1 The transferee assumes all of the transferor's obligations;

7.13.3.2 Transferor remains liable for all obligations under the contract but waives all rights under the contract against the State; and

7.13.3.3 The transferor shall continue to furnish, and the transferee shall also furnish, all required bonds.

7.13.4 Change of Name - When a Contractor requests to change the name in which it holds a contract with the State, the Engineer shall, upon receipt of a document indicating such change of name (for example: an amendment to the articles of incorporation of the corporation), enter into an agreement with the requesting Contractor to effect such a change of name. The agreement changing the name shall specifically indicate that no other terms and conditions of the contract are thereby changed.

7.13.5 All change of name or novation agreements effected hereunder other than by the Engineer shall be reported to the Engineer within thirty (30) days of the date that the agreement becomes effective.

7.13.6 Notwithstanding the provisions of paragraphs 7.13.3.1 through 7.13.3.3 above, when a Contractor holds contracts with more than one purchasing agency of the State, the novation or change of name agreements herein authorized shall be processed only through the Department of Defense, State of Hawaii.

7.14 LAWS TO BE OBSERVED

7.14.1 The Contractor at all times shall observe and comply with all Federal, State and local laws or ordinances, rules and regulations which in any manner affect those engaged or employed in the work, the materials used in the work, and the conduct of the work. The Contractor shall also comply with all such orders and decrees of bodies or tribunals having any jurisdiction or authority over the work. Any reference to such laws, ordinances, rules and regulations shall include any amendments thereto before and after the date of this contract.

7.14.2 The Contractor shall defend, protect, hold harmless and indemnify the State and its Departments and Agencies and all their officers, representatives, employees or agents against any claim or liability arising from or based on the violation of any such laws, ordinances, rules and regulations, orders or decrees, whether such violation is committed by the Contractor or its Subcontractor(s) or any employee of either or both. If any discrepancy or inconsistency is discovered in the contract for the work in relation to any such laws, ordinances, rules and regulations, orders or decrees, the Contractor shall forthwith report the same to the Engineer in writing.

7.14.3 While the Contractor must comply with all applicable laws, attention is directed to: Wage and Hours of Employees on Public Works, Chapter 104, Hawaii Revised Statutes (HRS); Hawaii Public Procurement Code, Authority to debar or suspend, Section 103D-702, HRS; Hawaii Employment Relations Act, Chapter 377, HRS; Hawaii Employment Security Law, Chapter 383, HRS; Worker's Compensation Law, Chapter 386, HRS; Wage and Hour Law, Chapter 387, HRS; Occupational Safety and Health, Chapter 396, HRS; and Authority to Debar or Suspend, Chapter 126, subchapter 2, Hawaii Administrative Rules (HAR).

7.15 PATENTED DEVICES, MATERIALS AND PROCESSES - If the Contractor desires to use any design, device, material, or process covered by letters of patent or copyright, the right for such use shall be procured by the Contractor from the patentee or owner. The Contractor shall defend, protect, indemnify and hold harmless the State and its Departments and Agencies, any affected third party, or political subdivision from any and all claims for infringement by reason of the use of any such patented design, device, material or process, or any trademark or copyright in connection with the work to be performed under the contract, shall defend, protect, indemnify and hold harmless the State and its Departments and Agencies for any costs, expenses and damages which it may be obligated to pay by reason of any such infringement at any time during the prosecution or after the completion of the work. This section shall not apply to any design, device, material or process covered by letters of patent or copyright, which the Contractor is required to use by the drawings or specifications.

7.16 SANITARY, HEALTH AND SAFETY PROVISIONS

7.16.1 The Contractor shall provide and maintain in a neat, sanitary condition such accommodations for the use of its employees as may be necessary to comply with the requirements of the State and local Boards of Health, or other bodies or tribunals having jurisdiction. Unless otherwise stated in the drawings or specifications, the Contractor shall install toilet facilities conveniently located at the job site and maintain same in a neat and sanitary condition for the use of the employees on the job site for the duration of the contract. The toilet facilities shall conform to the requirements of the State Department of Health. The cost of installing, maintaining and removing the toilet facilities shall be considered incidental to and paid for under various contract pay items for work or under the lump sum bids as the case may be, and no additional compensation will be made therefore. These requirements shall not modify or abrogate in any way the requirements or regulations of the State Department of Health.

7.16.2 Attention is directed to Federal, State and local laws, rules and regulations concerning construction safety and health standards. The Contractor shall not require any worker to work in surroundings or under conditions which are unsanitary, hazardous or dangerous to their health or safety.

7.17 PROTECTION OF PERSONS AND PROPERTY

7.17.1 Safety Precautions and Programs - The Contractor shall be responsible for initiating, maintaining and supervising all safety precautions and programs in connection with the performance of the Contract. The Contractor shall take reasonable precautions for the safety of, and shall provide reasonable protection to prevent damage, injury or loss to:

7.17.1.1 All persons on the Work site or who may be affected by the Work;

7.17.1.2 All the Work and materials and equipment to be incorporated therein, whether in storage on or off the site, under care, custody or control of the Contractor and its subcontractors; and

7.17.1.3 Other property at the site or adjacent thereto, including trees, shrubs lawns walks pavement, roadways structures, and utilities not designated for removal, relocation or replacement in the course of construction.

7.17.2 Contractor shall give notices and comply with applicable laws, ordinances, regulations, rules, and lawful orders of any public body having jurisdiction for the safety of persons or property or their protection from damage, injury or loss; and the Contractor shall erect and

maintain reasonable safeguards for safety and protection, including posting danger signs, or other warnings against hazards.

7.17.3 The Contractor shall notify Owners of adjacent properties and of underground (or overhead) utilities when performing work, which may affect the Owners; and shall cooperate with the Owners in the protection, removal and replacement of their property.

7.17.4 All damage, injury or loss to any property referred to in paragraphs 7.17.1.2 and 7.17.1.3 caused by the fault or negligence or damage or loss attributable to acts or omissions directly or indirectly in whole or part by the Contractor a subcontractor or any one directly or indirectly employed by them, or by anyone for whose acts they might be liable, shall be remedied promptly by the Contractor.

7.17.5 The Contractor shall designate a responsible member of the Contractor's organization at the site whose duty shall be the protection of accidents. This person shall be the Contractor's superintendent unless otherwise designated by the Contractor

7.17.6 The Contractor shall not load or permit any part of the construction to be loaded so as to endanger its safety. The Contractor shall not injure or destroy trees or shrubs nor remove or cut them without permission of the Engineer. Contractor shall protect all land monuments and property marks until an authorized agent has witnessed or otherwise referenced their location and shall not remove them until directed.

7.17.7 In the event the Contractor encounters on the site, material reasonably believed to be asbestos or other hazard material that has not been rendered harmless, the Contractor shall stop work in the area and notify the Engineer promptly. The work in the affected area shall be resumed in the absence of hazard materials or when the hazard has been rendered harmless.

7.17.8 Emergencies - In an emergency affecting the safety and protection of persons or the Work or property at the site or adjacent thereto, Contractor without special instructions or authorization from the Engineer, shall act, at the Contractor's discretion, to prevent threatened damage, injury or loss. Contractor shall give the Engineer prompt written notice of the emergency and actions taken. Additional compensation or extension of time claimed by the Contractor on account of an emergency shall be determined under the provisions of Section 7.25 DISPUTES AND CLAIMS.

7.18 ARCHAEOLOGICAL SITES

7.18.1 Should historic sites such as walls, platforms, pavements and mounds, or remains such as artifacts, burials, concentration of charcoal or shells be encountered

during construction, work shall cease in the immediate vicinity of the find and the find shall be protected from further damage. The Contractor shall immediately notify the Engineer and contact the State Historic Preservation Division which will assess the significance of the find and recommend the appropriate mitigation measures, if necessary.

7.18.2 When required, the Contractor shall provide and install any temporary fencing as shown on the drawings to protect archaeological sites within the project. The fencing shall be installed prior to any construction activity and shall be maintained by the Contractor for the duration of the project. Fence installation and maintenance shall be to the satisfaction of the Engineer. The Contractor shall remove the fencing upon completion of construction, or as directed by the Engineer.

7.18.3 No work shall be done within the temporary fencing area. If any construction work is done within the temporary fencing, the Contractor shall notify the Engineer immediately; and if the Contractor entered the archaeological site area without permission, it shall stop work in this area immediately. The Engineer shall notify the archaeologist to assess any damage to the area. The Contractor shall allow the archaeologist sufficient time to perform the field investigation.

7.18.4 Any site requiring data recovery within the project shall not be disturbed until data recovery is completed.

7.19 RESPONSIBILITY FOR DAMAGE CLAIMS; INDEMNITY

7.19.1 The Contractor shall indemnify the State and the Department against all loss of or damage to the State's or the Department's existing property and facilities arising out of any act or omission committed in the performance of the work by the Contractor, any subcontractor or their employees and agents. Contractor shall defend, hold harmless and indemnify the Department and the State, their employees, officers and agents against all losses, claims, suits, liability and expense, including but not limited to attorneys' fees, arising out of injury to or death of persons (including employees of the State and the Department, the Contractor or any subcontractor) or damage to property resulting from or in connection with performance of the work and not caused solely by the negligence of the State or the Department, their agents, officers and employees. The State or the Department may participate in the defense of any claim or suit without relieving the Contractor of any obligation hereunder. The purchase of liability insurance shall not relieve the Contractor of the obligations described herein.

7.19.2 The Contractor agrees that it will not attempt to hold the State and its Departments and Agencies and their officers, representatives, employees or agents, liable or

responsible for any losses or damages to third parties from the action of the elements, the nature of the work to be done under these GENERAL CONDITIONS or from any unforeseen obstructions, acts of God, vandalism, fires or encumbrances which may be encountered in the prosecution of the work.

7.19.3 The Contractor shall pay all just claims for materials, supplies, tools, labor and other just claims against the Contractor or any subcontractor in connection with this contract and the surety bond will not be released by final acceptance and payment by the Department unless all such claims are paid or released. The Department may, but is not obligated to, withhold or retain as much of the monies due or to become due the Contractor under this contract considered necessary by the Engineer to cover such just claims until satisfactory proof of payment or the establishment of a payment plan is presented.

7.19.4 The Contractor shall defend, indemnify and hold harmless the State and its Departments and Agencies and their officers, representatives, employees or agents from all suits, actions or claims of any character brought on account of any claims or amounts arising out of or recovered under the Workers' Compensation Laws or violation of any other law, by-law, ordinance, order or decree.

7.20 CHARACTER OF WORKERS OR EQUIPMENT

7.20.1 The Contractor shall at all times provide adequate supervision and sufficient labor and equipment for prosecuting the work to full completion in the manner and within the time required by the contract.

7.20.2 Character and Proficiency of Workers - All workers shall possess the proper license and / or certification, job classification, skill and experience necessary to properly perform the work assigned to them. All workmen engaged in special work or skilled work such as bituminous courses or mixtures, concrete pavement or structures, electrical installation, plumbing installation, or in any trade shall have sufficient experience in such work and in the operation of the equipment required to properly and satisfactorily perform all work. All workers shall make due and proper effort to execute the work in the manner prescribed in these GENERAL CONDITIONS, otherwise, the Engineer may take action as prescribed herein.

7.20.2.1 Any worker employed on the project by the Contractor or by any subcontractor who, in the opinion of the Engineer, is not careful and competent, does not perform its work in a proper and skillful manner or is disrespectful, intemperate, disorderly or neglects or refuses to comply with directions given, or is otherwise objectionable shall at the written request of the Engineer,

be removed forthwith by the Contractor or subcontractor employing such worker and shall not be employed again in any portion of the work without the written consent of the Engineer. Should the Contractor or subcontractor continue to employ, or again employ such person or persons on the project, the Engineer may withhold all payments which are or may become due, or the Engineer may suspend the work until the Engineer's orders are followed, or both.

7.20.3 Insufficient Workers - A sufficient number of workers shall be present to ensure the work is accomplished at an acceptable rate. In addition, the proper ratio of apprentice to journey worker shall be maintained to ensure the work is properly supervised and performed. In the event that the Engineer finds insufficient workers are present to accomplish the work at an acceptable rate of progress or if a adequate number of journey workers are not present and no corrective action is taken by the Contractor after being informed in writing, the Engineer may terminate the contract as provided for under Section 7.27 TERMINATION OF CONTRACT FOR CAUSE.

7.20.4 Equipment Requirements - All equipment furnished by the Contractor and used on the work shall be of such size and of such mechanical condition that the work can be performed in an acceptable manner at a satisfactory rate of progress and the quality of work produced will be satisfactory.

7.20.4.1 Equipment used on any portion of the project shall be such that no injury to the work, persons at or near the site, adjacent property or other objects will result from its use.

7.20.4.2 If the Contractor fails to provide adequate equipment for the work, the contract may be terminated as provided under Section 7.27 TERMINATION OF CONTRACT FOR CAUSE.

7.20.4.3 In the event that the Contractor furnishes and operates equipment on a force-account basis, it shall be operated to obtain maximum production under the prevailing conditions.

7.21 CONTRACT TIME

7.21.1 Time is of the essence for this contract.

7.21.2 Calculation of Contract Time - When the contract time is on a working day basis, the total contract time allowed for the performance of the work shall be the number of working days shown in the contract plus any additional working days authorized in writing as provided hereinafter. Refer to Article 1 DEFINITIONS for the definition of Working Day. The count of elapsed working days to be charged against contract time shall begin from the date of Notice to Proceed and shall continue consecutively to the date of Project Acceptance

determined by the Engineer. When the contract completion time is a fixed calendar date, it shall be the date on which all work on the project shall be completed.

Maintenance periods are not included within the contract time unless specifically noted in the Contract Documents.

7.21.3 Modifications of Contract Time §3-125-4 HAR

7.21.3.1 Extensions - For increases in the scope for work caused by alterations and additional work made under Section 4.2 CHANGES, the Contractor will be granted a time extension only if the changes increase the time of performance for the Contract. If the Contractor believes that an extension of time is justified and is not adequately provided for in a Field Order, it must request the additional time sought in writing when the detailed cost breakdown required by Section 4.2 CHANGES, is submitted. The Contractor must show how the time of performance for the critical path will be affected and must also support the time extension request with schedules and statements from its subcontractors, suppliers, and/or manufacturers. Compensation for any altered or additional work will be paid as provided in Section 4.2 CHANGES.

7.21.3.2 The Department may direct changes to the work at any time until the work is finally accepted. The issuance of a Field Order at any time may alter or modify the contract duration only by the days specified therein; or if not specified therein, for the days the critical path must be extended for the change. Additional time to perform the extra work will be added to the time allowed in the contract without regard to the date the change directive was issued, even if the contract completion date has passed. A change requiring time will not constitute a waiver of pre-existing Contractor delay.

7.21.4 Delay for Permits - For delays beyond the control of the Contractor in obtaining necessary permits, one day extension for each day delay may be granted by the Engineer, provided the Contractor notifies the Engineer that the permits are not available, as soon as the delay occurs. Time extensions shall be the exclusive relief granted on account of such delays. No additional compensation will be paid for these time extensions.

7.21.5 Delays Beyond Contractor's Control
§3-125-18(4) - For delays affecting the critical path caused by acts of God, or the public enemy, fire, unusually severe weather, earthquakes, floods, epidemics, quarantine restrictions, labor disputes, freight embargoes and other reasons beyond the Contractor's control, the Contractor may be granted an extension of time provided that:

7.21.5.1 The Contractor notifies the Engineer in writing within five (5) work days after the occurrence of the

circumstances described above and states the possible effects on the completion date of the contract.

7.21.5.2 No time extension will be granted for weather conditions other than unusually severe weather occurrences, and floods.

7.21.5.3 The Contractor, if requested, submits to the Engineer within ten (10) work days after the request, a written statement describing the delay to the project. The extent of delay must be substantiated as follows:

- (a) State specifically the reason or reasons for the delay and fully explain in a detailed chronology the effect of this delay to the work and/or the completion date.
- (b) Submit copies of purchase order, delivery tag, and any other pertinent documentation to support the time extension request.
- (c) Cite the period of delay and the time extension requested.
- (d) A statement either that the above circumstances have been cleared and normal working conditions restored as of a certain day or that the above circumstances will continue to prevent completion of the project.

7.21.5.4 Time extensions shall be the exclusive relief granted and no additional compensation will be paid the Contractor for such delays.

7.21.6 Delays in Delivery of Materials - For delays in delivery of materials and / or equipment which occur as a result of unforeseeable causes beyond the control and without fault or negligence of both the Contractor, its subcontractor(s) or supplier(s), the Contractor may be granted an extension of time provided that it complies with the following procedures.

7.21.6.1 The Contractor must notify the Engineer in writing within five (5) consecutive working days after it first has any knowledge of delays or anticipated delays and state the effects such delays may have on the completion date of the contract.

7.21.6.2 The Contractor, if requested, must submit to the Engineer within ten (10) working days after a firm delivery date for the material and equipment is established, a written statement as to the delay to the progress of the project. The delay must be substantiated as follows:

- (a) State specifically the reason or reasons for the delay. Explain in a detailed chronology the effect of this delay to the other work and / or the completion date.
- (b) Submit copies of purchase order(s), factory invoice(s), bill(s) of lading, shipping manifest(s),

delivery tag(s) and any other pertinent correspondence to support the time extension request.

(c) Cite the start and end date of the delay and the days requested therefore. The delay shall not exceed the difference between the originally scheduled delivery date versus the actual delivery date.

7.21.6.3 Time extensions shall be the exclusive relief granted and no additional compensation will be paid the Contractor on account of such delay.

7.21.7 Delays For Suspension of Work - Delay during periods of suspension of the work by the Engineer shall be computed as follows:

7.21.7.1 When the performance of the work is totally suspended for one or more days (calendar or working days, as appropriate) by order of the Engineer in accordance with paragraphs 7.24.1.1, 7.24.1.2, 7.24.1.4 or 7.24.1.6 the number of days from the effective date of the Engineer's order to suspend operations to the effective date of the Engineer's order to resume operations shall not be counted as contract time and the contract completion date will be adjusted. Should the Contractor claim for additional days in excess of the suspension period, Contractor shall provide evidence justifying the additional time. During periods of partial suspensions of the work, the Contractor will be granted a time extension only if the partial suspension affects the critical path. If the Contractor believes that an extension of time is justified for a partial suspension of work, it must request the extension in writing at least five (5) working days before the partial suspension will affect the critical operation(s) in progress. The Contractor must show how the critical path was increased based on the status of the work and must also support its claim, if requested, with statements from its subcontractors. A suspension of work will not constitute a waiver of pre-existing Contractor delay.

7.21.8 Contractor Caused Delays - No time extension will be considered for the following:

7.21.8.1 Delays in performing the work caused by the Contractor, subcontractor and / or supplier.

7.21.8.2 Delays in arrival of materials and equipment caused by the Contractor, subcontractor and / or supplier in ordering, fabricating, delivery, etc.

7.21.8.3 Delays requested for changes which the Engineer determines unjustifiable due to the lack of supporting evidence or because the change is not on the critical path.

7.21.8.4 Delays caused by the failure of the Contractor to submit for review and acceptance by the Engineer, on a timely basis, shop drawings, descriptive sheets, material

samples, color samples, etc. except as covered in subsection 7.21.5 and 7.21.6.

7.21.8.5 Failure to follow the procedure within the time allowed to qualify for a time extension.

7.21.8.6 Days the Contractor is unable to work due to normal rainfall or other normal bad weather day conditions.

7.21.9 Reduction in Time - If the Department deletes any portion of the work, an appropriate reduction of contract time may be made in accordance with Section 4.2 CHANGES.

7.22 CONSTRUCTION SCHEDULE

7.22.1 The Contractor shall submit its detailed construction schedule to the Engineer prior to the start of the work. The purpose of the schedule is to allow the Engineer to monitor the Contractor's progress on the work. The schedule shall account for normal inclement weather, unusual soil or other conditions that may influence the progress of the work, schedules and coordination required by any utility, off or on site fabrications, and all other pertinent factors that relate to progress.

7.22.2 Submittal of and the Engineer's receipt of the construction schedule shall not imply the Department's approval of the schedule's breakdown, its individual elements, and any critical path that may be shown. Any acceptance or approval of the schedule 1) shall be for general format only and not for sequences or durations thereon, and 2) shall not be deemed an agreement by the Department that the construction means, methods and resources shown on the schedule will result in work that conforms to the contract requirements. The Contractor has the risk of all elements (whether or not shown) of the schedule and its execution. Additional compensation shall not be due the Contractor in the event that deviations from the Contractor's schedule, caused by any design revisions required to resolve site conditions or State, County, or utility requirements, affect the efficiency of its operations.

7.22.3 In the event the Contractor submits and the Department receives an accelerated schedule (shorter than the contract time), such will not constitute an agreement to modify the contract time or completion date, nor will the receipt, acceptance or approval of such a schedule incur any obligation by the Department.

7.22.4 Caution - The Department will not be responsible if the Contractor does not meet its accelerated schedule.

7.22.5 The requirements of this Section 7.22 CONSTRUCTION SCHEDULE may be waived by the Engineer.

7.23 STATEMENT OF WORKING DAYS - For all contracts on a working day basis, the Contractor will submit a statement of the number of working days for each month together with the Monthly Payment Application. The Monthly Payment Application will not be processed without the statement of working days.

7.24 SUSPENSION OF WORK §3-125-7 HAR

7.24.1 Procedure to be followed - The Engineer may, by written order, suspend the performance of the Work up to thirty (30) days and the Engineer, for an unlimited number of days, either in whole or in part for any cause, including but not limited to:

7.24.1.1 Weather or excess bad weather days, considered unsuitable by the Engineer for prosecution of the work; or

7.24.1.2 Soil Conditions considered unsuitable by the Engineer for prosecution of the work; or

7.24.1.3 Failure of the Contractor to:

(1) Correct conditions unsafe for the general public or for the workers;

(2) Carry out orders given by the Engineer;

(3) Perform the work in strict compliance with the provisions of the contract; or

(4) Provide a qualified Superintendent on the jobsite as described under Section 5.8 COOPERATION BETWEEN THE CONTRACTOR AND THE DEPARTMENT.

7.24.1.4 When any redesign is deemed necessary by the Engineer; or

7.24.1.5 Disturbance due to noise, odors or dust arising from the construction even if such disturbance does not violate the section on Environmental Protection contained in the specifications; or

7.24.1.6 The convenience of the State.

7.24.2 Partial, Total Suspension of Work - Suspension of work on some but not all items of work shall be considered a partial suspension. Suspension of work on the entire work at the job site shall be considered total suspension. The period of suspension shall be computed as set forth in subsection 7.21.7 -Delays for Suspension of Work.

7.24.3 Payment §3-125-7 HAR

7.24.3.1 In the event that the Contractor is ordered by the Engineer in writing as provided herein to suspend all work under the contract in accordance with paragraphs 7.24.1.4 or 7.24.1.6, the Contractor may be reimbursed for actual direct costs incurred on work at the jobsite, as authorized in writing by the Engineer, including costs expended for the protection of the work. Payment for equipment which must standby during such suspension of work shall be made as described in clause 8.3.4.5. (e). No payment will be made for profit on any suspension costs. An allowance of five percent (5%) will be paid on any reimbursed actual costs for indirect categories of delay costs, including extended branch and home-office overhead and delay impact costs.

7.24.3.2 However, no adjustment to the contract amount or time shall be made under this Section 7.24 for any suspension, delay, or interruption:

(a) To the extent that performance would have been so suspended, delayed, or interrupted by any other cause, including the fault or negligence of the Contractor; or

(b) For which an adjustment is provided for or excluded under any other provision of this Contract.

7.24.3.3 Any adjustment in contract price made pursuant to this subsection shall be determined in accordance with this Section 7.24 and Section 4.2 CHANGES.

7.24.3.4 Claims for such compensation shall be filed with the Engineer within ten (10) calendar days after the date of the order to resume work or such claims will be waived by the Contractor. Together with the claim, the Contractor shall submit substantiating documents supporting the entire amount shown on the claim. The Engineer may make such investigations as are deemed necessary and shall be the sole judge of the claim and the Engineer's decision shall be final.

7.24.4 Claims Not Allowed - No claim under this Section 7.24 shall be allowed:

7.24.4.1 For any direct costs incurred more than twenty (20) days before the Contractor shall have notified the Engineer in writing of any suspension that the Contractor considered compensable. This requirement shall not apply as to a claim resulting from a suspension order under paragraphs 7.24.1.4 or 7.24.1.6, and

7.24.4.2 Unless the claim is asserted in writing within ten (10) calendar days after the termination of such suspension, delay, or interruption, but in no case not later than the date of final payment under the contract.

7.24.4.3 No provision of this Section 7.24 shall be construed as entitling the Contractor to compensation for delays due to failure of surety, for suspensions made at the request of the Contractor, for any delay required under

the Contract, for partial suspension of work or for suspensions made by the Engineer under the provisions of paragraphs 7.24.1.1, 7.24.1.2, 7.24.1.3 and 7.24.1.5.

7.25 DISPUTES AND CLAIMS §3-126-31 HAR

7.25.1 Required Notification - As a condition precedent for any claim, the Contractor must give notice in writing to the Engineer in the manner and within the time periods stated in Section 4.2 CHANGES for claims for extra compensation, damages, or an extension of time due for one or more of the following reasons:

7.25.1.1 Requirements not clearly covered in the contract, or not ordered by the Engineer as an extra;

7.25.1.2 Failure by the State and Contractor to agree to an Oral Order or an adjustment in price or contract time for a Field Order or a Change Order issued by the State;

7.25.1.3 An action or omission by the Engineer requiring performance changes beyond the scope of the contract;

7.25.1.4 Failure of the State to issue a Field Order for controversies within the scope of Section 4.2 CHANGES.

7.25.1.5 For any other type of claim, the Contractor shall give notice within the time periods set forth in contract provisions pertaining to that event. If no specific contract provisions pertain to the claim, then the written notice of claim must be submitted within fifteen (15) days of the event giving rise to the claim.

7.25.2 Continued Performance of Work - The Contractor shall at all times continue with performance of the contract in full compliance with the directions of the Engineer. Continued performance by the Contractor shall not be deemed a waiver of any claim for additional compensation, damages, or an extension of time for completion, provided that the written notice of claim is submitted in accordance with subsection 7.25.1

7.25.3 The requirement for timely written notice shall be a condition precedent to the assertion of a claim.

7.25.4 Requirements for Notice of Claim -The notice of claim shall clearly state the Contractor's intention to make claim and the reasons why the Contractor believes that additional compensation, changes or an extension of time may be remedies to which it is entitled. At a minimum, it shall provide the following:

7.25.4.1 Date of the protested order, decision or action;

7.25.4.2 The nature and circumstances which caused the claim;

7.25.4.3 The contract provision that support the claim;

7.25.4.4 The estimated dollar cost, if any, of the protested work and how that estimate was determined; and

7.25.4.5 An analysis of the progress schedule showing the schedule change or disruption if the Contractor is asserting a schedule change or disruption.

7.25.5 If the protest or claim is continuing, the information required in subsection 7.25.4 above shall be supplemented as requested by the Engineer.

7.25.6 Final Statement for Claim - The Contractor shall provide a final written statement of the actual adjustment in contract price and/or contract time requested for each notice of claim. Such statement shall clearly set forth that it is the final statement for that notice of claim. All such final statements shall be submitted within thirty (30) days after completion of the work that is the subject of the claim, but in no event no later than thirty (30) days after the Project Acceptance Date or the date of termination of the Contractor, whichever comes first.

7.25.7 All claims of any nature are barred if asserted after final payment under this contract has been made, except as provided under Section 8.9 CLAIMS ARISING OUT OF PAYMENT FOR REQUIRED WORK.

7.25.8 Contractor may protest the assessment or determination by the Engineer of amounts due the State from the Contractor by providing a written notice to the Engineer within thirty (30) days of the date of the Engineer's written assessment or determination. Said notice shall comply with all requirements of subsections 7.25.4 and 7.25.6 above. The requirement of such notice cannot be waived and it is a condition precedent to any claim by the Contractor. Failure to comply with these notice provisions constitutes a waiver of any claim.

7.25.9 In addition to the requirements of subsections 7.25.4, 7.25.6, and 7.25.8, all final written statements of claim shall be certified. This certification requirement applies to the Contractor without exception, including, but not limited to, situations involving "pass through" claims of subcontractors or suppliers. The certification must be executed by a person duly authorized to bind the Contractor with respect to the claim. The certification shall state as follows:

7.25.9.1 "I certify that the claim is made in good faith; that the supporting data are accurate and complete to the best of my knowledge and belief; that the amount requested accurately reflects the contract adjustment for which the Contractor believes the State is liable; and that I am duly authorized to certify the claim on behalf of the Contractor."

7.25.10 Decision on Claim / Appeal - The Contracting Officer shall decide all controversies between the State and the contractor which arise under, or are by virtue of,

this contract and which are not resolved by mutual agreement. The decision of the Contracting Officer on the claim shall be final and conclusive, unless fraudulent or unless the contractor delivers to the Adjutant General a written appeal of the Contracting Officer's decision no later than 30 days after the date of the Contracting Officers decision. The Adjutant General's decision shall be final and conclusive, unless fraudulent or unless the contractor brings an action seeking judicial review of the Adjutant General's decision in an appropriate circuit court of this State within six months from the date of the Adjutant General's decision.

7.25.10.1 If the contractor delivers a written request for a final decision concerning the controversy, the Adjutant General shall issue a final decision within 90 days after receipt of such a request; provided that if the Adjutant General does not issue a written decision within 90 days or within such longer period as may be agreed upon by the parties, then the contractor may proceed as if an adverse decision had been received. Both parties to this contract agree that the period of up to 30 days to appeal the Contracting Officer's decision to the Adjutant General shall not be included in the 90 day period to issue a final decision.

7.25.11 Payment and Interest - The amount determined payable pursuant to the decision, less any portion already paid, normally should be paid without awaiting Contractor action concerning appeal. Such payments shall be without prejudice to the rights of either party. Interest on amounts ultimately determined to be due to a Contractor shall be payable at the Statutory rate applicable to judgments against the State under Chapter 662, HRS from the date of receipt of a properly certified final written statement of actual adjustment required until the date of decision; except, however, that if an action is initiated in circuit court, interest under this Section 7.25 shall only be calculated until the time such action is initiated. Interest on amounts due the State from the Contractor shall be payable at the same rate from the date of issuance of the Engineer's notice to the Contractor. Where such payments are required to be returned by a subsequent decision, interest on such payments shall be paid at the statutory rate from the date of payment.

7.25.12 Contractor shall comply with any decision of the Engineer and proceed diligently with performance of this contract pending final resolution by a circuit court of this State of any controversy arising under, or by virtue of, this contract, except where there has been a material breach of contract by the State; provided that in any event the Contractor shall proceed diligently with the performance of the contract where the Engineer has made a written determination that continuation of work under the contract is essential to the public health and safety.

7.26 FAILURE TO COMPLETE THE WORK ON TIME

7.26.1 Completion of the work within the required time is important because delay in the prosecution of the work will inconvenience the public and interfere with the State's business. In addition, the State will be damaged by the inability to obtain full use of the completed work and by increased engineering, inspection, superintendence, and administrative services in connection with the work. Furthermore, delay may detrimentally impact the financing, planning, or completion of other State projects because of the need to devote State resources to the project after the required completion date. The monetary amount of such public inconvenience, interference with State business, and damages, is difficult, if not impossible, to accurately determine and precisely prove. Therefore, it is hereby agreed that the amount of such damages shall be the appropriate sum of liquidated damages as set forth below.

7.26.1.1 When the Contractor fails to complete the Work or any portion of the Work within the time or times fixed in the contract or any extension thereof, it is agreed the Contractor shall pay liquidated damages to the Department based upon the amount stated in the Offer form.

7.26.1.2 If the Contractor fails to correct Punch list deficiencies as required by Section 7.32 PROJECT ACCEPTANCE DATE, the State will be inconvenienced and damaged, therefore, it is agreed that the Contractor shall pay liquidated damages to the Department based upon the amount stated in the Offer Form. Liquidated damages shall accrue for all days after the Contract Completion Date or any extension thereof until the date the Punchlist items are corrected and accepted by the Engineer.

7.26.1.3 If the Contractor fails to submit final documents as required by Section 7.33 FINAL SETTLEMENT OF THE CONTRACT, the State will be inconvenienced and damaged, therefore, it is agreed that the Contractor shall pay liquidated damages to the Department based upon the amount stated in the Offer Form. Liquidated damages shall accrue for all days after the Contract Completion Date or any extension thereof, until the date the final documents are received by the Engineer.

7.26.1.4 The Engineer shall assess the total amount of liquidated damages in accordance with the amount stated in the Offer Form and provide written notice of such assessment to the Contractor.

7.26.2 Acceptance of Liquidated Damages -The assessment of liquidated damages by the Engineer shall be accepted by the parties hereto as final, unless the Contractor delivers a written appeal of the Engineer's decision in accordance with subsection 7.25.10 requirements. Any allowance of time or remission of

charges or liquidated damages shall in no other manner affect the rights or obligations of the parties under this contract nor be construed to prevent action under Section 7.27 TERMINATION OF CONTRACT FOR CAUSE. If the Department terminates the Contractor's right to proceed, the resulting damage will include such liquidated damages for such time as may be required for final completion of the work after the required contract completion date.

7.26.3 Payments for Liquidated Damages -Liquidated damages shall be deducted from monies due or that may become due to the Contractor under the contract or from other monies that may be due or become due to the Contractor from the State.

7.27 TERMINATION OF CONTRACT FOR CAUSE §3-125-18 HAR

7.27.1 Default - If the Contractor refuses or fails to perform the work, or any separable part thereof, with such diligence as will assure its completion within the time specified in this contract, or any extension thereof, fails to complete the work within such time, or commits any other material breach of this contract, and further fails within seven (7) days after receipt of written notice from the Engineer to commence and continue correction of the refusal or failure with diligence and promptness, the Engineer may, by written notice to the Contractor, declare the Contractor in breach and terminate the Contractor's right to proceed with the work or the part of the work as to which there has been delay or other breach of contract.

In such event, the Department may take over the work and perform the same to completion, by contract or otherwise, and may take possession of, and utilize in completing the work, the materials, appliances, and plant as may be on the site of the work and necessary therefore.

Whether or not the Contractor's right to proceed with the work is terminated, the Contractor and the Contractor's sureties shall be liable for any damage to the Department resulting from the Contractor's refusal or failure to complete the work within the specified time.

7.27.2 Additional Rights and Remedies - The rights and remedies of the Department provided in this contract are in addition to any other rights and remedies provided by law.

7.27.3 Costs and Charges

7.27.3.1 All costs and charges incurred by the Department, together with the cost of completing the work under contract, will be deducted from any monies due or which would or might have become due to the Contractor had it been allowed to complete the work under the contract. If such expense exceeds the sum which would have been payable under the contract, then the Contractor and the surety shall be liable and shall pay the Department the amount of the excess.

7.27.3.2 In case of termination, the Engineer shall limit any payment to the Contractor to the part of the contract satisfactorily completed at the time of termination. Payment will not be made until the work has satisfactorily been completed and the tax clearance required by Section 8.8 FINAL PAYMENT is submitted by the Contractor. Termination shall not relieve the Contractor or Surety from liability for performance liquidated damages.

7.27.4 Erroneous Termination for Cause - If, after notice of termination of the Contractor's right to proceed under this Section 7.27, it is determined for any reason that good cause did not exist to allow the Department to terminate as provided herein, the rights and obligations of the parties shall be the same as, and the relief afforded the Contractor shall be limited to, the provisions contained in Section 7.28 TERMINATION FOR CONVENIENCE.

7.28 TERMINATION FOR CONVENIENCE §3-125-22 HAR

7.28.1 Termination - The Engineer may, when the interests of the State so require, terminate this contract in whole or in part, for the convenience of the State. The Engineer shall give written notice of the termination to the Contractor specifying the part of the contract terminated and when termination becomes effective.

7.28.2 Contractor's Obligations - The Contractor shall incur no further obligations in connection with the terminated work and on the date set in the notice of termination the Contractor will stop work to the extent specified. The Contractor shall also terminate outstanding orders and subcontracts as they relate to the terminated work. The Contractor shall settle the liabilities and claims arising out of the termination of subcontracts and orders connected with the terminated work subject to the State's approval. The Engineer may direct the Contractor to assign the Contractor's right, title, and interest under terminated orders or subcontracts to the State. The Contractor must still complete the work not terminated by the notice of termination.

7.28.3 Right to Construction and Goods - The Engineer may require the Contractor to transfer title and delivery to the State in the manner and to the extent directed by the Engineer, the following:

7.28.3.1 Any completed work; and

7.28.3.2 Any partially completed construction, goods, materials, parts, tools, dies, jigs, fixtures, drawings, information, and contract rights (hereinafter called "construction material") that the Contractor has specifically produced or specially acquired for the performance of the terminated part of this contract.

7.28.3.3 The Contractor shall protect and preserve all property in the possession of the Contractor in which the State has an interest. If the Engineer does not elect to retain any such property, the Contractor shall use its best efforts to sell such property and construction material for the Department's account in accordance with the standards of section 490:2-706, HRS.

7.28.4 Compensation

7.28.4.1 Contractor shall submit a termination claim specifying the amounts due because of the termination for convenience together with cost or pricing data, submitted to the extent required by subchapter 15, chapter 3-122, HAR. If the Contractor fails to file a termination claim within one year from the effective date of termination, the Engineer may pay the Contractor, if at all, an amount set in accordance with paragraph 7.28.4.3.

7.28.4.2 The Engineer and the Contractor may agree to a settlement provided the Contractor has filed a termination claim supported by cost or pricing data submitted as required and that the settlement does not exceed the total contract price plus settlement costs reduced by payments previously made by the State, the proceeds of any sales of construction, supplies, and construction materials under paragraph 7.28.3.3 of this Section, and the contract price of the work not terminated.

7.28.4.3 Absent complete agreement, the Engineer shall pay the Contractor the following amounts, less any payments previously made under the contract.

(a) The cost of all contract work performed prior to the effective date of the notice of termination work plus a five percent (5%) markup on the actual direct costs, including amounts paid to subcontractor, less amounts previously paid or to be paid for completed portions of such work; provided, however, that if it appears that the Contractor would have sustained a loss if the entire contract would have been completed, no markup shall be allowed or included and the amount of compensation shall be reduced to reflect the anticipated rate of loss. No anticipated profit or consequential damage will be due or paid.

(b) Subcontractors shall be paid a markup of ten percent (10%) on their direct job costs incurred to the date of termination. No anticipated profit or consequential damage will be due or paid to any subcontractor. These costs must not include payments made to the Contractor for subcontract work during the contract period.

(c) In any case, the total sum to be paid the Contractor shall not exceed the total contract price reduced by the amount of any sales of construction supplies, and construction materials.

7.28.4.4 Costs claimed, agreed to, or established by the State shall be in accordance with chapter 3-123, HAR.

7.29 CORRECTING DEFECTS - If the Contractor fails to commence to correct any defects of any nature, within ten (10) working days after the correction thereof has been requested in writing by the State, and thereafter to expeditiously complete the correction of said defects, the Engineer may without further notice to the Contractor or surety and without termination of contract, correct the defects and deduct the cost thereof from the contract price.

7.30 FINAL CLEANING - Before final inspection of the work, the Contractor shall clean all ground occupied by the Contractor in connection with the Work of all rubbish, excess materials, temporary structures and equipment, and all parts of the work must be left in a neat and presentable condition to the satisfaction of the Engineer. However, the Contractor shall not remove any warning and directional signs prior to the formal acceptance by the Engineer. Full compensation for final cleaning will be included in the prices paid for the various items of work or lump sum bid, as the case may be, and no separate payment will be made therefore.

7.31 SUBSTANTIAL COMPLETION, AND FINAL INSPECTION - Before the Department accepts the project as being completed, unless otherwise stipulated by the Engineer, the following procedure shall be followed:

7.31.1 Substantial Completion:

7.31.1.1 The Contractor and its subcontractors shall inspect the project to confirm whether the Project is Substantially Complete. This inspection effort shall include the testing of all equipment and providing a Punch list that identifies deficiencies which must be corrected. Contractor shall make the corrections and if required repeat the procedure. Also, the Contractor shall schedule final Building, Plumbing, Electrical, Elevator, Fire and other required inspections and obtain final approvals.

(a) When in compliance with the above requirements, the Contractor shall notify the Engineer in writing that project is Substantially Complete and ready for a Final Inspection. Along with the Substantial Completion notification, the Contractor shall provide its Punch list(s) with the status of the deficiencies and dates when the deficiencies were corrected. The Project Inspector and / or the Engineer shall make a preliminary determination whether project is Substantially Complete.

(b) If the Project is not Substantially Complete, the Engineer shall inform the Contractor. The Contractor shall identify deficiencies which must be corrected, update its Punch list, make the necessary corrections and repeat the previous step. After completing the necessary work, the Contractor shall notify the Engineer in writing

that Punch list deficiencies have been corrected and the project is ready for a Final Inspection.

(c) If the Project is Substantially Complete, the Engineer shall schedule a Final Inspection within fifteen (15) days of the Contractor's notification letter or as otherwise determined by the Engineer.

7.31.1.2 In addition, and to facilitate closing of the project, the Contractor shall also proceed to obtain the following closing documents (where applicable) prior to the Final Inspection:

- (1) Field-Posted As-Built Drawings.
- (2) Maintenance Service Contract and two (2) copies of a list of all equipment.
- (3) Operating and maintenance manuals.
- (4) Air conditioning test and balance reports.
- (5) Any other final submittal required by the technical sections of the contract.

7.31.2 Final Inspection: If at the Final Inspection the Engineer determines that all work is completed, the Engineer shall notify the Contractor in accordance with Section 7.32 PROJECT ACCEPTANCE DATE. Should there be remaining deficiencies which must be corrected, the Contractor shall provide an updated Punch list to the Engineer, within five (5) days from the Final Inspection Date. The Contractor shall make the necessary corrections.

7.31.2.1 The Engineer shall confirm the list of deficiencies noted by the Contractor's punch list(s) and will notify the Contractor of any other deficiencies that must be corrected before final settlement.

7.31.3 The Engineer may add to or otherwise modify the Punch list from time to time. The Contractor shall take immediate action to correct the deficiencies.

7.31.4 Revoking Substantial Completion - At any time before final Project Acceptance is issued, the Engineer may revoke the determination of Substantial Completion if the Engineer finds it was not warranted. The Engineer shall notify the Contractor in writing with the reasons and outstanding deficiencies negating the declaration. Once notified, the Contractor shall make the necessary corrections and repeat the required steps noted in subsections 7.31.1 and 7.31.2.

7.32 PROJECT ACCEPTANCE DATE

7.32.1 If upon Final Inspection, the Engineer finds that the project has been satisfactorily completed in compliance with the contract, the Engineer shall declare

the project completed and accepted and will notify the Contractor in writing of the acceptance by way of the Project Acceptance Notice.

7.32.2 Protection and Maintenance - After the Project Acceptance Date, the Contractor shall be relieved of maintaining and protecting the work EXCEPT that this does not hold true for those portions of the work which have not been accepted, including Punch list deficiencies. The State shall be responsible for the protection and maintenance of the accepted facility.

7.32.3 The date of Project Acceptance shall determine:

7.32.3.1 End of Contract Time.

7.32.3.2 Commencement of all guaranty periods except as noted in Section 7.34 CONTRACTOR'S RESPONSIBILITY FOR WORK: RISK OF LOSS.

7.32.3.3 Commencement of all maintenance services except as noted in Section 7.34 CONTRACTOR'S RESPONSIBILITY FOR WORK: RISK OF LOSS.

7.32.4 Punch list Requirements - If a Punch list is required under Section 7.31 SUBSTANTIAL COMPLETION AND FINAL INSPECTION, the Project Acceptance Notice will include the Engineer's Punch list and the date when correction of the deficiencies must be completed.

7.32.4.1 Punch list corrective work shall be completed prior to Contract Completion Date, or extension thereof.

7.32.5 Upon receiving the Punch list, the Contractor shall promptly devote the required time, labor, equipment, materials and incidentals necessary to correct the deficiencies expeditiously.

7.32.6 For those items of work that cannot be completed by the established date, the Contractor shall submit a schedule in writing to the Engineer for approval along with documentation to justify the time required, no later than five (5) working days before the date stipulated for completion of the Punch list work. A Proposed schedule submitted after the five (5) day period will not be considered.

7.32.7 Failure to Correct Deficiencies - If the Contractor fails to correct the deficiencies within the time established in paragraph 7.32.4.1, the Contracting Officer shall assess liquidated damages as required by Section 7.26 - FAILURE TO COMPLETE THE WORK ON TIME.

7.32.8 If the Contractor fails to correct the deficiencies and complete the work by the established or agreed to date, the State also reserves the right to correct the

deficiencies by whatever method it deems necessary and deduct the cost from the final payment due the contractor.

7.32.9 The Contractor may further be prohibited from bidding in accordance with Section 2.12 - DISQUALIFICATION OF BIDDERS. In addition, assessment of damages shall not prevent action under Section 7.27 - TERMINATION OF CONTRACT FOR CAUSE.

7.33 FINAL SETTLEMENT OF CONTRACT -

The contract will be considered settled after the project acceptance date and when the following items have been satisfactorily submitted, where applicable:

7.33.1 Necessary Submissions in addition to the items noted under paragraph 7.31.1.2.

7.33.1.1 All written guarantees required by the contract.

7.33.1.2 Complete and certified weekly payrolls for the Contractor and its Subcontractor(s).

7.33.1.3 Certificate of Plumbing and Electrical Inspection.

7.33.1.4 Certificate of Building Occupancy.

7.33.1.5 Certificates for Soil Treatment and Wood Treatment.

7.33.1.6 Certificate of Water System Chlorination.

7.33.1.7 Certificate of Elevator Inspection, Boiler and Pressure Pipe installation.

7.33.1.8 All other documents required by the Contract.

7.33.2 Failure to Submit Closing Documents - The Contractor shall submit the final Payment Application and the above applicable closing documents within sixty (60) days from the date of Project Acceptance or the agreed to Punch list completion date. Should the Contractor fail to comply with these requirements, the Engineer may terminate the Contract for cause. The pertinent provisions of Section 7.27 TERMINATION OF CONTRACT FOR CAUSE shall be applicable.

7.33.3 In addition, should the Contractor fail to furnish final closing documents within the required time period, the Engineer shall assess performance liquidated damages as required by Section 7.26 FAILURE TO COMPLETE THE WORK ON TIME.

7.34 CONTRACTOR'S RESPONSIBILITY FOR WORK; RISK OF LOSS

7.34.1 Until the establishment of the Project Acceptance Date or Beneficial Occupancy whichever is

sooner, the Contractor shall take every necessary precaution against injury or damage to any part of the work caused by the perils insured by an All Risk policy excluding earthquakes and floods, whether arising from the execution or from the non-execution of the work. The Contractor shall rebuild, repair, restore and make good all injuries or damage to any portion of the work occasioned by the perils insured by an All Risk policy before the date of final acceptance and shall bear the risk and expense thereof.

7.34.2 After the Project Acceptance Date or Beneficial Occupancy whichever is sooner, the Contractor shall be relieved of maintaining and protecting the work except for those portions of the work which have not been accepted including Punch list deficiencies.

7.34.3 The risk of damage to the work from any hazard or occurrence that may be covered by a required Property Insurance policy is that of the Contractor, unless such risk of loss is placed elsewhere by express language in the contract documents. No claims for any loss or damage shall be recognized by the Department, nor will any such loss or damage excuse the complete and satisfactory performance of the contract by the Contractor.

7.35 GUARANTEE OF WORK

7.35.1 In addition to any required manufacturers warranties, all work and equipment shall be guaranteed by the Contractor against defects in materials, equipment or workmanship for one year from the Project Acceptance Date or as otherwise specified in the Contract Documents, whichever is earlier.

7.35.2 Repair of Work - If, within any guarantee period, repairs or changes are required in connection with the guaranteed work, which in the opinion of the Engineer is necessary due to materials, equipment or workmanship which are inferior, defective or not in accordance with the terms of the Contract, the Contractor shall within five (5) working days and without expense to the Department commence to:

7.35.2.1 Place in satisfactory condition in every instance all such guaranteed work and correct all defects therein; and

7.35.2.2 Make good and repair or replace to new or pre-existing condition all damages to the building, facility, work or equipment or contents thereof, resulting from such defective materials, equipment or installation thereof.

7.35.3 Manufacturer's and Installer's Guarantee-Whenever a manufacturer's or installer's guarantee on any product specified in the respective Specification sections, exceeds one year, this guarantee shall become part of this contract in addition to the Contractor's guarantee. Contractor shall complete the guarantee forms

in the name of the Department and submit such forms to the manufacturer within such time required to validate the guarantee. Contractor shall submit to the Department a photocopy of the completed guarantee form for the Department's record as evidence that such guarantee form was executed by the manufacturer.

7.35.4 If a defect is discovered during a guarantee period, all repairs and corrections to the defective items when corrected shall again be guaranteed for the original full guarantee period. The guarantee period shall be tolled and suspended for all work affected by the defect. The guarantee period for work affected by the defect shall restart for its remaining duration upon confirmation by the Engineer that the deficiencies have been repaired or remedied.

7.35.5 If guarantee is specified for greater than two (2) years, two (2) years shall prevail except for manufacturer's warranties. Manufacturer's warranties shall remain as specified in their respective Specification sections.

7.35.5.1 However, the number of years specified in the technical specifications shall prevail only if it is stated that the number of years for guarantee supersedes this provision.

7.36 WORK OF AND CHARGES BY UTILITIES

7.36.1 The Contractor shall be responsible for scheduling and coordinating the work with the utility companies and applicable Governmental agencies for permanent service installation and connections or modifications to existing utilities. The Contractor shall make available all portions of the work necessary for the Utility companies to do their work. The Department shall not bear the risk of any damage to the contract work caused by any utility company, and work of repairing such damage and delay costs must be resolved between the Contractor and the utility company and their insurers.

7.36.2 Unless stated as an allowance item to be paid by the Contractor, the Department will pay the utility companies and applicable governmental agencies directly for necessary modifications and connections. Contractor charges for overhead, supervision, coordination, profit, insurance and any other incidental expenses shall be included in the Contractor's Bid whether the utility is paid directly by the Department or by an allowance item in the Contract.

7.37 RIGHT TO AUDIT RECORDS

7.37.1 Pursuant to Section 103D-317 HRS the State, at reasonable times and places, may audit the books and records of a Contractor, prospective contractor, subcontractor and prospective subcontractor relating to

the Contractor's or subcontractor's cost or pricing data. The books and records shall be maintained by the Contractor and subcontractor(s) for a period of four (4) years from the date of final payment under the contract.

7.37.2 The Contractor shall insure that its subcontractors comply with this requirement and shall bear all costs (including attorney's fees) of enforcement in the event of its subcontractor's failure or refusal to fully cooperate.

7.37.3 Additionally, Sections 231-7, 235-108, 237-39 and other HRS chapters through reference, authorizes the Department of Taxation to audit all taxpayers conducting business within the State. Contractors must make available to the Department of Taxation all books and records necessary to verify compliance with the tax laws.

7.38 RECORDS MAINTENANCE, RETENTION AND ACCESS

7.38.1 The Contractor and any subcontractor whose contract for services is valued at \$25,000 or more shall, in accordance with generally acceptable accounting practices, maintain fiscal records and supporting documents and related files, papers, and reports that adequately reflect all direct and indirect expenditures and management and fiscal practices related to the Contractor and subcontractor's performance of services under this Agreement.

7.38.2 The representative of the Department, the Adjutant General of the State of Hawaii, the Attorney General, (the Federal granting agency, the Comptroller General of the United States, and any of their authorized representatives when federal funds are utilized), and the Legislative Auditor of the State of Hawaii shall have the right of access to any book, document, paper, file, or other record of the Contractor and any subcontractor that is related to the performance of services under this Agreement in order to conduct an audit or other examination and / or to make copies, excerpts and transcripts for the purposes of monitoring and evaluating the Contractor and subcontractor's performance of services and the Contractor and subcontractor's program, management, and fiscal practices to assure the proper and effective expenditure of funds and to verify all costs associated with any claims made under this Agreement.

7.38.3 The right of access shall not be limited to the required retention period but shall last as long as the records are retained. The Contractor and subcontractor shall retain all records related to the Contractor and subcontractor's performance of services under this Agreement for four (4) years from the date of final payment, except that if any litigation, claim, negotiation, investigation, audit or other action involving the records has been started before the expiration of the four (4) year period, the Contractor and subcontractors shall retain the

records until completion of the action and resolution of all issues that arise from it, or until the end of the four (4) year retention period, whichever occurs later. Furthermore, it shall be the Contractor's responsibility to enforce compliance with this provision by any subcontractor.

ARTICLE 8 - Measurement and Payment

8.1 MEASUREMENT OF QUANTITIES

8.1.1 All work completed under the Contract shall be measured by the Engineer according to United States standard measures, or as stated in this Contract. The method of measurement and computations to be used in determination of quantities of material furnished and of work performed under the contract shall conform to good engineering practice. These measurements shall be considered correct and final unless the Contractor has protested same to the Engineer and has demonstrated the existence of an error by actual physical measurement before the work has progressed in a manner which would prohibit a proper check.

8.1.2 All measurements of the area of the various surface, pavement and base courses will be made in the horizontal projection of the actual surface and no deductions will be made for fixtures or structures having an area of nine (9) square feet or less. All measurements of headers, curbs, fences and any other type of construction which is to be paid for by its length, will be made in the horizontal projection of the actual driven length from toe to top of cutoff, except where slope exceeds ten percent (10%) and for piles, which will be by actual length. All materials which are specified for measurement by the cubic yard "Loose Measurement" or "Measured in the Vehicle" shall be hauled in approved vehicles and measured therein at the point of delivery. Approved vehicles for this purpose may be of any type or size satisfactory to the Engineer, provided that the body is of such type that the actual contents may be readily and accurately determined. Unless all approved vehicles on a job are of a uniform capacity each approved vehicle must bear a plainly legible identification mark indicating the specific approved capacity. The Inspector may reject all loads not hauled in such approved vehicles.

8.2 NO WAIVER OF LEGAL RIGHTS - The Engineer shall not be precluded or estopped by any measurements, estimate or certificate made either before or after the completion and acceptance of the work and payment therefore, from showing the true amount and character of the work performed and materials furnished by the Contractor, or from showing that any such measurement estimate or certificate is untrue or incorrectly made, or rejecting the work or materials that do not conform in fact to the contract. The Engineer shall not be precluded or estopped, notwithstanding any such measurement, estimate, or certificate and payment in

accordance therewith, from recovering from the Contractor and its sureties such damages as the Department may sustain by reason of the Contractor's failure to comply with the terms of the contract. Neither the acceptance by the Engineer or any representative of the Engineer, nor any payment for or acceptance of the whole or any part of the work, nor any extension of time, or any possession taken by the Engineer, shall operate as a waiver of any portion of the contract, or of any power herein reserved, or any right to damage herein provided. A waiver of any notice requirement or breach of the contract shall not be held to be a waiver of any other notice requirement or subsequent breach.

8.3 PAYMENT FOR ADDITIONAL WORK

8.3.1 Payment for Changed Conditions – A contract modification or change order complying with section 4.4 PRICE ADJUSTMENT and section 4.5 ALLOWANCES FOR OVERHEAD AND PROFIT shall be issued for all changes that are directed under Section 4.2 CHANGES. No payment for any change including work performed under the force account provisions will be made until a change order is issued or contract modification is executed.

8.3.1.1 At the completion of the force account work or at an intermediate interval approved by the Engineer, the contractor shall submit its force account cost proposal, including; approved daily force account records with any attached invoices or receipt, to the Engineer for processing a contract modification or change order.

8.3.2 On credit proposals and proposals covering both increases and decreases, the application of overhead and profit shall be on the net change in direct costs for the performance of the work.

8.3.3 When payment is to be made for additional work directed by a field order, the total price adjustment as specified in the field order or if not specified therein for the work contained in the related change order shall be considered full compensation for all materials, labor, insurance, taxes, equipment use or rental and overheads, both field and home office including extended home and branch office overhead and other related delay impact costs.

8.3.4 Force Account Method - When, for the convenience of the Department, payment is to be made by the Force Account method, all work performed or labor and materials and equipment furnished shall be paid for as described below. Payment by the Force Account method will not alter any rights, duties and obligations under the contract.

8.3.4.1 Labor - For all hourly workers, the Contractor will receive the rate of wage including fringe benefits when such amounts are required by collective bargaining

agreement or other employment contract generally applicable to the classes of labor employed on the work, which shall be agreed upon in writing before beginning work for each and every hour that said labor is actually engaged in said work.

(a) All markups for overhead and profit shall be added subject to limitations established in Section 4.5 ALLOWANCES FOR OVERHEAD AND PROFIT.

(b) No allowance for overtime compensation will be given without the written approval of the Engineer prior to performance of such work.

8.3.4.2 Insurance and Taxes - The Contractor and subcontractor(s) will also receive the actual additional costs paid for property damage, liability, workers compensation insurance premiums, State unemployment contributions, Federal unemployment taxes, social security and Medicare taxes to which a markup of up to six percent (6%) may be added.

8.3.4.3 Materials - For materials accepted by the Engineer and used, the Contractor and subcontractor(s) shall receive the actual cost of such materials delivered and incorporated into work, plus a markup allowed under Section 4.5 ALLOWANCES FOR OVERHEAD AND PROFIT.

8.3.4.4 Subcontractors - Subcontractor costs shall be the actual costs of the subcontractor marked up as defined in this Section 8.3 plus a markup allowed under Section 4.5 ALLOWANCES FOR OVERHEAD AND PROFIT.

8.3.4.5 Equipment

(1) For machinery or special equipment (other than small tools as herein defined in clause 8.3.4.5.(h) owned or leased by the Contractor or a related entity, the use of which has been authorized by the Engineer:

(a.) The Contractor will be paid at the per-hour rental rates based on the monthly rate established for said machinery or equipment in the then-current edition of the Rental Rate Blue Book for Construction Equipment including the estimated operating cost per hour and regional correction provided therein.

(b.) If no rate is listed for a particular kind, type or size of machinery or equipment, then the monthly, hourly rates shall be as agreed upon in writing by the Contractor and the Engineer prior to the use of said machinery or equipment. If there is no agreement, the Engineer will set a rate. The Contractor may contest the rate pursuant to Section 7.25 DISPUTES AND CLAIMS.

(c.) Rental rates which are higher than those specified in the aforesaid Rental Rate Blue Book publication may be allowed where such higher rates can be justified by job conditions such as work in water and work on lava, etc. Request for such higher rates shall be submitted in writing to the Engineer for approval prior to the use of the machinery or equipment in question.

(2) For machinery or special equipment (other than small tools as herein defined in clause 8.3.4.5.(h) rented by the Contractor or a related entity specifically for the Force Account work, the use of which has been authorized by the Engineer; The Contractor will be paid the actual rental cost for the machinery or equipment, including mobilization and demobilization costs. A receipt from the equipment supplier shall be submitted to the Engineer.

(3) For machinery or special equipment (other than small tools as herein defined in clause 8.3.4.5. (h) rented by the Contractor or a related entity for use in the project, but which will also be used for the Force Account work, the use of which has been authorized by the Engineer; The Contractor will be paid the actual rental cost for the machinery or equipment. No additional mobilization and demobilization costs will be paid. A receipt from the equipment supplier shall be submitted to the Engineer.

(4) The rental rate for trucks not owned by the Contractor shall be those as established under the Hawaii State Public Utilities Commission, which will be paid for as an equipment item pursuant to paragraph 8.3.4.5. Rental rates for Contractor-owned trucks not listed in the Rental Rate Blue Book shall be agreed upon in writing by the Contractor and Engineer prior to the use of said trucks. If there is no agreement, the Engineer shall set the rate. The Contractor may contest the rate pursuant to Section 7.25 DISPUTES AND CLAIMS.

(5) The rental period shall begin at the time equipment reaches the site of work, shall include each day that the machinery or equipment is at the site of the work and shall terminate at the end of the day on which the equipment is no longer needed. In the event the equipment must standby due to work being delayed or halted by reason of design, traffic, or other related problems uncontrollable by the Contractor, excluding Saturdays, Sundays and Legal Holidays, unless the equipment is used to perform work on such days, the rental shall be two hours per day until the equipment is no longer needed.

(5.1) The rental time to be paid will be for the time actually used. Any hours or operation

- in excess of 8 hours in any one day must be approved by the Engineer prior to the performance of such work.
- (5.2) Rental time will not be allowed or credited for any day on which machinery or equipment is inoperative due to its breakdown. On such days, the Contractor will be paid only for the actual hours, if any, that the machinery or equipment was in operation.
- (5.3) In the event the Force Account work is completed in less than 8 hours, equipment rental shall nevertheless be paid for a minimum 8 hours.
- (5.4) For the purpose of determining the rental period the continuous and consecutive days shall be the normal 8-hour shift work day, Monday through Friday excluding legal holidays. Any work day to be paid less than 8 hours shall not be considered as continuous, except for equipment removed from rental for fuel and lubrication.
- (5.5) No additional premium beyond the normal rates used will be paid for equipment over 8 hours per day or 40 hours per week.
- (6) All rental rates for machinery and equipment shall include the cost of fuel, oil, lubricants, supplies, small tools, necessary attachments, repairs, maintenance, tire wear, depreciation, storage, and all other incidentals.
- (7) All machinery and equipment shall be in good working condition and suitable for the purpose for which the machinery and equipment is to be used.
- (8) Individual pieces of equipment or tools having a replacement value of one thousand dollars (\$1,000) or less, whether or not consumed by use, shall be considered to be small tools and included in the allowed markup for overhead and profit and no separate payment will be made therefore.
- (9) The total of all Force Account rental charges accrued over the duration of the contract for a specific item of equipment shall not exceed the replacement cost of that equipment.
- (9.1) The Contractor shall provide the cost of replacement to the Engineer prior to using the equipment. If the Engineer does not agree with the replacement cost, the Engineer shall set the replacement cost. The Contractor may contest the replacement cost pursuant to Section 7.25 DISPUTES AND CLAIMS.
- (10) Should the item of equipment be rented from an unrelated entity, the rental cost will be treated as an equipment cost under paragraph 8.3.4.5.
- (11) Transportation and/or Mobilization: The following provisions shall govern in determining the compensation to be paid to the Contractor for use of equipment or machinery on the Force Account method:
- (11.1) The location from which the equipment is to be moved or transported shall be approved by the Engineer.
- (11.2) Where the equipment must be transported to the site of the force account work, the Department will pay the reasonable cost of mobilizing and transporting the equipment, including its loading and unloading, from its original location to the site of force account work. Upon completion of the work the Department will pay the reasonable cost of mobilizing and transporting the equipment back to its original location or to another location, whichever cost is less.
- (11.3) The cost of transporting the equipment shall not exceed the rates established by the Hawaii State Public Utilities Commission. If such rates are nonexistent, then the rates will be determined by the Engineer based upon the prevailing rates charged by established haulers within the locale.
- (11.4) Where the equipment is self-propelled, the Department will pay the cost of moving the equipment by its own power from its original location to the site of the force account work. Upon completion of the work the Department will pay the reasonable cost of moving of the Equipment back to its original or another location, whichever cost is less.
- (11.5) At the discretion of the Engineer, when the Contractor desires to use such equipment for other than Force Account work, the costs of mobilization and transportation shall be prorated between the Force Account and non Force Account work.
- (12) Pickup trucks, vans, storage trailers, unless specifically rented for the Force Account work, shall be considered incidental to the Force Account work and the costs therefore are included in the markup

allowed under Section 4.5 ALLOWANCES FOR OVERHEAD AND PROFIT.

claimed represents the actual cost to the Contractor.

8.3.4.6 State Excise (Gross Income) Tax and Bond - A sum equal to the current percentage rate for the State excise (Gross Income) tax on the total sum determined in paragraphs 8.3.4.1, 8.3.4.2, 8.3.4.3 and 8.3.4.4 above, and the bond premium shall be added as compensation to the Contractor. The actual bond premium not to exceed one percent (1%) shall be added to items covered by paragraphs 8.3.4.1, 8.3.4.2, 8.3.4.3 and 8.3.4.4 when applicable.

(d) Insurance - Cost of property damage, liability and worker's compensation insurance premiums, unemployment insurance contributions, and social security tax.

8.4 PROGRESS AND / OR PARTIAL PAYMENTS

- (1) The compensation as determined in paragraphs 8.3.4.1, 8.3.4.2, 8.3.4.3, 8.3.4.4 and 8.3.4.5 above shall be deemed to be payment in full for work paid on a force account basis.

8.4.1 Progress Payments - The Contractor will be allowed progress payments on a monthly basis upon preparing the Monthly Payment Application forms and submitting them to the Engineer. The monthly payment shall be based on the items of work satisfactorily completed and the value thereof at unit prices and/or lump sum prices set forth in the contract as determined by the Engineer and will be subject to compliance with Section 7.9 PAYROLLS AND PAYROLL RECORDS.

8.3.4.7 Records - The Contractor and the Engineer shall compare records of the labor, materials and equipment rentals paid by the Force Account basis at the end of each day. These daily records, if signed by both parties, shall thereafter be the basis for the quantities to be paid for by the Force Account method. The Contractor shall not be entitled to payment for Force Account records not signed by the Engineer.

8.4.2 In the event the Contractor or any Subcontractor fails to submit certified copies of payrolls in accordance with the requirements of Section 7.9 PAYROLLS AND PAYROLL RECORDS, the Engineer may retain the amount due for items of work for which payroll affidavits have not been submitted on a timely basis notwithstanding satisfactory completion of the work until such records have been duly submitted. The Contractor shall not be due any interest payment for any amount thus withheld.

8.3.4.8 Statements - No payment will be made for work on a Force Account basis until the Contractor has submitted to the Engineer, duplicate itemized statements of the cost of such Force Account work detailed as follows:

8.4.3 Payment for Materials - The Contractor will also be allowed payments of the manufacturer's, supplier's, distributor's or fabricator's invoice cost of accepted materials to be incorporated in the work on the following conditions:

- (a) Laborers - Name, classification, date, daily hours, total hours, rate, and extension for each laborer and foreman and also the amount of fringe benefits payable if any.
- (b) Equipment - Designation, dates, daily hours, total hours, rental rate, and extension for each unit of machinery and equipment.
- (c) Materials
 - (c.1) Quantities of materials, prices and extensions
 - (c.2) Costs of transporting materials, if such cost is not reflected in the prices of the materials.
 - (c.3) Statements shall be accompanied and supported by receipted invoices for all materials used and transportation charges. However, if materials used on the Force Account work are not specifically purchased for such work but are taken from the Contractor's stock, then in lieu of the invoices the Contractors shall submit an affidavit certifying that such materials were taken from stock and that the amount

8.4.3.1 The materials are delivered and properly stored at the site of Work; or

8.4.3.2 For special items of materials accepted by the Engineer, the materials are delivered to the Contractor or subcontractor(s) and properly stored in an acceptable location within a reasonable distance to the site of Work.

8.4.4 Partial payments shall be made only if the Engineer finds that:

8.4.4.1 The Contractor has submitted bills of sale for the materials or otherwise demonstrates clear title to such materials.

8.4.4.2 The materials are insured for their full replacement value to the benefit of the Department against theft, fire, damages incurred in transportation to the site, and other hazards.

8.4.4.3 The materials are not subject to deterioration.

8.4.4.4 In case of materials stored off the project site, the materials are not commingled with other materials not to be incorporated into the project.

8.5 PROMPT PAYMENT §3-125-23 HAR

8.5.1 Any money paid to a Contractor for work performed by a subcontractor shall be disbursed to such subcontractor within ten (10) days after receipt of the money in accordance with the terms of the subcontract; provided that the subcontractor has met all the terms and conditions of the subcontract and there are no bona fide disputes on which the Engineer has withheld payment.

8.5.2 Upon final payment to the Contractor, full payment to all subcontractors shall be made within ten (10) days after receipt of the money, provided there are no bona fide disputes over the subcontractor's performance under the subcontract.

8.5.3 All sums retained or withheld from a subcontractor and otherwise due to the subcontractor for satisfactory performance under the subcontract shall be paid by the contracting officer to the contractor and subsequently, upon receipt from the contracting officer, by the contractor to the subcontractor within the applicable time periods specified in subsection 8.5.2 and section 103-10 HRS.

8.5.3.1 Where a subcontractor has provided evidence to the contractor of satisfactorily completing all work under their subcontract and has provided a properly documented final payment request as described in subsection (8.5.5) of this section, and;

8.5.3.1.a Has provided to the contractor an acceptable performance and payment bond for the project executed by a surety company authorized to do business in the State, as provided in section 8.6 RETAINAGE; or

8.5.3.1.b The following has occurred:

8.5.3.1.b.1 A period of ninety days after the day on which the last of the labor was done or performed and the last of the material was furnished or supplied has elapsed without written notice of a claim given to contractor and the surety, as provided for in section 103D-324 HRS; and

8.5.3.1.b.2 The subcontractor has provided to the contractor:

8.5.3.1.b.2.1 An acceptable release of retainage bond, executed by a surety company authorized to do business in the State, in an amount of not more than two times the amount being retained or withheld by the contractor.

8.5.3.1.b.2.2 Any other bond acceptable to the contractor; or

8.5.3.1.b.2.3 Any other form of mutually acceptable collateral.

8.5.4 If the contracting officer or the contractor fails to pay in accordance with this section, a penalty of one and one-half per cent per month shall be imposed upon the outstanding amounts due that were not timely paid by the responsible party. The penalty may be withheld from future payment due to the contractor, if the contractor was the responsible party. If a contractor has violated subsection 8.5.2 three or more times within two years of the first violation, the contractor shall be referred by the contracting officer to the contractor license board for action under section 444-17(14) HRS.

8.5.5 Final Payment Request. A properly documented final payment request from a subcontractor, as required by subsection 8.5.3, shall include:

8.5.5.1 Substantiation of the amounts requested;

8.5.5.2 A certification by the subcontractor, to the best of the subcontractor's knowledge and belief, that:

8.5.5.2.a The amounts requested are only for performance in accordance with the specification, terms, and conditions of the subcontract;

8.5.5.2.b The subcontractor has made payments due to its subcontractors and suppliers from previous payments received under the subcontract and will make timely payments from the proceeds of the payment covered by the certification, in accordance with their subcontract agreements and the requirements of this section; and

8.5.5.2.c The payment request does not include any amounts that the subcontractor intends to withhold or retain from a subcontractor or supplier in accordance with the terms and conditions of their subcontract; and

8.5.5.2.d The submission of documentation confirming that all other terms and conditions required under the subcontract agreement have been fully satisfied.

8.5.6 The Engineer shall return any final payment request that is defective to the contractor within seven days after receipt, with a statement identifying the defect.

8.5.7 A payment request made by a contractor to the Engineer that includes a request for sums that were withheld or retained from a subcontractor and are due to a subcontractor may not be approved under subsection 8.5.3 unless the payment request includes:

8.5.7.1 Substantiation of the amounts requested; and

8.5.7.2 A certification by the contractor, to the best of the contractor's knowledge and belief, that:

8.5.7.2.a The amounts requested are only for performance in accordance with the specifications, terms, and conditions of the contract;

8.5.7.2.b The subcontractor has made payments due to its subcontractors and suppliers from previous payments received under the contract and will make timely payments from the proceeds of the payment covered by the certification, in accordance with their subcontract agreements and the requirements of this section; and

8.5.7.2.c The payment request does not include any amounts that the contractor intends to withhold or retain from a subcontractor or supplier in accordance with the terms and conditions of their subcontract.

8.5.8 The Engineer shall return any final payment request that is defective to the contractor within seven days after receipt, with a statement identifying the defect.

8.5.9 This section shall not be construed to impair the right of a contractor or a subcontractor at any tier to negotiate and to include in their respective subcontracts provisions that provide for additional terms and conditions that are requested to be met before the subcontractor shall be entitled to receive final payment under subsection 8.5.3 of this section; provided that any such payments withheld shall be withheld by the Engineer.

8.6 RETAINAGE – The Department will retain a portion of the amount due under the contract to the contractor, to ensure the proper performance of the contract.

8.6.1 The sum withheld by the Department from the contractor shall not exceed five percent (5%) of the total amount due the contractor and that after fifty percent (50%) of the contract is completed and progress is satisfactory, no additional sum shall be withheld; provided further that if progress is not satisfactory, the Engineer may continue to withhold as retainage, sums not exceeding five percent (5%) of the amount due the contractor.

8.6.2 The retainage shall not include sums deducted as liquidated damages from moneys due or that may become due the contractor under the contract.

8.6.3 General Obligation Bonds – The contractor may withdraw retainage monies in whole or in part by providing a general obligation bond of the State or its political subdivisions suitable to the Department. The contractor shall endorse over to the Department and deposit with the Department any general obligation bond suitable to the Department, but in no case with a face value less than the value established by law, of the amount to be withdrawn. The Department may sell the bond and use the proceeds in the same way as it may use

monies directly retained from progress payments or the final payment.

8.6.4 Any retainage provided for in this section or requested to be withheld by the contractor shall be held by the Engineer.

8.6.5 A dispute between a contractor and subcontractor of any tier shall not constitute a dispute to which the State or any county is a party, and there is no right of action against the State or any county. The State and a county may not be interpleaded in any judicial or administrative proceeding involving such a dispute.

8.6.6 The retention amount withheld by the contractor from its subcontractor shall be not more than the same percentage of retainage as that of the contractor (also applies to subcontractors who subcontract work to other subcontractors) where a subcontractor has provided evidence to the contractor of:

8.6.6.1 A valid performance and a payment bond for the project that is acceptable to the contractor and executed by a surety company authorized to do business in this State;

8.6.6.2 Any other bond acceptable to the contractor; or

8.6.6.3 Any other form of collateral acceptable to the contractor.

8.6.7 A written notice of any withholding shall be issued to a subcontractor, with a copy to the procurement officer, specifying the following:

8.6.7.1 The amount to be withheld;

8.6.7.2 The specific causes for the withholding under the terms of the subcontract; and

8.6.7.3 The remedial actions to be taken by the subcontractor to receive payment of the amounts withheld.

8.6.8 The provisions of this section shall not be construed to require payment to subcontractors of retainage released to a contractor pursuant to an agreement entered into with the contracting officer meeting the requirements of subsection 8.6.3.

8.7 WARRANTY OF CLEAR TITLE - The Contractor warrants and guarantees that all work and materials covered by progress payments made thereon shall be free and clear of all liens, claims, security interests or encumbrances, and shall become the sole property of the Department. This provision shall not, however, be construed as an acceptance of the work nor shall it be construed as relieving the Contractor from the sole responsibility for all materials and work upon which

payments have been made or the restoration of any damaged work, or as waiving the right of the Department to require the fulfillment of all the items of the contract.

8.8 FINAL PAYMENT

8.8.1 Upon final settlement, the final payment amount, less all previous payments and less any sums that may have been deducted in accordance with the provisions of the contract, will be paid to the Contractor, provided the Contractor has submitted a Tax Clearance Certificate from the Department of Taxation and the Internal Revenue Service to the effect that all taxes levied or accrued under Federal and State Statutes against the contractor have been paid.

8.8.2 Sums necessary to meet any claims of any kind by the State may be retained from the sums due the Contractor until said claims have been fully and completely discharged or otherwise satisfied.

8.9 CLAIMS ARISING OUT OF PAYMENT FOR REQUIRED WORK

- If the Contractor disputes any determination made by the Engineer regarding the amount of work satisfactorily completed, or the value thereof, or the manner in which payment therefore is made or calculated, it shall notify the Engineer in writing of the specific facts supporting the Contractor's position. Such notice shall be delivered to the Engineer no later than thirty (30) days after the Contractor has been tendered payment for the subject work, or, if no payment has been tendered, not later than fifty (50) days after it has submitted the Monthly Payment Application required under Section 8.4 PROGRESS PAYMENTS herein to the Engineer for the work that is the subject of the dispute. The delivery of the written notice cannot be waived and shall be a condition precedent to the filing of the claim. No claim for additional compensation for extra work or change work shall be allowed under this provision, unless the notice requirements of Article 4 SCOPE OF WORK have been followed. Acceptance of partial payment of a Monthly Payment Application amount shall not be deemed a waiver of the right to make a claim described herein provided the notice provisions are followed. The existence of or filing of a payment claim herein shall not relieve the Contractor of its duty to continue with the performance of the contract in full compliance with the directions of the Engineer. Any notice of claim disputing the final payment made pursuant to Section 8.8 FINAL PAYMENT must be submitted in writing not later than thirty (30) days after final payment that is identified as such has been tendered to the Contractor.

ARTICLE 9 - CONFIDENTIALITY OF PERSONAL INFORMATION

9.1 Definitions. "Personal information" means an individual's first name or first initial and last name in combination with any one or more of the following data

elements, when either name or data elements are not encrypted:

1. Social Security number,
2. Driver's license number or Hawaii identification card number; or
3. Account number, credit or debit card number, access code, or password that would permit access to an individual's financial information.

Personal information does not include publicly available information that is lawfully made available to the general public from federal, state or local government records. "Technological safeguards" means the technology and the policy and procedures for use of the technology to protect and control access to personal information.

9.2 Confidentiality of Material.

- (1) All material given to or made available to the CONTRACTOR by the STATE by virtue of this Contract which is identified as personal information shall be safeguarded by the CONTRACTOR and shall not be disclosed without the prior written approval of the STATE.
- (2) CONTRACTOR agrees not to retain, use, or disclose personal information for any purpose other than as permitted or required by this Contract.
- (3) CONTRACTOR agrees to implement appropriate "technological safeguards" that are acceptable to the STATE to reduce the risk of unauthorized access to personal information.
- (4) CONTRACTOR shall report to the STATE in a prompt and complete manner any security breaches involving personal information.
- (5) CONTRACTOR agrees to mitigate, to the extent practicable, any harmful effect that is known to CONTRACTOR because of a use or disclosure of personal information by CONTRACTOR in violation of the requirements of this paragraph.
- (6) CONTRACTOR shall complete and retain a log of all disclosures made of personal information received from the STATE, or personal information created or received by CONTRACTOR on behalf of the STATE.

9.3 Security Awareness Training and Confidentiality Agreements.

- (1) CONTRACTOR certifies that all of its employees who will have access to the personal information have completed training on security

awareness topics relating to protecting personal information.

- (2) CONTRACTOR certifies that confidentiality agreements have been signed by all of its employees who will have access to the personal information acknowledging that:
 - (a) The personal information collected, used or maintained by the CONTRACTOR will be treated as confidential;
 - (b) Access to the personal information will be allowed only as necessary to perform the Contract; and
 - (c) Use of the personal information will be restricted to uses consistent with the services subject to this Contract.

9.4 Termination for Cause. In addition to any other remedies provided for by this Contract, if the STATE learns of a material breach by CONTRACTOR of this paragraph by CONTRACTOR, the State may at its sole discretion:

- (1) Provide an opportunity for the CONTRACTOR to cure the breach or end the violation; or
- (2) Immediately terminate this Contract.

9.5 Records Retention.

- (1) Upon any termination of this Contract, CONTRACTOR shall pursuant to chapter 487R, HRS, destroy all copies (paper or electronic form) of personal information received from the STATE.
- (2) The CONTRACTOR and any subcontractors shall maintain the files, books, and records that relate to the Contract, including any personal information created or received by the CONTRACTOR on behalf of the STATE, and any cost or pricing data, for three (3) years after the date of final payment under the Contract. The personal information shall continue to be confidential and shall not be disclosed without the prior written approval of the STATE. After the three (3) year retention period has ended, the files, books, and records that contain personal information shall be destroyed pursuant to chapter 487R, HRS.

ADDITIONAL GENERAL CONDITIONS FOR
CONSTRUCTION CONTRACTS

The following sections of the Hawaii Administrative Rules, Chapter §3-125 are hereby incorporated and made a part of the General Conditions.

CHANGES FOR CONSTRUCTION CONTRACTS - §HAR 3-125-4

1. Change Order. The procurement officer, at any time, and without notice to any surety in a signed writing designated or indicated to be a change order, may make changes in the work within the scope of the contract as may be found to be necessary or desirable. Such changes shall not invalidate the contract or release the sureties, and the contractor will perform the work as changed, as though it had been part of the original contract. Minor changes in the work may be directed by the procurement officer with no change in contract price or time or performance.
2. Adjustments of price or time for performance. If any change order increases or decreases the contractor's cost of, or the time required for performance of any part of the work under this contract, whether or not changed by the order, an adjustment may be made and the contract modified in writing accordingly. Any adjustment in contract price made pursuant to this clause shall be determined in accordance with the price adjustment clause of this contract. Failure of the parties to agree to an adjustment shall not excuse a contractor from proceeding with the contract as changed, provided that the State promptly and duly makes such provisional adjustments in payments or time for the direct costs of the work as changed as the State deems reasonable. The right of the contractor to dispute the contract price or time required for performance or both shall not be waived by its performing the work, provided however, that it follows the notice requirements for disputes and claims established by the contract or these rules.
3. Time Period for Claim. Within thirty days after receipt of a written change order under paragraph (1), unless such period is extended by the procurement officer in writing, the contractor shall file a notice of intent to assert claim for an adjustment. The requirement for timely written notice cannot be waived and shall be a condition precedent to the assertion of a claim.
4. Claim barred after final payment. No claim by the contractor for an adjustment hereunder shall be allowed if written notice is not given prior to final payment under this contract.
5. Claims not barred. In the absence of such a change order, nothing in this clause shall restrict the contractor's right to pursue a claim under the contract or for breach of contract.

PRICE ADJUSTMENT FOR CONSTRUCTION CONTRACTS - §HAR 3-125-13.

1. Price adjustment. Any adjustment in contract price pursuant to a clause in this contract shall be made in one or more of the following ways;
 - a. By agreement on a fixed price adjustment before commencement of the pertinent performance or as soon thereafter as practicable;
 - b. By unit prices specified in the contract or subsequently agree upon;
 - c. Whenever there is a variation in quantity for any work covered by any line item in breakdown costs provided by the contractor pursuant to contractual pre-work submittal requirements, by the procurement officer, at the procurement officer's discretion, adjusting the lump sum price proportionately;
 - d. In such other manner as the parties may mutually agree;
 - e. At the sole option of the procurement officer, by the costs attributable to the event or situation covered by the change, plus appropriate profit or fee; or
 - f. In the absence of agreement between the parties, by a unilateral determination by the procurement officer of the costs attributable to the event or situation covered by the clause, plus appropriate profit or fee, all as computed by the procurement officer in accordance with generally accepted accounting principles and applicable sections of chapters 3-123 and 3-126 (of the Hawaii Administrative Rules).

2. Determining the cost or credit. In determining the cost or credit to the State resulting from a change, the allowances for all overhead, extended overhead resulting from adjustments to contract time (including home office and field overhead) and profit combined, shall not exceed the percentages set forth below:
 - a. For the contractor, for any work performed by its own labor forces, fifteen per cent of the cost;
 - b. For each subcontractor involved, for any work performed by its own forces, fifteen per cent of the cost;
 - c. For the contractor or any subcontractor, for work performed by their subcontractors, ten per cent of the amount due the performing subcontractor.

3. Percentages for fee and overhead. Not more than three line item percentages for fee and overhead, not to exceed the maximum percentages shown above, will be allowed regardless of the number of tier subcontractors.

PROMPT PAYMENT BY CONTRACTORS TO SUBCONTRACTORS – §HAR 3-125-23

1. Prompt payment clause. Any money, other than retainage, paid to a contractor shall be dispersed to subcontractors within ten days after receipt of the money in accordance with the terms of the subcontract; provided that the subcontractor has met all the terms and conditions of the subcontract and there are no bona fide disputes; and, upon final payment to the contractor, full payment to the subcontractor, including retainage, shall be

made within ten days after receipt of the money; provided that there are no bona fide disputes over the subcontractor's performance under the subcontract.

CHANGES TO THE GENERAL CONDITIONS

1. Under ARTICLE 1 – DEFINITIONS, insert the following:

“1.70 CONTRACTING OFFICER REPRESENTATIVE (COR): The Department of Defense Project Manager (PM).”

2. Under ARTICLE 2 - PROPOSAL REQUIREMENTS AND CONDITIONS, modify section 2.6 - SUBSTITUTION OF MATERIALS AND EQUIPMENT BEFORE BID OPENING, by renaming section 2.6 - SUBSTITUTION BEFORE CONTRACT AWARD and deleting subsections 2.6.1, through 2.6.6 and substitute the following three new subsections and related paragraphs 2.6.1 through 2.6.3:

“2.6.1 For Substitutions after the Letter of Award is issued; refer to Section 6.3 SUBSTITUTION AFTER CONTRACT AWARD.

2.6.2 Unless specifically required otherwise in the contract documents, Offerors shall not submit products, materials, equipment, articles or systems for review or approval prior to submitting their Offers.

2.6.3 Offerors shall prepare their Offer forms based on the performance requirements of the materials, equipment, articles, or systems noted on the drawings and specifications. If trade names, makes, catalog numbers or brand names are specified, Offerors shall infer that these items indicate the quality, style, appearance or performance of the material, equipment, article, or systems to be used in the project. The products and equipment of manufacturers listed throughout the specifications and other manufacturers are acceptable provided they meet or exceed the materials and construction requirements specified and are installed as specified.”

3. Under Article 6, delete subsections 6.3.2.4 and 6.3.3.

(S A M P L E)

Date: _____

Engineering Officer
Department of Defense
State of Hawaii
3949 Diamond Head Road
Honolulu, Hawaii 96816-4495

Dear Sir:

Subject: REQUEST FOR SUBSTITUTION

PROJECT TITLE & JOB NO.: _____

In accordance with the requirements of the Special Provisions and as stated on the Specifications, we hereby submit for substitution, _____ sets of technical brochures and statement of variances for your review and approval for the item(s) shown below.

<u>ITEM</u>	<u>SPECIFIED BRAND</u>	<u>SUBSTITUTE BRAND</u>	<u>MODIFICATION/VARIANT FEATURES</u>
-------------	----------------------------	-----------------------------	--

I further certify that my request for substitution of the above item(s) has no other variant features.

SIGNATURE

NAME OF COMPANY AND TITLE

- NOTE:
1. Use own letterhead
 2. Submit one (1) original and two (2) copies
 3. If no variant feature indicate "None"

WEEKLY QUALITY CONTROL REPORT FORM

PROJECT: _____

PROJECT NO.: _____

WEEK OF: _____

WORK PERFORMED: _____

INSPECTION REPORT: _____

ATTACH ANY ADDITIONAL INFORMATION

DATE PREPARED: _____

INSPECTOR: _____

VERIFIED BY PRIME CONTRACTOR: _____

STATEMENT OF WORK

Construction for Stand-by Emergency Generator for Wheeler, Army Aviation Support Facility (AASF) #1, B829, Wheeler, State of Hawaii, Department of Defense, Hawaii Army National Guard, Job No: CA-202004-C1

The main objective of this project work is to provide a new stand-by emergency generator and all required components (listed / shown within the project plans and specifications) for the installation thereof at our HIARNG, Army Aviation Support Facility (AASF) within Wheeler Air Force Base.

Specifically, the project construction work includes erosion and sediment control (around a nearby concrete ditch), removal and relocation of an existing portable generator (on-site), demolition of an existing conc. slab (currently holding exist. portable generator on site), removal of an existing electrical box, other misc. demolition work, minor site gradings, installation of new ATS/By-Pass Isolation Switch, circuit breakers & other misc. equipment, minor trenching for new electrical lines to Main, construct new concrete slab, provide and install new generator, installation of new 8" CMU containment barrier and chain link fence around new generator and other misc. project work, to provide for back-up electrical power to our HIARNG AASF No. 1 – Building 829. Contractor is directed to review the project plans and specifications for a *complete* overview of the project work. As, the project plans and specifications are the construction documents (CD's) for this project work.

REQUIREMENTS and SPECIFICATIONS TO CONSTRUCT

**HAWAII ARMY NATIONAL GUARD (HIARNG)
STAND-BY EMERGENCY GENERATOR INSTALLATIONS
STATEWIDE, HAWAII
STATE JOB NO: CA-202004-C1**

WHEELER AASF #1 SITE

FOR THE STATE OF HAWAI'I, DEPARTMENT OF DEFENSE

JUNE 2023

SECTION 00 01 00 - TABLE OF CONTENTS

Pages

Table of Contents.....1 - 2

DIVISION 01 - GENERAL REQUIREMENTS

Section 01 11 00 Summary of Work.....1 - 2
Section 01 20 00 Price and Payment Procedures.....1 - 2
Section 01 30 00 Administrative Requirements1 - 3
Section 01 32 16.00 20 Project Construction Progress Schedules.....1 - 3
Section 01 33 00 Submittal Procedures1 - 12
Section 01 45 00.10 20 Quality Control.....1 - 10
Section 01 50 00 Temporary Construction Facilities and Controls1 - 9
Attachment A Construction Site Best Management Practices Checklist.....1 - 1
Attachment B Hazardous Material Inventory Log.....1 - 2
Attachment C HIARNG Spill Incident Report Form.....1 - 1
Attachment D Emergency Contacts1 - 1
Section 01 57 19 Temporary Environmental Controls.....1 - 22
Attachment A Contractor Compliance Requirements1 - 2
Attachment B Contractor Requirements Conservation1 - 3
Section 01 74 19 Construction Waste Management and Disposal1 - 8
Attachment A Monthly Waste Generation Report.....1 - 1
Section 01 78 00 Closeout Submittals1 - 12
Section 01 78 23 Operation and Maintenance Data1 - 12

DIVISION 02 - SITE CONSTRUCTION

Section 02 41 00 Demolition.....1 - 9

DIVISION 03 - CONCRETE

Section 03 30 00 Cast-in-Place Concrete1 - 37

DIVISION 04 - MASONRY

Section 04 20 00 Unit Masonry1 - 14

DIVISION 26 – ELECTRICAL

Section 26 05 19 Insulated Wire and Cable1 - 8
Section 26 05 26 Grounding and Bonding for Electrical Systems.....1 - 8
Section 26 05 48 Seismic Protection for Electrical Equipment1 - 2
Section 26 24 13 Switchboards1 - 16
Section 26 32 15 Engine-Generator Set Stationary 15-2500 KW1 - 68

Section 26 36 23 Automatic transfer Switches and By-Pass/Isolation Switch1 – 13

DIVISION 31 – EARTHWORK

Section 31 23 00 Excavation and Fill1 – 11

DIVISION 32 – EXTERIOR IMPROVEMENTS

Section 32 11 23 Aggregate Base Courses1 - 10

Section 32 31 13 Chain Link Fences and Gates1 - 9

END OF TABLE OF CONTENTS

SECTION 01 11 00

SUMMARY OF WORK

PART 1 GENERAL

1.1 SUBMITTALS

Government approval is required for submittals with a "G" classification. Submittals not having a "G" classification are for information only. When used, a code following the "G" classification identifies the office that will review the submittal for the Government. Submit the following in accordance with Section 01 33 00 SUBMITTAL PROCEDURES:

SD-01 Preconstruction Submittals
Salvage Plan; G

1.2 WORK COVERED BY CONTRACT DOCUMENTS

1.2.1 Project Description

The work includes the installation of stand-by emergency generator at the Hawaii Army National Guard Wheeler AASF #1 base site location, and incidental related work.

1.2.2 Location

The work is located at the HIARNG Wheeler base site in Mililani, approximately as indicated. The exact location will be shown by the Contracting Officer.

1.3 OCCUPANCY OF PREMISES

Building(s) will be occupied during performance of work under this Contract. Occupancy notifications will be posted in a prominent location in the work area.

Before work is started, arrange with the Contracting Officer a sequence of procedure, means of access, space for storage of materials and equipment, and use of approaches, corridors, and stairways.

1.4 EXISTING WORK

In addition to FAR 52.236-9 Protection of Existing Vegetation, Structures, Equipment, Utilities, and Improvements:

- a. Remove or alter existing work in such a manner as to prevent injury or damage to any portions of the existing work which remain.
- b. Repair or replace portions of existing work which have been altered during construction operations to match existing or adjoining work, as approved by the Contracting Officer. At the completion of operations, existing work must be in a condition equal to or better than that which existed before new work started.

1.5 LOCATION OF UNDERGROUND UTILITIES

Obtain digging permits prior to start of excavation, and comply with Installation requirements for locating and marking underground utilities. Contact local utility locating service a minimum of 48 hours prior to excavating, to mark utilities, and within sufficient time required if work occurs on a Monday or after a Holiday. Verify existing utility locations indicated on contract drawings, within area of work.

1.5.1 Notification Prior to Excavation

Notify the Contracting Officer at least 48 hours prior to starting excavation work.

1.6 SALVAGE MATERIAL AND EQUIPMENT

Items designated by the Contracting Officer to be salvaged remain the property of the Government. Segregate, itemize, deliver and off-load the salvaged property at the Government designated storage area located within the construction site.

Provide a salvage plan, listing material and equipment to be salvaged, and their storage location. Maintain property control records for material or equipment designated as salvage. Use a system of property control that is approved by the Contracting Officer. Store and protect salvaged materials and equipment until disposition by the Contracting Officer.

PART 2 PRODUCTS

Not used.

PART 3 EXECUTION

Not used.

-- End of Section --

SECTION 01 20 00

PRICE AND PAYMENT PROCEDURES

PART 1 GENERAL

1.1 SUBMITTALS

Government approval is required for submittals with a "G" classification. Submittals not having a "G" classification are for information only. When used, a code following the "G" classification identifies the office that will review the submittal for the Government. Submit the following in accordance with Section 01 33 00 SUBMITTAL PROCEDURES:

SD-03 Product Data

Weight Certificates

1.2 CONTRACT COST BREAKDOWN

The Contractor must furnish within 30 days after the date of Notice to Proceed, and prior to the submission of its first partial payment estimate, a breakdown of its single job pay item or items which will be reviewed by the Contracting Officer as to propriety of distribution of the total cost to the various accounts. Any unbalanced items as between early and late payment items or other discrepancies will be revised by the Contracting Officer to agree with a reasonable cost of the work included in the various items. This Contract cost breakdown will then be utilized as the basis for progress payments to the Contractor.

1.3 SINGLE JOB PAYMENT ITEMS

Payment items for the work of this Contract for which Contract job payments will be made are listed in the SCHEDULE and described below. All costs for items of work, which are not specifically mentioned to be included in a particular job or unit price payment item, are included in the listed job item most closely associated with the work involved. The job price and payment made for each item listed constitutes full compensation for furnishing all plant, labor, materials, and equipment, and performing any associated Contractor quality control, environmental protection, meeting safety requirements, tests and reports, and for performing all work required for which separate payment is not otherwise provided.

1.3.1 Mobilization and Demobilization

1.3.1.1 Payment

Payment will be made for costs associated with mobilization and demobilization.

1.3.1.2 Unit of Measure

Unit of measure: job.

1.4 UNIT PRICE PAYMENT ITEMS

Payment items for the work of this Contract on which the Contract unit price payments will be made are listed in the SCHEDULE and described below. The unit price and payment made for each item listed constitutes full compensation for furnishing all plant, labor, materials, and equipment, and performing any associated Contractor quality control, environmental protection, meeting safety requirements, tests and reports, and for performing all work required for each of the unit price items.

1.4.1 Excavation

1.4.1.1 Payment

Payment will be made for costs associated with excavation for the concrete slab structure, which includes performing required excavation and other operations incidental thereto, Contractor-furnished disposal area(s) and disposition of excess excavated material and unsuitable materials.

1.4.1.2 Measurement

The total quantity of excavated material for which payment will be made will be the theoretical quantity between the ground surface as determined by a survey and the grade and slope of the theoretical cross sections indicated. No allowance will be made for overdepth excavation or for the removal of any material outside the required slope lines unless authorized.

1.4.1.3 Unit of Measure

Unit of measure: cubic yard.

PART 2 PRODUCTS

Not Used

PART 3 EXECUTION

Not Used

-- End of Section --

SECTION 01 30 00

ADMINISTRATIVE REQUIREMENTS

PART 1 GENERAL

1.1 SUBMITTALS

Government approval is required for submittals with a "G" classification. Submittals not having a "G" classification are for information only. When used, a code following the "G" classification identifies the office that will review the submittal for the Government. Submit the following in accordance with Section 01 33 00 SUBMITTAL PROCEDURES:

SD-01 Preconstruction Submittals

View Location Map

Progress and Completion Pictures

1.2 VIEW LOCATION MAP

Submit, prior to or with the first digital photograph submittals, a sketch or drawing indicating the required photographic locations. Update as required if the locations are moved.

1.3 PROGRESS AND COMPLETION PICTURES

Photographically document site conditions prior to start of construction operations. Provide monthly, and within one month of the completion of work, digital photographs, 1600x1200x24 bit true color minimum resolution in pdf file format showing the sequence and progress of work. Take a minimum of 20 digital photographs each week throughout the entire project from a minimum of ten different viewpoints selected by the Contractor unless otherwise directed by the Contracting Officer. Submit with the monthly invoice two sets of digital photographs, each set on a separate compact disc (CD) or data versatile disc (DVD), cumulative of all photos to date. Indicate photographs demonstrating environmental procedures. Provide photographs for each month in a separate monthly directory and name each file to indicate its location on the view location sketch. Also provide the view location sketch on the CD or DVD as a digital file. Include a date designator in file names. Photographs provided are for unrestricted use by the Government.

1.4 MINIMUM INSURANCE REQUIREMENTS

Provide the minimum insurance coverage required by FAR 28.307-2 Liability, during the entire period of performance under this contract. Provide other insurance coverage as required by State law.

1.5 SUPERVISION

1.5.1 Superintendent Qualifications

Provide project superintendent with a minimum of 10 years experience in construction with at least 5 of those years as a superintendent on projects similar in size and complexity. The individual must have

experience in the areas of hazard identification and safety compliance. The individual must be capable of interpreting a critical path schedule and construction drawings. The qualification requirements for the alternate superintendent are the same as for the project superintendent. The Contracting Officer may request proof of the superintendent's qualifications at any point in the project if the performance of the superintendent is in question.

1.5.2 Minimum Communication Requirements

Have at least one qualified superintendent, or competent alternate, capable of reading, writing, and conversing fluently in the English language, on the job-site at all times during the performance of Contract work. In addition, if a Quality Control (QC) representative is required on the Contract, then that individual must also have fluent English communication skills.

1.5.3 Duties

The project superintendent is primarily responsible for managing subcontractors and coordinating day-to-day production and schedule adherence on the project. The superintendent is required to attend partnering meetings, and quality control meetings. The superintendent or qualified alternative must be on-site at all times during the performance of this contract until the work is completed and accepted.

1.5.4 Non-Compliance Actions

The Project Superintendent is subject to removal by the Contracting Officer for non-compliance with requirements specified in the contract and for failure to manage the project to ensure timely completion. Furthermore, the Contracting Officer may issue an order stopping all or part of the work until satisfactory corrective action has been taken. No part of the time lost due to such stop orders is acceptable as the subject of claim for extension of time for excess costs or damages by the Contractor.

1.6 PRECONSTRUCTION CONFERENCE

Immediately after award, prior to commencing any work at the site, coordinate with the Contracting Officer a time and place to meet for the Preconstruction Conference. The conference must take place within 35 calendar days after award of the contract, but prior to commencement of any work at the site. The purpose of this conference is to discuss and develop a mutual understanding of the administrative requirements of the Contract including but not limited to: daily reporting, invoicing, value engineering, safety, base-access, outage requests, hot work permits, schedule requirements, quality control, schedule of prices or earned value report, shop drawings, submittals, cybersecurity, prosecution of the work, government acceptance, final inspections and contract close-out. Contractor must present and discuss their basic approach to scheduling the construction work and any required phasing.

1.6.1 Attendees

Contractor attendees must include the Project Manager, Superintendent, Site Safety and Health Officer (SSHO), Quality Control Manager and major subcontractors.

1.7 MOBILIZATION

Contractor shall mobilize to the jobsite within 60 calendar days of contract award. Mobilize is defined as having equipment AND having a physical presence of at least one person from the contractor's team on the jobsite.

PART 2 PRODUCTS

Not Used

PART 3 EXECUTION

Not Used

-- End of Section --

SECTION 01 32 16.00 20

PROJECT CONSTRUCTION PROGRESS SCHEDULES

PART 1 GENERAL

1.1 SUBMITTALS

Government approval is required for submittals with a "G" classification. Submittals not having a "G" classification are for information only. When used, a code following the "G" classification identifies the office that will review the submittal for the Government. Submit the following in accordance with Section 01 33 00 SUBMITTAL PROCEDURES:

SD-01 Preconstruction Submittals

Baseline Construction Schedule; G

SD-07 Certificates

Monthly Updates

1.2 PRE-CONSTRUCTION SCHEDULE REQUIREMENT

Within 30 calendar days after contract award and prior to the start of work, prepare and submit to the Contracting Officer a Baseline Construction Schedule in the form of a Bar Chart Schedule in accordance with the terms in Contract Clause FAR 52.236-15 Schedules for Construction Contracts, except as modified in this contract. The approval of a Baseline Construction Schedule is a condition precedent to:

- a. The Contractor starting demolition work or construction stage(s) of the contract.
- b. Processing Contractor's invoice(s) for construction activities/items of work.
- c. Review of any schedule updates.

Submittal of the Baseline Construction Schedule, and subsequent schedule updates, is understood to be the Contractor's certification that the submitted schedule meets the requirements of the Contract Documents, represents the Contractor's plan on how the work will be accomplished, and accurately reflects the work that has been accomplished and how it was sequenced (as-built logic).

1.3 SCHEDULE FORMAT

1.3.1 Bar Chart Schedule

The Bar Chart must, as a minimum, show work activities, submittals, Government review periods, material/equipment delivery, utility outages, on-site construction, inspection, testing, and closeout activities. The Bar Chart must be time scaled and generated using an electronic spreadsheet program.

1.3.2 Schedule Submittals and Procedures

Submit Schedules and updates in hard copy and on electronic media that is acceptable to the Contracting Officer. Submit an electronic back-up of the project schedule in an import format compatible with the Government's scheduling program.

1.4 SCHEDULE MONTHLY UPDATES

Update the Construction Schedule at monthly intervals or when the schedule has been revised. Keep the updated schedule current, reflecting actual activity progress and plan for completing the remaining work. Submit copies of purchase orders and confirmation of delivery dates as directed by the Contracting Officer.

a. Narrative Report: Identify and justify the following:

- (1) Progress made in each area of the project;
- (2) Longest Path: Include printed copy on 11 by 17 inch paper, landscape setting;
- (3) Date/time constraint(s), other than those required by the contract;
- (4) Listing of changes made between the previous schedule and current updated schedule including: added or removed activities, original and remaining durations for activities that have not started, logic (sequence, constraint, lag/lead), milestones, planned sequence of operations, longest path, calendars or calendar assignments, and cost loading.
- (5) Any decrease in previously reported activity Earned Amount;
- (6) Pending items and status thereof, including permits, changes orders, and time extensions;
- (7) Status of Contract Completion Date and interim milestones;
- (8) Current and anticipated delays (describe cause of delay and corrective actions(s) and mitigation measures to minimize);
- (9) Description of current and future schedule problem areas.

For each entry in the narrative report, cite the respective Activity ID and Activity Name, the date and reason for the change, and description of the change.

1.5 3-WEEK LOOK AHEAD SCHEDULE

Prepare and issue a 3-Week Look Ahead schedule to provide a more detailed day-to-day plan of upcoming work identified on the Construction Schedule. Key the work plans to activity numbers when a NAS is required and update each week to show the planned work for the current and following two-week period. Additionally, include upcoming outages, closures, preparatory meetings, and initial meetings. Identify critical path activities on the Three-Week Look Ahead Schedule. The detail work plans are to be bar chart type schedules, maintained separately from the Construction Schedule on an electronic spreadsheet program and printed on 8-1/2 by 11 inch sheets as directed by the Contracting Officer. Activities must not exceed 5 working

days in duration and have sufficient level of detail to assign crews, tools and equipment required to complete the work. Deliver three hard copies and one electronic file of the 3-Week Look Ahead Schedule to the Contracting Officer no later than 8 a.m. each Monday, and review during the weekly CQC Coordination or Production Meeting.

1.6 CORRESPONDENCE AND TEST REPORTS:

Correspondence (e.g., letters, Requests for Information (RFIs), e-mails, meeting minute items, Production and QC Daily Reports, material delivery tickets, photographs) must reference Schedule Activities that are being addressed. Test reports (e.g., concrete, soil compaction, weld, pressure) must reference Schedule Activities that are being addressed.

1.7 ADDITIONAL SCHEDULING REQUIREMENTS

Any references to additional scheduling requirements, including systems to be inspected, tested and commissioned, that are located throughout the remainder of the Contract Documents, are subject to all requirements of this section.

PART 2 PRODUCTS

Not used.

PART 3 EXECUTION

Not used.

-- End of Section --

SECTION 01 33 00

SUBMITTAL PROCEDURES

PART 1 GENERAL

1.1 SUMMARY

1.1.1 Submittal Information

The Contracting Officer may request submittals in addition to those specified when deemed necessary to adequately describe the work covered in the respective sections. Each submittal is to be complete and in sufficient detail to allow ready determination of compliance with contract requirements.

Units of weights and measures used on all submittals are to be the same as those used in the contract drawings.

1.1.2 Project Type

The Contractor's Quality Control (CQC) System Manager are to check and approve all items before submittal and stamp, sign, and date indicating action taken. Proposed deviations from the contract requirements are to be clearly identified. Include within submittals items such as: Contractor's, manufacturer's, or fabricator's drawings; descriptive literature including (but not limited to) catalog cuts, diagrams, operating charts or curves; test reports; test cylinders; samples; O&M manuals (including parts list); certifications; warranties; and other such required submittals.

1.1.3 Submission of Submittals

Schedule and provide submittals requiring Government approval before acquiring the material or equipment covered thereby. Pick up and dispose of samples not incorporated into the work in accordance with manufacturer's Safety Data Sheets (SDS) and in compliance with existing laws and regulations.

1.2 DEFINITIONS

1.2.1 Submittal Descriptions (SD)

Submittal requirements are specified in the technical sections. Examples and descriptions of submittals identified by the Submittal Description (SD) numbers and titles follow:

SD-01 Preconstruction Submittals

Submittals that are required prior to or at the start of construction (work) or the next major phase of the construction on a multiphase contract.

For Government approved division 01 preconstruction submittals that are required prior to or commencing with the start of work shall be submitted within 30 calendar days of contract award unless specified elsewhere in the specifications. For contractor approved division 01 submittals that

are required prior to or commencing with the start of work shall be submitted within 45 calendar days of contract award unless specified elsewhere in the specifications.

Preconstruction Submittals include schedules and a tabular list of locations, features, and other pertinent information regarding products, materials, equipment, or components to be used in the work.

Certificates Of Insurance

Surety Bonds

List Of Proposed Subcontractors

List Of Proposed Products

Baseline Network Analysis Schedule (NAS)

Submittal Register

Schedule Of Prices Or Earned Value Report

Accident Prevention Plan

Work Plan

Quality Control (QC) plan

Environmental Protection Plan

1.2.2 Approving Authority

Office or designated person authorized to approve the submittal.

1.2.3 Work

As used in this section, on-site and off-site construction required by contract documents, including labor necessary to produce submittals, construction, materials, products, equipment, and systems incorporated or to be incorporated in such construction. In exception, excludes work to produce SD-01 submittals.

1.3 SUBMITTALS

Government approval is required for submittals with a "G" classification. Submittals not having a "G" classification are for information only. When used, a code following the "G" classification identifies the office that will review the submittal for the Government. Submit the following in accordance with Section 01 33 00 SUBMITTAL PROCEDURES:

SD-01 Preconstruction Submittals

Submittal Register; G

1.4 SUBMITTAL CLASSIFICATION

1.4.1 Government Approved (G)

Within the terms of the Contract Clause SPECIFICATIONS AND DRAWINGS FOR

CONSTRUCTION, submittals are considered to be "shop drawings."

1.4.2 For Information Only

Submittals not requiring Government approval will be for information only. Within the terms of the Contract Clause SPECIFICATIONS AND DRAWINGS FOR CONSTRUCTION, they are not considered to be "shop drawings."

1.5 PREPARATION

1.5.1 Submittal Format

1.5.1.1 Format of SD-01 Preconstruction Submittals

When the submittal includes a document that is to be used in the project, or is to become part of the project record, other than as a submittal, do not apply the Contractor's approval stamp to the document itself, but to a separate sheet accompanying the document.

Provide data in the unit of measure used in the contract documents.

1.5.1.2 Format for SD-02 Shop Drawings

Provide shop drawings not less than 8 1/2 by 11 inches nor more than 30 by 42 inches, except for full-size patterns or templates. Prepare drawings to accurate size, with scale indicated, unless another form is required. Ensure drawings are suitable for reproduction and of a quality to produce clear, distinct lines and letters, with dark lines on a white background.

- a. Include the nameplate data, size, and capacity on drawings. Also include applicable federal, military, industry, and technical society publication references.
- b. Dimension drawings, except diagrams and schematic drawings. Prepare drawings demonstrating interface with other trades to scale. Use the same unit of measure for shop drawings as indicated on the contract drawings. Identify materials and products for work shown.

Present shop drawings sized 8 1/2 by 11 inches as part of the bound volume for submittals. Present larger drawings in sets. Submit an electronic copy of drawings in PDF format.

1.5.1.2.1 Drawing Identification

Include on each drawing the drawing title, number, date, and revision numbers and dates, in addition to information required in paragraph IDENTIFYING SUBMITTALS.

Number drawings in a logical sequence. Each drawing is to bear the number of the submittal in a uniform location next to the title block. Place the Government contract number in the margin, immediately below the title block, for each drawing.

Reserve a blank space, no smaller than 3 inches on the right-hand side of each sheet for the Government disposition stamp.

1.5.1.3 Format of SD-03 Product Data

Present product data submittals for each section as a complete volume in

electronic PDF format. Include a table of contents, listing the page and catalog item numbers for product data.

Indicate, by prominent notation, each product that is being submitted; indicate the specification section number and paragraph number to which it pertains.

1.5.1.3.1 Product Information

Supplement product data with material prepared for the project to satisfy the submittal requirements where product data does not exist. Identify this material as developed specifically for the project, with information and format as required for submission of SD-07 Certificates.

Provide product data in units used in the Contract documents. Where product data are included in preprinted catalogs with another unit, submit the dimensions in contract document units, on a separate sheet.

1.5.1.3.2 Standards

Where equipment or materials are specified to conform to industry or technical-society reference standards of such organizations as the American National Standards Institute (ANSI), ASTM International (ASTM), National Electrical Manufacturer's Association (NEMA), Underwriters Laboratories (UL), or Association of Edison Illuminating Companies (AEIC), submit proof of such compliance. The label or listing by the specified organization will be acceptable evidence of compliance. In lieu of the label or listing, submit a certificate from an independent testing organization, competent to perform testing, and approved by the Contracting Officer. State on the certificate that the item has been tested in accordance with the specified organization's test methods and that the item complies with the specified organization's reference standard.

1.5.1.3.3 Data Submission

Collect required data submittals for each specific material, product, unit of work, or system into a single submittal that is marked for choices, options, and portions applicable to the submittal. Mark each copy of the product data identically. Partial submittals will not be accepted for expedition of the construction effort.

Submit the manufacturer's instructions before installation.

1.5.1.4 Format of SD-04 Samples

1.5.1.4.1 Sample Characteristics

Furnish samples in the following sizes, unless otherwise specified or unless the manufacturer has prepackaged samples of approximately the same size as specified:

- a. Sample of Equipment or Device: Full size.
- b. Sample of Materials Less Than 2 by 3 inches: Built up to 8 1/2 by 11 inches.
- c. Sample of Materials Exceeding 8 1/2 by 11 inches: Cut down to 8 1/2 by 11 inches and adequate to indicate color, texture, and material

variations.

- d. Sample of Linear Devices or Materials: 10 inch length or length to be supplied, if less than 10 inches. Examples of linear devices or materials are conduit and handrails.
- e. Sample Volume of Nonsolid Materials: Pint. Examples of nonsolid materials are sand and paint.
- f. Color Selection Samples: 2 by 4 inches. Where samples are specified for selection of color, finish, pattern, or texture, submit the full set of available choices for the material or product specified. Sizes and quantities of samples are to represent their respective standard unit.
- g. Sample Panel: 4 by 4 feet.
- h. Sample Installation: 100 square feet.

1.5.1.4.2 Sample Incorporation

Reusable Samples: Incorporate returned samples into work only if so specified or indicated. Incorporated samples are to be in undamaged condition at the time of use.

Recording of Sample Installation: Note and preserve the notation of any area constituting a sample installation, but remove the notation at the final clean-up of the project.

1.5.1.4.3 Comparison Sample

Samples Showing Range of Variation: Where variations in color, finish, pattern, or texture are unavoidable due to nature of the materials, submit sets of samples of not less than three units showing extremes and middle of range. Mark each unit to describe its relation to the range of the variation.

When color, texture, or pattern is specified by naming a particular manufacturer and style, include one sample of that manufacturer and style, for comparison.

1.5.1.5 Format of SD-05 Design Data

Provide design data and certificates as a complete volume in electronic PDF format.

1.5.1.6 Format of SD-06 Test Reports

Provide reports as a complete volume in electronic PDF format.

By prominent notation, indicate each report in the submittal. Indicate the specification number and paragraph number to which each report pertains.

1.5.1.7 Format of SD-07 Certificates

Provide design data and certificates as a complete volume in electronic PDF format.

1.5.1.8 Format of SD-08 Manufacturer's Instructions

Present manufacturer's instructions submittals for each section as a complete volume in electronic PDF format, bound volume. Include the manufacturer's name, trade name, place of manufacture, and catalog model or number on product data. Also include applicable federal, military, industry, and technical-society publication references. If supplemental information is needed to clarify the manufacturer's data, submit it as specified for SD-07 Certificates.

Submit the manufacturer's instructions before installation.

1.5.1.8.1 Standards

Where equipment or materials are specified to conform to industry or technical-society reference standards of such organizations as the American National Standards Institute (ANSI), ASTM International (ASTM), National Electrical Manufacturer's Association (NEMA), Underwriters Laboratories (UL), or Association of Edison Illuminating Companies (AEIC), submit proof of such compliance. The label or listing by the specified organization will be acceptable evidence of compliance. In lieu of the label or listing, submit a certificate from an independent testing organization, competent to perform testing, and approved by the Contracting Officer. State on the certificate that the item has been tested in accordance with the specified organization's test methods and that the item complies with the specified organization's reference standard.

1.5.1.9 Format of SD-09 Manufacturer's Field Reports

Provide reports as a complete volume in electronic PDF format.

By prominent notation, indicate each report in the submittal. Indicate the specification number and paragraph number to which each report pertains.

1.5.1.10 Format of SD-10 Operation and Maintenance Data (O&M)

Comply with the requirements specified in Section 01 78 23 OPERATION AND MAINTENANCE DATA for O&M Data format.

1.5.1.11 Format of SD-11 Closeout Submittals

When the submittal includes a document that is to be used in the project or is to become part of the project record, other than as a submittal, do not apply the Contractor's approval stamp to the document itself, but to a separate sheet accompanying the document.

Provide data in the unit of measure used in the contract documents.

1.5.2 Source Drawings for Shop Drawings

1.5.2.1 Source Drawings

The entire set of source drawing files (DWG) will not be provided to the Contractor. Request the specific Drawing Number for the preparation of shop drawings. Only those drawings requested to prepare shop drawings will be provided. These drawings are provided only after award.

1.5.2.2 Terms and Conditions

Data contained on these electronic files must not be used for any purpose other than as a convenience in the preparation of construction data for the referenced project. Any other use or reuse is at the sole risk of the Contractor and without liability or legal exposure to the Government. The Contractor must make no claim, and waives to the fullest extent permitted by law any claim or cause of action of any nature against the Government, its agents, or its subconsultants that may arise out of or in connection with the use of these electronic files. The Contractor must, to the fullest extent permitted by law, indemnify and hold the Government harmless against all damages, liabilities, or costs, including reasonable attorney's fees and defense costs, arising out of or resulting from the use of these electronic files.

These electronic source drawing files are not construction documents. Differences may exist between the source drawing files and the corresponding construction documents. The Government makes no representation regarding the accuracy or completeness of the electronic source drawing files, nor does it make representation to the compatibility of these files with the Contractor hardware or software. The Contractor is responsible for determining if any conflict exists. In the event that a conflict arises between the signed and sealed construction documents prepared by the Government and the furnished source drawing files, the signed and sealed construction documents govern. Use of these source drawing files does not relieve the Contractor of the duty to fully comply with the contract documents, including and without limitation the need to check, confirm and coordinate the work of all contractors for the project. If the Contractor uses, duplicates or modifies these electronic source drawing files for use in producing construction data related to this contract, remove all previous indication of ownership (seals, logos, signatures, initials and dates).

1.5.3 Electronic File Format

Provide submittals in electronic format, with the exception of material samples required for SD-04 Samples items. Compile the submittal file as a single, complete document, to include the Transmittal Form described within. Name the electronic submittal file specifically according to its contents, and coordinate the file naming convention with the Contracting Officer. Electronic files must be of sufficient quality that all information is legible. Use PDF as the electronic format, unless otherwise specified or directed by the Contracting Officer. Generate PDF files from original documents with bookmarks so that the text included in the PDF file is searchable and can be copied. If documents are scanned, optical character resolution (OCR) routines are required. Index and bookmark files exceeding 30 pages to allow efficient navigation of the file. When required, the electronic file must include a valid electronic signature or a scan of a signature.

1.6 QUANTITY OF SUBMITTALS

1.6.1 Number of SD-01 Preconstruction Submittal Copies

Unless otherwise specified, submit one electronic set of files in PDF format of administrative submittals.

1.6.2 Number of SD-02 Shop Drawing Copies

Submit one electronic file in PDF format of submittals of shop drawings requiring review and approval by a QC organization. Submit one electronic file in PDF format of shop drawings requiring review and approval by the Contracting Officer.

1.6.3 Number of SD-03 Product Data Copies

Submit in compliance with quantity requirements specified for shop drawings.

1.6.4 Number of SD-04 Samples

- a. Submit two samples, or two sets of samples showing the range of variation, of each required item. One approved sample or set of samples will be retained by the approving authority and one will be returned to the Contractor.
- b. Submit one sample panel or provide one sample installation where directed. Include components listed in the technical section or as directed.
- c. Submit one sample installation, where directed.
- d. Submit one sample of nonsolid materials.

1.6.5 Number of SD-05 Design Data Copies

Submit in compliance with quantity requirements specified for shop drawings.

1.6.6 Number of SD-06 Test Report Copies

Submit in compliance with quantity and quality requirements specified for shop drawings, other than field test results that will be submitted with QC reports.

1.6.7 Number of SD-07 Certificate Copies

Submit in compliance with quantity requirements specified for shop drawings.

1.6.8 Number of SD-08 Manufacturer's Instructions Copies

Submit in compliance with quantity requirements specified for shop drawings.

1.6.9 Number of SD-09 Manufacturer's Field Report Copies

Submit in compliance with quantity and quality requirements specified for shop drawings other than field test results that will be submitted with QC reports.

1.6.10 Number of SD-10 Operation and Maintenance Data Copies

Submit three paper copies and one electronic file in PDF format of O&M data to the Contracting Officer for review and approval.

1.6.11 Number of SD-11 Closeout Submittals Copies

Unless otherwise specified, submit three paper sets and one electronic file in PDF format of administrative submittals.

1.7 INFORMATION ONLY SUBMITTALS

Submittals without a "G" designation must be certified by the QC manager and submitted to the Contracting Officer for information-only. Approval of the Contracting Officer is not required on information only submittals. The Contracting Officer will mark "receipt acknowledged" on submittals for information and will return only the transmittal cover sheet to the Contractor. Normally, submittals for information only will not be returned. However, the Government reserves the right to return unsatisfactory submittals and require the Contractor to resubmit any item found not to comply with the contract. This does not relieve the Contractor from the obligation to furnish material conforming to the plans and specifications; will not prevent the Contracting Officer from requiring removal and replacement of nonconforming material incorporated in the work; and does not relieve the Contractor of the requirement to furnish samples for testing by the Government laboratory or for check testing by the Government in those instances where the technical specifications so prescribe.

1.8 VARIATIONS

Variations from contract requirements require Contracting Officer approval pursuant to contract Clause FAR 52.236-21 Specifications and Drawings for Construction, and will be considered where advantageous to the Government.

1.8.1 Considering Variations

Discussion of variations with the Contracting Officer before submission [of a variation submittal] will help ensure that functional and quality requirements are met and minimize rejections and resubmittals. For variations that include design changes or some material or product substitutions, the Government may require an evaluation and analysis by a licensed professional engineer hired by the contractor.

Specifically point out variations from contract requirements in a variation submittal. Failure to point out variations may cause the Government to require rejection and removal of such work at no additional cost to the Government.

1.8.2 Proposing Variations

When proposing variation, deliver a submittal, clearly marked as a "VARIATION" to the Contracting Officer, with documentation illustrating the nature and features of the variation including any necessary technical submittals and why the variation is desirable and beneficial to Government. If lower cost is a benefit, also include an estimate of the cost savings. In addition to documentation required for variation, include the submittals required for the item. Clearly mark the proposed variation in all documentation.

The Contracting Officer will indicate an approval or disapproval of the variation request; and if not approved as submitted, will indicate the Government's reasons therefore. Any work done before such approval is received is performed at the Contractor's risk."

Specifically point out variations from contract requirements in a variation submittal. Failure to point out variations may cause the Government to require rejection and removal of such work at no additional cost to the Government.

1.8.3 Warranting that Variations are Compatible

When delivering a variation for approval, the Contractor warrants that this contract has been reviewed to establish that the variation, if incorporated, will be compatible with other elements of work.

1.8.4 Review Schedule Extension

In addition to the normal submittal review period, a period of 14 calendar days will be allowed for the Government to consider submittals with variations.

1.9 SCHEDULING

Schedule and submit concurrently product data and shop drawings covering component items forming a system or items that are interrelated. Submit pertinent certifications at the same time. No delay damages or time extensions will be allowed for time lost in late submittals.

- a. Coordinate scheduling, sequencing, preparing, and processing of submittals with performance of work so that work will not be delayed by submittal processing. The Contractor is responsible for additional time required for Government reviews resulting from required resubmittals. The review period for each resubmittal is the same as for the initial submittal.
- b. Submittals required by the contract documents are listed on the submittal register. If a submittal is listed in the submittal register but does not pertain to the contract work, the Contractor is to include the submittal in the register and annotate it "N/A" with a brief explanation. Approval by the Contracting Officer does not relieve the Contractor of supplying submittals required by the contract documents but that have been omitted from the register or marked "N/A."
- c. Resubmit the submittal register and annotate it monthly with actual submission and approval dates. When all items on the register have been fully approved, no further resubmittal is required.

Contracting Officer review will be completed within fourteen calendar days after the date of submission.

1.10 GOVERNMENT APPROVING AUTHORITY

When the approving authority is the Contracting Officer, the Government will:

- a. Note the date on which the submittal was received.
- b. Review submittals for approval within the scheduling period specified and only for conformance with project design concepts and compliance with contract documents.

- c. Identify returned submittals with one of the actions defined in paragraph REVIEW NOTATIONS and with comments and markings appropriate for the action indicated.

Upon completion of review of submittals requiring Government approval, stamp and date submittals. One copy of the submittal will be retained by the Contracting Officer and one copy of the submittal will be returned to the Contractor.

1.10.1 Review Notations

Submittals will be returned to the Contractor with the following notations:

- a. Submittals marked "no exceptions taken" authorize proceeding with the work covered.
- b. Submittals marked "make corrections noted" authorize proceeding with the work covered provided that the Contractor takes no exception to the corrections.
- c. Submittals marked "rejected" or "revise and resubmit" indicate incomplete submittal or noncompliance with the contract requirements or design concept. Resubmit with appropriate changes. Do not proceed with work for this item until the resubmittal is approved.

1.11 DISAPPROVED SUBMITTALS

Make corrections required by the Contracting Officer. If the Contractor considers any correction or notation on the returned submittals to constitute a change to the contract drawings or specifications, give notice to the Contracting Officer as required under the FAR clause titled CHANGES. The Contractor is responsible for the dimensions and design of connection details and the construction of work. Failure to point out variations may cause the Government to require rejection and removal of such work at the Contractor's expense.

If changes are necessary to submittals, make such revisions and resubmit in accordance with the procedures above. No item of work requiring a submittal change is to be accomplished until the changed submittals are approved.

1.12 APPROVED SUBMITTALS

The Contracting Officer's approval of submittals is not to be construed as a complete check, and indicates only that

Approval or acceptance by the Government for a submittal does not relieve the Contractor of the responsibility for meeting the contract requirements or for any error that may exist, because under the Quality Control (QC) requirements of this contract, the Contractor is responsible for ensuring information contained within each submittal accurately conforms with the requirements of the contract documents.

After submittals have been approved or accepted by the Contracting Officer, no resubmittal for the purpose of substituting materials or equipment will be considered unless accompanied by an explanation of why a substitution is necessary.

1.13 APPROVED SAMPLES

Approval of a sample is only for the characteristics or use named in such approval and is not be construed to change or modify any contract requirements. Before submitting samples, provide assurance that the materials or equipment will be available in quantities required in the project. No change or substitution will be permitted after a sample has been approved.

Match the approved samples for materials and equipment incorporated in the work. If requested, approved samples, including those that may be damaged in testing, will be returned to the Contractor, at its expense, upon completion of the contract. Unapproved samples will also be returned to the Contractor at its expense, if so requested.

Failure of any materials to pass the specified tests will be sufficient cause for refusal to consider, under this contract, any further samples of the same brand or make as that material. The Government reserves the right to disapprove any material or equipment that has previously proved unsatisfactory in service.

Samples of various materials or equipment delivered on the site or in place may be taken by the Contracting Officer for testing. Samples failing to meet contract requirements will automatically void previous approvals. Replace such materials or equipment to meet contract requirements.

1.14 WITHHOLDING OF PAYMENT

Payment for materials incorporated in the work will not be made if required approvals have not been obtained. No payment for materials incorporated in the work will be made unless all required DOR approvals or required Government approvals have been obtained. No payment will be made for any materials incorporated into the work for any conformance review submittals or information-only submittals found to contain errors or deviations from the Solicitation or Accepted Proposal.

1.15 CERTIFICATION OF SUBMITTAL DATA

Certify the submittal data as follows on Form ENG 4025: "I certify that the above submitted items had been reviewed in detail and are correct and in strict conformance with the contract drawings and specifications except as otherwise stated.

_____NAME OF CONTRACTOR _____ SIGNATURE OF CONTRACTOR

PART 2 PRODUCTS

Not Used

PART 3 EXECUTION

Not Used

-- End of Section --

SECTION 01 45 00.10 20

QUALITY CONTROL

PART 1 GENERAL

1.1 SUBMITTALS

Government approval is required for submittals with a "G" classification. Submittals not having a "G" classification are for information only. When used, a code following the "G" classification identifies the office that will review the submittal for the Government. Submit the following in accordance with Section 01 33 00 SUBMITTAL PROCEDURES:

SD-01 Preconstruction Submittals

QC Plan; G

1.2 INFORMATION FOR THE CONTRACTING OFFICER

Prior to commencing work on construction, the Contractor can obtain a single copy set of the current report forms from the Contracting Officer. The report forms will consist of the Contractor Production Report, Contractor Production Report (Continuation Sheet), Contractor Quality Control (CQC) Report, CQC Report (Continuation Sheet), Preparatory Phase Checklist, Initial Phase Checklist, Rework Items List, and Testing Plan and Log.

Deliver the following to the Contracting Officer:

- a. CQC Report: Original and one copy, by 10:00 AM the next working week after each week that work is performed;
- b. Contractor Production Report: Original and one copy by 10:00 AM the next working week after each week that work is performed;
- c. Preparatory Phase Checklist: Original attached to the original CQC Report and one copy attached to each copy;
- d. Initial Phase Checklist: Original attached to the original CQC Report and one copy attached to each copy;
- e. Field Test Reports: One copy, within the week after the test is performed, attached to the CQC Report;
- f. QC Meeting Minutes: One copy, within the week after the meeting; and
- g. QC Certifications: As required by the paragraph entitled "QC Certifications."

1.3 QC PROGRAM REQUIREMENTS

Establish and maintain a QC program as described in this section. The QC program consists of a QC Manager, a QC plan, a Coordination and Mutual Understanding Meeting, QC meetings, three phases of control, submittal review and approval, testing, and QC certifications and documentation

necessary to provide materials, equipment, workmanship, fabrication, construction and operations which comply with the requirements of this contract. The QC program shall cover on-site and off-site work and shall be keyed to the work sequence. No work or testing may be performed unless the QC Manager is on the work site.

1.3.1 Preliminary Work Authorized Prior to Acceptance

The only work that is authorized to proceed prior to the acceptance of the QC plan is mobilization of storage and office trailers, temporary utilities, and surveying.

1.3.2 Acceptance

Acceptance of the QC plan is required prior to the start of construction. The Contracting Officer reserves the right to require changes in the QC plan and operations as necessary, including removal of personnel, to ensure the specified quality of work. The Contracting Officer reserves the right to interview any member of the QC organization at any time in order to verify the submitted qualifications.

1.3.3 Notification of Changes

Notify the Contracting Officer, in writing, of any proposed change, including changes in the QC organization personnel, a minimum of seven calendar days prior to a proposed change. Proposed changes shall be subject to the acceptance by the Contracting Officer.

1.4 QC ORGANIZATION

1.4.1 QC Manager

1.4.1.1 Duties

Provide a QC Manager at the work site to implement and manage the QC program. In addition to implementing and managing the QC program, the QC Manager may perform the duties of project superintendent. The QC Manager is required to attend the Coordination and Mutual Understanding Meeting, conduct the QC meetings, perform the three phases of control, perform submittal review and approval, ensure testing is performed and provide QC certifications and documentation required in this contract. The QC Manager is responsible for managing and coordinating the three phases of control and documentation performed by others.

1.4.1.2 Qualifications

An individual with a minimum of 5 years combined experience as a superintendent, inspector, QC Manager, project manager, or construction manager on similar size and type construction contracts which included the major trades that are part of this contract.

1.4.1.3 Construction Quality Management Training

In addition to the above experience and education requirements, the QC Manager shall have completed the course Construction Quality Management for Contractors and will have a current certificate.

1.4.2 Alternate QC Manager Duties and Qualifications

Designate an alternate for the QC Manager to serve in the event of the designated QC Manager's absence. The period of absence may not exceed two weeks at one time, and not more than 30 workdays during a calendar year. The qualification requirements for the Alternate QC Manager shall be the same as for the QC Manager.

1.5 QC PLAN

Submit a QC plan within 15 calendar days after receipt of Notice of Award. The Accepted QC plan is required prior to start of construction.

1.5.1 Requirements

Provide, for acceptance by the Contracting Officer, a QC plan submitted in a three-ring binder or in electronic PDF format, that covers both on-site and off-site work and includes the following with a table of contents listing the major sections identified with tabs.

- I. QC ORGANIZATION: A chart showing the QC organizational structure and its relationship to the production side of the organization.
- II. NAMES AND QUALIFICATIONS: In resume format, for each person in the QC organization. Include the CQM for Contractors course certification required by the paragraph entitled "Construction Quality Management Training".
- III. DUTIES, RESPONSIBILITY AND AUTHORITY OF QC PERSONAL: Of each person in the QC organization.
- IV. OUTSIDE ORGANIZATIONS: A listing of outside organizations such as architectural and consulting engineering firms that will be employed by the Contractor and a description of the services these firms will provide.
- V. APPOINTMENT LETTERS: Letters signed by an officer of the firm appointing the QC Manager and Alternate QC Manager and stating that they are responsible for managing and implementing the QC program as described in this contract. Include in this letter the QC Manager's authority to direct the removal and replacement of non-conforming work.
- VI. SUBMITTAL PROCEDURES AND INITIAL SUBMITTAL REGISTER: Procedures for reviewing, approving and managing submittals. Provide the name(s) of the person(s) in the QC organization authorized to review and certify submittals prior to approval.
- VII. TESTING LABORATORY INFORMATION: Testing laboratory information required by the paragraphs "Accredited Laboratories" or "Testing Laboratory Requirements", as applicable.
- VIII. TESTING PLAN AND LOG: A Testing Plan and Log that includes the tests required, referenced by the specification paragraph number requiring the test, the frequency, and the person responsible for each test.
- IX. PROCEDURES TO COMPLETE REWORK ITEMS: Procedures to identify, record, track and complete rework items.

- X. DOCUMENTATION PROCEDURES: Use Government formats.
- XI. LIST OF DEFINABLE FEATURES: A Definable Feature of Work (DFOW) is a task, which is separate and distinct from other tasks, has the same control requirements and work crews. The list shall be cross-referenced to the Contractor's Construction Schedule and the specification sections. For projects requiring a Progress Chart, the list of definable features of work shall include but not be limited to all items of work on the schedule. For projects requiring a Network Analysis Schedule, the list of definable features of work shall include but not be limited to all critical path activities.
- XII. PROCEDURES FOR PERFORMING THREE PHASES OF CONTROL: For each DFOW provide Preparatory and Initial Phase Checklists. Each list shall include a breakdown of quality checks that will be used when performing the quality control functions, inspections, and tests required by the contract documents. The preparatory and initial phases shall be conducted with a view towards obtaining quality construction by planning ahead and identifying potential problems.
- XIII. PERSONNEL MATRIX: Not Applicable.
- XIV. PROCEDURES FOR COMPLETION INSPECTION: See the paragraph entitled "COMPLETION INSPECTIONS".
- XV. TRAINING PROCEDURES AND TRAINING LOG: Not Applicable.

1.6 COORDINATION AND MUTUAL UNDERSTANDING MEETING

During the Pre-Construction conference and prior to the start of construction, discuss the QC program required by this contract. The purpose of this meeting is to develop a mutual understanding of the QC details, including documentation, administration for on-site and off-site work, and the coordination of the Contractor's management, production and the QC personnel. At the meeting, the Contractor will be required to explain how three phases of control will be implemented for each DFOW. Contractor's personnel required to attend shall include the QC Manager, project manager, and superintendent. Minutes of the meeting will be prepared by the QC Manager and signed by both the Contractor and the Contracting Officer. The Contractor shall provide a copy of the signed minutes to all attendees. Repeat the coordination and mutual understanding meeting when a new QC Manager is appointed.

1.7 QC MEETINGS

After the start of construction, the QC Manager shall conduct QC meetings once every two weeks at the work site with the superintendent and the foreman responsible for the ongoing and upcoming work. The QC Manager shall prepare the minutes of the meeting and provide a copy to the Contracting Officer within two working days after the meeting. As a minimum, the following shall be accomplished at each meeting:

- a. Review the minutes of the previous meeting;
- b. Review the schedule and the status of work and rework;
- c. Review the status of submittals;
- d. Review the work to be accomplished in the next two weeks and

documentation required;

- e. Resolve QC and production problems (RFIs, etc.);
- f. Address items that may require revising the QC plan; and
- g. Review Accident Prevention Plan (APP).

1.8 THREE PHASES OF CONTROL

The three phases of control shall adequately cover both on-site and off-site work and shall include the following for each DFOW.

1.8.1 Preparatory Phase

Notify the Contracting Officer at least two work days in advance of each preparatory phase. Conduct the preparatory phase with the superintendent and the foreman responsible for the definable feature of work. Document the results of the preparatory phase actions in the daily CQC Report and in the QC checklist. Perform the following prior to beginning work on each definable feature of work:

- a. Review each paragraph of the applicable specification sections;
- b. Review the contract drawings;
- c. Verify that appropriate shop drawings and submittals for materials and equipment have been submitted and approved. Verify receipt of approved factory test results, when required;
- d. Review the testing plan and ensure that provisions have been made to provide the required QC testing;
- e. Examine the work area to ensure that the required preliminary work has been completed;
- f. Examine the required materials, equipment and sample work to ensure that they are on hand and conform to the approved shop drawings and submitted data;
- g. Review the APP and appropriate Activity Hazard Analysis (AHA) to ensure that applicable safety requirements are met, and that required Safety Data Sheets (SDS) are submitted; and
- h. Discuss specific controls used and the construction methods and the approach that will be used to provide quality construction by planning ahead and identifying potential problems for each DFOW.

1.8.2 Initial Phase

Notify the Contracting Officer at least two work days in advance of each initial phase. Conduct the Initial Phase with the foreman responsible for that DFOW. Observe the initial segment of the work to ensure that it complies with contract requirements. Document the results of the Initial Phase in the daily CQC Report and in the QC checklist. Perform the following for each DFOW:

- a. Establish the quality of workmanship required;

- b. Resolve conflicts;
- c. Ensure that testing is performed by the approved laboratory; and
- d. Check work procedures for compliance with the APP and the appropriate AHA to ensure that applicable safety requirements are met.

1.8.3 Follow-Up Phase

Perform the following for on-going work daily, or more frequently as necessary, until the completion of each DFOW and document in the daily CQC Report and in the QC checklist:

- a. Ensure the work is in compliance with contract requirements;
- b. Maintain the quality of workmanship required;
- c. Ensure that testing is performed by the approved laboratory;
- d. Ensure that rework items are being corrected; and
- e. Assure manufacturers representatives have performed necessary inspections, if required.

1.8.4 Additional Preparatory and Initial Phases

Additional preparatory and initial phases shall be conducted on the same DFOW if the quality of on-going work is unacceptable, if there are changes in the applicable QC organization, if there are changes in the on-site production supervision or work crew, if work on a DFOW is resumed after substantial period of inactivity, or if other problems develop.

1.8.5 Notification of Three Phases of Control for Off-Site Work

Notify the Contracting Officer at least two weeks prior to the start of the preparatory and initial phases.

1.9 SUBMITTAL REVIEW AND APPROVAL

Procedures for submission, review, and approval of submittals are described in Section 01 33 00 SUBMITTAL PROCEDURES.

1.10 TESTING

Except as stated otherwise in the specification sections, perform sampling and testing required under this contract.

1.10.1 Accreditation Requirements

Construction materials testing laboratories must be accredited by a laboratory accreditation authority and will be required to submit a copy of the Certificate of Accreditation and Scope of Accreditation. The laboratory's scope of accreditation must include the appropriate ASTM standards (i.e.; E 329, C 1077, D 3666, D 3740, E 543) listed in the technical sections of the specifications. Laboratories engaged in Hazardous Materials Testing shall meet the requirements of OSHA and EPA. The policy applies to the specific laboratory performing the actual testing, not just the "Corporate Office."

1.10.2 Laboratory Accreditation Authorities

Laboratory Accreditation Authorities include the National Voluntary Laboratory Accreditation Program (NVLAP) administered by the National Institute of Standards and Technology, the American Association of State Highway and Transportation Officials (AASHTO), International Accreditation Services, Inc. (IAS), U. S. Army Corps of Engineers Materials Testing Center (MTC), the American Association for Laboratory Accreditation (A2LA), the Washington Association of Building Officials (WABO) (Approval authority for WABO is limited to projects within Washington State), and the Washington Area Council of Engineering Laboratories (WACEL) (Approval authority by WACEL is limited to projects within the NAVFAC WASH and Public Works Center Washington geographical area).

1.10.3 Capability Check

The Contracting Officer retains the right to check laboratory equipment in the proposed laboratory and the laboratory technician's testing procedures, techniques, and other items pertinent to testing, for compliance with the standards set forth in this contract.

1.10.4 Test Results

Cite applicable Contract requirements, tests or analytical procedures used. Provide actual results and include a statement that the item tested or analyzed conforms or fails to conform to specified requirements. If the item fails to conform, notify the Contracting Officer immediately. Conspicuously stamp the cover sheet for each report in large red letters "CONFORMS" or "DOES NOT CONFORM" to the specification requirements, whichever is applicable. Test results shall be signed by a testing laboratory representative authorized to sign certified test reports. Furnish the signed reports, certifications, and other documentation to the Contracting Officer.

1.11 QC CERTIFICATIONS

1.11.1 Contractor Quality Control Report Certification

Each CQC Report shall contain the following statement: "On behalf of the Contractor, I certify that this report is complete and correct and equipment and material used and work performed during this reporting period is in compliance with the contract drawings and specifications to the best of my knowledge except as noted in this report."

1.11.2 Invoice Certification

Furnish a certificate to the Contracting Officer with each payment request, signed by the QC Manager, attesting that as-built drawings are current and attesting that the work for which payment is requested, including stored material, is in compliance with contract requirements.

1.11.3 Completion Certification

Upon completion of work under this contract, the QC Manager shall furnish a certificate to the Contracting Officer attesting that "the work has been completed, inspected, tested and is in compliance with the contract."

1.12 COMPLETION INSPECTIONS

1.12.1 Punch-Out Inspection

Near the completion of all work or any increment thereof established by a completion time stated in the Contract clause "Commencement, Prosecution, and Completion of Work," or stated elsewhere in the specifications, the QC Manager shall conduct an inspection of the work and develop a punch list of items which do not conform to the approved drawings and specifications. Include in the punch list any remaining items of the "Rework Items List", which were not corrected prior to the Punch-Out inspection. The punch list shall include the estimated date by which the deficiencies will be corrected. A copy of the punch list shall be provided to the Contracting Officer. The QC Manager or staff shall make follow-on inspections to ascertain that all deficiencies have been corrected. Once this is accomplished, the Contractor shall notify the Government that the facility is ready for the Government "Pre-Final Inspection".

1.12.2 Pre-Final Inspection

The Government and QC manager will perform this inspection to verify that the facility is complete and ready to be occupied. A Government pre-final punch list may be developed as a result of this inspection. The QC Manager shall ensure that all items on this list are corrected prior to notifying the Government that a "Final" inspection with the customer can be scheduled. Any items noted on the "Pre-Final" inspection shall be corrected in a timely manner and shall be accomplished before the contract completion date for the work or any particular increment thereof if the project is divided into increments by separate completion dates.

1.12.3 Final Acceptance Inspection

The QC Manager, the superintendent, or other Contractor management personnel and the Contracting Officer will be in attendance at this inspection. Additional Government personnel may be in attendance. The final acceptance inspection will be formally scheduled by the Contracting Officer based upon results of the "Pre-Final Inspection". Notice shall be given to the Contracting Officer at least 14 days prior to the final inspection. The notice shall state that all specific items previously identified to the Contractor as being unacceptable will be complete by the date scheduled for the final acceptance inspection. Failure of the Contractor to have all contract work acceptably complete for this inspection will be cause for the Contracting Officer to bill the Contractor for the Government's additional inspection cost in accordance with the contract clause "Inspection of Construction".

1.13 DOCUMENTATION

Maintain current and complete records of on-site and off-site QC program operations and activities. The forms identified under the paragraph "INFORMATION FOR THE CONTRACTING OFFICER" shall be used. Reports are required for each day work is performed. Account for each calendar day throughout the life of the contract. Every space on the forms must be filled in. Use N/A if nothing can be reported in one of the spaces. The superintendent and the QC Manager must prepare and sign the Contractor Production and CQC Reports, respectively. The reporting of work shall be identified by terminology consistent with the construction schedule. In the "remarks" section in this report which will contain pertinent

information including directions received, problems encountered during construction, work progress and delays, conflicts or errors in the drawings or specifications, field changes, safety hazards encountered, instructions given and corrective actions taken, delays encountered and a record of visitors to the work site. For each remark given, identify the Schedule Activity No. that is associated with the remark.

1.13.1 Quality Control Validation

Establish and maintain the following in a series of three ring binders. Binders shall be divided and tabbed as shown below. These binders shall be readily available to the Government's Quality Assurance Team during all business hours.

- a. All completed Preparatory and Initial Phase Checklists, arranged by specification section.
- b. All milestone inspections, arranged by Activity/Event Number.
- c. A current up-to-date copy of the Testing and Plan Log with supporting field test reports, arranged by specification section.
- d. Copies of all contract modifications, arranged in numerical order. Also include documentation that modified work was accomplished.
- e. A current up-to-date copy of the Rework Items List.
- f. Maintain up-to-date copies of all punch lists issued by the QC Staff on the Contractor and Sub-Contractors and all punch lists issued by the Government.

1.13.2 As-Built Drawings

The QC Manager is required to review the as-built drawings, required by Section 01 78 00 CLOSEOUT SUBMITTALS, are kept current on a daily basis and marked to show deviations, which have been made from the Contract drawings. Ensure each deviation has been identified with the appropriate modifying documentation, e.g. PC number, modification number, RFI number, etc. The QC Manager shall initial each deviation or revision. Upon completion of work, the QC Manager shall submit a certificate attesting to the accuracy of the as-built drawings prior to submission to the Contracting Officer.

1.14 NOTIFICATION ON NON-COMPLIANCE

The Contracting Officer will notify the Contractor of any detected non-compliance with the foregoing requirements. The Contractor shall take immediate corrective action. If the contractor fails or refuses to correct the non-compliant work, the Contracting Officer will issue a non compliance notice. Such notice, when delivered to the Contractor at the work site, shall be deemed sufficient for the purpose of notification. If the Contractor fails or refuses to comply promptly, the Contracting Officer may issue an order stopping all or part of the work until satisfactory corrective action has been taken. The Contractor shall make no part of the time lost due to such stop orders the subject of claim for

extension of time, for excess costs, or damages.

PART 2 PRODUCTS

Not Used

PART 3 EXECUTION

Not Used

-- End of Section --

SECTION 01 50 00

TEMPORARY CONSTRUCTION FACILITIES AND CONTROLS

PART 1 GENERAL

1.1 REFERENCES

The publications listed below form a part of this specification to the extent referenced. The publications are referred to within the text by the basic designation only.

AMERICAN WATER WORKS ASSOCIATION (AWWA)

AWWA C511 (2017) Reduced-Pressure Principle Backflow Prevention Assembly

U.S. FEDERAL HIGHWAY ADMINISTRATION (FHWA)

MUTCD (2009; Rev 2012) Manual on Uniform Traffic Control Devices

1.2 SUBMITTALS

Government approval is required for submittals with a "G" classification. Submittals not having a "G" classification are for information only. When used, a code following the "G" classification identifies the office that will review the submittal for the Government. Submit the following in accordance with Section 01 33 00 SUBMITTAL PROCEDURES:

SD-01 Preconstruction Submittals

Construction Site Plan; G

Traffic Control Plan; G

Haul Road Plan; G

1.3 CONSTRUCTION SITE PLAN

Prior to the start of work, submit for Government approval a site plan showing the locations and dimensions of temporary facilities (including layouts and details, equipment and material storage area (onsite and offsite), and access and haul routes, avenues of ingress/egress to the fenced area and details of the fence installation. Identify any areas which may have to be graveled to prevent the tracking of mud. Indicate if the use of a supplemental or other staging area is desired. Show locations of safety and construction fences, site trailers, construction entrances, trash dumpsters, temporary sanitary facilities, and worker parking areas.

1.4 BACKFLOW PREVENTERS CERTIFICATE

1.4.1 Backflow Tester Certificate

Prior to testing, submit to the Contracting Officer certification issued by the State or local regulatory agency attesting that the backflow tester

has successfully completed a certification course sponsored by the regulatory agency. Tester must not be affiliated with a company participating in other phases of this Contract.

1.4.2 Backflow Prevention Training Certificate

Submit a certificate recognized by the State or local authority that states the Contractor has completed at least 10 hours of training in backflow preventer installations. The certificate must be current.

1.5 DOD CONDITION OF READINESS (COR)

DOD will set the Condition of Readiness (COR) based on the weather forecast for sustained winds 50 knots (58 mph) or greater. Contact the Contracting Officer for the current COR setting.

Monitor weather conditions a minimum of twice a day and take appropriate actions according to the instructions below.

Unless otherwise directed by the Contracting Officer, comply with:

- a. Condition FOUR (Sustained winds of 58 mph or greater expected within 72 hours): Normal daily jobsite cleanup and good housekeeping practices. Collect and store in piles or containers scrap lumber, waste material, and rubbish for removal and disposal at the close of each work day. Maintain the construction site including storage areas, free of accumulation of debris. Stack form lumber in neat piles less than 3.3 feet high. Remove all debris, trash, or objects that could become missile hazards. Review requirements pertaining to "Condition THREE" and continue action as necessary to attain "Condition FOUR" readiness. Contact Contracting Officer for weather and COR updates and completion of required actions.
- b. Condition THREE (Sustained winds of 58 mph or greater expected within 48 hours): Maintain "Condition FOUR" requirements and commence securing operations necessary for "Condition ONE" which cannot be completed within 18 hours. Cease all routine activities which might interfere with securing operations. Commence securing and stow all gear and portable equipment. Make preparations for securing buildings. Reinforce or remove formwork and scaffolding. Secure machinery, tools, equipment, materials, or remove from the jobsite. Expend every effort to clear all missile hazards and loose equipment from general base areas. Contact Contracting Officer for weather and COR updates and completion of required actions. Review requirements pertaining to "Condition TWO" and continue action as necessary to attain "Condition THREE" readiness.
- c. Condition TWO (Sustained winds of 58 mph or greater expected within 24 hours): Secure the jobsite, and leave Government premises.
- d. Condition ONE. (Sustained winds of 58 mph or greater expected within 12 hours): Contractor access to the jobsite and Government premises is prohibited.

PART 2 PRODUCTS

2.1 TEMPORARY SIGNAGE

2.1.1 Bulletin Board

Prior to the commencement of work activities, provide a clear weatherproof covered bulletin board not less than 36 by 48 inches in size for displaying the Equal Employment Opportunity poster, a copy of the wage decision contained in the Contract, Wage Rate Information poster, Safety and Health Information and other information approved by the Contracting Officer. Locate the bulletin board at the project site in a conspicuous place easily accessible to all employees, and in location as approved by the Contracting Officer.

2.1.2 Warning Signs

Post temporary signs, tags, and labels to give workers and the public adequate warning and caution of construction hazards. Attach signs to the perimeter fencing every 150 feet warning the public of the presence of construction hazards. Signs must require unauthorized persons to keep out of the construction site. Correct the data required by safety signs daily. Post signs at all points of entry designating the construction site as a hard hat area.

2.2 TEMPORARY TRAFFIC CONTROL

2.2.1 Haul Roads

Construct access and haul roads necessary for proper prosecution of the work under this Contract. Construct with suitable grades and widths; avoid sharp curves, blind corners, and dangerous cross traffic. Submit haul road plan for approval. Provide necessary lighting, signs, barricades, and distinctive markings for the safe movement of traffic. The method of dust control, although optional, must be adequate to ensure safe operation at all times. Location, grade, width, and alignment of construction and haul roads are subject to approval by the Contracting Officer. Lighting must be adequate to assure full and clear visibility for full width of haul road and work areas during any night work operations.

2.2.2 Barricades

Erect and maintain temporary barricades to limit public access to hazardous areas. Barricades are required whenever safe public access to paved areas such as roads, parking areas or sidewalks is prevented by construction activities or as otherwise necessary to ensure the safety of both pedestrian and vehicular traffic. Securely place barricades clearly visible with adequate illumination to provide sufficient visual warning of the hazard during both day and night.

2.3 FENCING

Provide fencing along the construction site and at all open excavations and tunnels to control access by unauthorized personnel. Safety fencing must be highly visible to be seen by pedestrians and vehicular traffic. Remove the fence upon completion and acceptance of the work.

To block public view of the construction, enclose the project work area

and Contractor lay-down area with a 8 ft high shadow-box type, wooden fence and gates.

2.3.1 Polyethylene Mesh Safety Fencing

Temporary safety fencing must be a high visibility orange colored, high density polyethylene grid, a minimum of 48 inches high and maximum mesh size of 2 inches. Fencing must extend from the grade to a minimum of 48 inches above the grade and be tightly secured to T-posts spaced as necessary to maintain a rigid and taut fence. Fencing must remain rigid and taut with a minimum of 200 pounds of force exerted on it from any direction with less than 4 inches of deflection.

2.3.2 Chain Link Panel Fencing

Temporary panel fencing must be galvanized steel chain link panels 8 feet high. Multiple fencing panels may be linked together at the bases to form long spans as needed. Each panel base must be weighted down using sand bags or other suitable materials in order for the fencing to withstand anticipated winds while remaining upright. Fencing must remain rigid and taut with a minimum of 200 pounds of force exerted on it from any direction with less than 4 inches of deflection.

2.3.3 Post-Driven Chain Link Fencing

Temporary post-driven fencing must be galvanized chain link fencing 8 feet high supported by an tightly secured to galvanized steel posts driven below grade. Fence posts must be located on minimum 10 foot centers. Posts may be set in various surfaces such as sand, soil, asphalt or concrete as necessary. Chain link fencing must remain rigid and taut with a minimum of 200 pounds of force exerted on it from any direction with less than 4 inches of deflection. Completely remove fencing and posts at the completion of construction and restore surfaces disturbed or damaged to its original condition. Locate and identify underground utilities prior to setting fence posts. Equip fence with a lockable gate. Gate must remain locked when construction personnel are not present.

2.4 BACKFLOW PREVENTERS

Certificate of Full Approval from FCCCHR List, University of Southern California, attesting that the design, size and make of each backflow preventer has satisfactorily passed the complete sequence of performance testing and evaluation for the respective level of approval. Certificate of Provisional Approval is not acceptable.

Reduced pressure principle type conforming to the applicable requirements AWWA C511. Provide backflow preventers complete with 150 pound flanged ductile iron, mounted gate valve and strainer, 304 stainless steel or bronze, internal parts.

PART 3 EXECUTION

3.1 EMPLOYEE PARKING

Construction Contract employees must park privately owned vehicles in an area designated by the Contracting Officer. Employee parking must not interfere with existing and established parking requirements of the Government installation.

3.2 AVAILABILITY AND USE OF UTILITY SERVICES

3.2.1 Temporary Utilities

Provide temporary utilities required for construction. Materials may be new or used, must be adequate for the required usage, not create unsafe conditions, and not violate applicable codes and standards.

3.2.2 Sanitation

Provide and maintain within the construction area minimum field-type sanitary facilities. Locate the facilities behind the construction fence or out of the public view. Clean units and empty wastes at least once a week or more frequently into a municipal, district, or station sanitary sewage system, or remove waste to a commercial facility. Obtain approval from the system owner prior to discharge into a municipal, district, or commercial sanitary sewer system. Penalties or fines associated with improper discharge will be the responsibility of the Contractor. Coordinate with the Contracting Officer and follow station regulations and procedures when discharging into the station sanitary sewer system. Maintain these conveniences at all times. Include provisions for pest control and elimination of odors. Government toilet facilities will not be available to Contractor's personnel.

3.2.3 Telephone

Make arrangements and pay all costs for telephone facilities desired.

3.2.4 Fire Protection

Provide temporary fire protection equipment for the protection of personnel and property during construction. Remove debris and flammable materials daily to minimize potential hazards.

3.3 STATION OPERATION AFFECT ON CONTRACTOR OPERATIONS

3.3.1 Restricted Access Areas

The Government will monitor work in areas indicated. Notify Contracting Officer at least 14 calendar days prior to starting work in these areas.

3.4 TRAFFIC PROVISIONS

3.4.1 Maintenance of Traffic

- a. Conduct operations in a manner that will not close a thoroughfare or interfere with traffic on railways or highways except with written permission of the Contracting Officer at least 15 calendar days prior to the proposed modification date, and provide a Traffic Control Plan for Government approval detailing the proposed controls to traffic movement for approval. The plan must be in accordance with State and local regulations and the MUTCD, Part VI. Make all notifications and obtain all permits required for modification to traffic movements outside Station's jurisdiction. Contractor may move oversized and slow-moving vehicles to the worksite provided requirements of the highway authority have been met.
- b. Conduct work so as to minimize obstruction of traffic, and maintain traffic on at least half of the roadway width at all times. Obtain

approval from the Contracting Officer prior to starting any activity that will obstruct traffic.

- c. Provide, erect, and maintain, at Contractor's expense, lights, barriers, signals, passageways, detours, and other items, that may be required by the Life Safety Signage, overhead protection authority having jurisdiction.
- d. Provide cones, signs, barricades, lights, or other traffic control devices and personnel required to control traffic. Do not use foil-backed material for temporary pavement marking because of its potential to conduct electricity during accidents involving downed power lines.

3.4.2 Protection of Traffic

Maintain and protect traffic on all affected roads during the construction period except as otherwise specifically directed by the Contracting Officer. Measures for the protection and diversion of traffic, including the provision of watchmen and flagmen, erection of barricades, placing of lights around and in front of equipment the work, and the erection and maintenance of adequate warning, danger, and direction signs, will be as required by the State and local authorities having jurisdiction. Provide self-illuminated (lighted) barricades during hours of darkness. Brightly-colored (orange) vests are required for all personnel working in roadways. Protect the traveling public from damage to person and property. Minimize the interference with public traffic on roads selected for hauling material to and from the site. Investigate the adequacy of existing roads and their allowable load limit. Contractor is responsible for the repair of damage to roads caused by construction operations.

3.4.3 Rush Hour Restrictions

Do not interfere with the peak traffic flows preceding and during normal operations without notification to and approval by the Contracting Officer.

3.4.4 Dust Control

Dust control methods and procedures must be approved by the Contracting Officer. Coordinate dust control methods with 01 57 19 TEMPORARY ENVIRONMENTAL CONTROLS.

3.5 REDUCED PRESSURE BACKFLOW PREVENTERS

Provide an approved reduced pressure backflow prevention assembly at each location where the Contractor taps into the Government potable water supply.

Perform backflow preventer tests using test equipment, procedures, and certification forms conforming to those outlined in the latest edition of the Manual of Cross-Connection Control published by the FCCCHR Manual. Test and tag each reduced pressure backflow preventer upon initial installation (prior to continued water use) and monthly thereafter. Tag must contain the following information: make, model, serial number, dates of tests, results, maintenance performed, and signature of tester. Record test results on certification forms conforming to requirements cited earlier in this paragraph.

3.6 CONTRACTOR'S TEMPORARY FACILITIES

Contractor-owned or -leased trailers must be identified by Government assigned numbers. Apply the number to the trailer within 14 calendar days of notification, or sooner, if directed by the Government.

Contractor is responsible for security of their property. Provide adequate outside security lighting at the temporary facilities. Trailers must be anchored to resist high winds and meet applicable state or local standards for anchoring mobile trailers.

3.6.1 Administrative Field Offices

Provide and maintain administrative field office facilities within the construction area at the designated site. Government office and warehouse facilities will not be available to the Contractor's personnel.

In the event a new building is constructed for the temporary project field office, it must be a minimum 12 feet in width, 16 feet in length and have a minimum of 7 feet headroom. Equip the building with approved electrical wiring, at least one double convenience outlet and the required switches and fuses to provide 110-120 volt power. Provide a work table with stool, desk with chair, two additional chairs, and one legal size file cabinet that can be locked. The building must be waterproof, supplied with a heater, have a minimum of two doors, electric lights, a telephone, a battery-operated smoke detector alarm, a sufficient number of adjustable windows for adequate light and ventilation, and a supply of approved drinking water. Provide approved sanitary facilities. Screen the windows and doors and provide the doors with deadbolt type locking devices or a padlock and heavy-duty hasp bolted to the door. Door hinge pins must be non-removable. Arrange the windows to open and to be securely fastened from the inside. Protect glass panels in windows by bars or heavy mesh screens to prevent easy access. In warm weather, provide air conditioning capable of maintaining the office at 50 percent relative humidity and a room temperature 20 degrees F below the outside temperature when the outside temperature is 95 degrees F. Unless otherwise directed by the Contracting Officer, remove the building from the site upon completion and acceptance of the work.

3.6.2 Storage Area

Construct a temporary 6 foot high chain link fence around trailers and materials. Include plastic strip inserts, colored brown, so that visibility through the fence is obstructed. Fence posts may be driven, in lieu of concrete bases, where soil conditions permit. Do not place or store trailers, materials, or equipment outside the fenced area unless such trailers, materials, or equipment are assigned a separate and distinct storage area by the Contracting Officer away from the vicinity of the construction site but within the installation boundaries. Trailers, equipment, or materials must not be open to public view with the exception of those items which are in support of ongoing work on the current day. Do not stockpile materials outside the fence in preparation for the next day's work. Park mobile equipment, such as tractors, wheeled lifting equipment, cranes, trucks, and like equipment within the fenced area at the end of each work day.

Keep fencing in a state of good repair and proper alignment. Grassed or unpaved areas, which are not established roadways, and will be traversed with construction equipment or other vehicles, must be covered with a

layer of gravel as necessary to prevent rutting and the tracking of mud onto paved or established roadways, should the Contractor elect to traverse them with construction equipment or other vehicles. Mow and maintain grass located within the boundaries of the construction site for the duration of the project. Grass and vegetation along fences, buildings, under trailers, and in areas not accessible to mowers must be edged or trimmed neatly.

3.6.3 Supplemental Storage Area

Upon request, and pending availability, the Contracting Officer will designate another or supplemental area for the use and storage of trailers, equipment, and materials. This area may not be in close proximity of the construction site but will be within the installation boundaries. Maintain the area in a clean and orderly fashion and secured if needed to protect supplies and equipment. Utilities will not be provided to this area by the Government.

3.6.4 Appearance of Trailers

- a. Trailers must be roadworthy and comply with all appropriate state and local vehicle requirements. Trailers which are rusted, have peeling paint or are otherwise in need of repair will not be allowed on Installation property. Trailers must present a clean and neat exterior appearance and be in a state of good repair.
- b. Maintain the temporary facilities. Failure to do so will be sufficient reason to require their removal at the Contractor's expense.

3.6.5 Safety Systems

Protect the integrity of all installed safety systems or personnel safety devices. Obtain prior approval from the Contracting Officer if entrance into systems serving safety devices is required. If it is temporarily necessary to remove or disable personnel safety devices in order to accomplish Contract requirements, provide alternative means of protection prior to removing or disabling any permanently installed safety devices or equipment and obtain approval from the Contracting Officer.

3.6.6 Weather Protection of Temporary Facilities and Stored Materials

Take necessary precautions to ensure that roof openings and other critical openings in the building are monitored carefully. Take immediate actions required to seal off such openings when rain or other detrimental weather is imminent, and at the end of each workday. Ensure that the openings are completely sealed off to protect materials and equipment in the building from damage.

3.6.6.1 Building and Site Storm Protection

When a warning of gale force winds is issued, take precautions to minimize danger to persons, and protect the work and nearby Government property. Precautions must include, but are not limited to, closing openings; removing loose materials, tools and equipment from exposed locations; and removing or securing scaffolding and other temporary work. Close openings in the work when storms of lesser intensity pose a threat to the work or any nearby Government property.

3.7 PLANT COMMUNICATIONS

Whenever the individual elements of the plant are located so that operation by normal voice between these elements is not satisfactory, install a satisfactory means of communication, such as telephone or other suitable devices and make available for use by Government personnel.

3.8 TEMPORARY PROJECT SAFETY FENCING

As soon as practicable, but not later than 15 days after the date established for commencement of work, furnish and erect temporary project safety fencing at the work site. Maintain the safety fencing during the life of the Contract and, upon completion and acceptance of the work, remove from the work site.

3.9 CLEANUP

Remove construction debris, waste materials, packaging material and the like from the work site daily. Any dirt or mud which is tracked onto paved or surfaced roadways must be cleaned away. Store all salvageable materials resulting from demolition activities within the fenced area described above or at the supplemental storage area. Neatly stack stored materials not in trailers, whether new or salvaged.

3.10 RESTORATION OF STORAGE AREA

Upon completion of the project remove the bulletin board, signs, barricades, haul roads, and all other temporary products from the site. After removal of trailers, materials, and equipment from within the fenced area, remove the fence. Restore areas used during the performance of the Contract to the original or better condition. Remove gravel used to traverse grassed areas and restore the area to its original condition, including top soil and seeding as necessary.

3.11 ATTACHMENTS

Attachment A: Construction Site BMP Checklist
Attachment B: HazMat Inventory
Attachment C: Spill Report Form
Attachment D: Emergency Contacts

-- End of Section --

Construction Site Best Management Practices Checklist

Sites < 1 acre are exempt from needing an NPDES permit, however they still need to implement Best Management Practices and Good housekeeping to prevent a harm to human health and the environment.

Best Management Practices	Yes	No	N/A
Do all containers of POL have secondary containment?			
Are storm drains and UIC protected from sediment and contaminated runoff?			
Are all containers of hazardous material and waste labeled and stored in accordance with applicable federal and state regulations?			
Are spill kits positioned in high risk locations?			
Are all stockpiles covered and/or protected from erosion			
Is the silt fence intact and effective at preventing illicit discharges?			
Are slopes stabilized to prevent erosion?			
Are dip pans being used under leaking equipment?			
Have all spills been cleaned up?			
Is the site free of trash and debris? Good housekeeping?			
Are all metal objects stored on pallets			
Is the entrance to the site stabilized to prevent tracking sediment off site?			
Are tires being washed prior to leaving the site?			
Comments			

HAZARDOUS MATERIAL INVENTORY LOG

CONTRACTOR NAME:	DATE SUBMITTED:
PROJECT NUMBER & NAME:	
PROJECT DESCRIPTION:	
PROJECT LOCATION:	
PROJECT START DATE:	PROJECT END DATE:
GOVERNMENT PROJECT MANAGER NAME AND PHONE:	REPORT PERIOD (<i>circle</i>): Start Annual End

Submit to HIARNG Environmental Office prior to start of project, within 30 days of completion, and update by 31 January.

PRODUCT NAME AND IDENTIFICATION NUMBER	MANUFACTURER	SIZE OF CONTAINER	ESTIMATED NUMBER OF CONTAINERS FOR PROJECT	MAXIMUM NUMBER OF CONTAINERS STORED ON SITE AT ANY ONE TIME	ACTUAL NUMBER OF CONTAINERS USED	FOR ENV USE

HAZARDOUS MATERIAL INVENTORY LOG

Continuation Page

PRODUCT NAME AND IDENTIFICATION NUMBER	MANUFACTURER	SIZE OF CONTAINER	ESTIMATED NUMBER OF CONTAINERS FOR PROJECT	MAXIMUM NUMBER OF CONTAINERS STORED ON SITE AT ANY ONE TIME	ACTUAL NUMBER OF CONTAINERS USED	FOR ENV USE

HIARNG Spill Incident Report Form

REPORT SPILLS IMMEDIATELY TO HIARNG-ENV AT 672-1013.
 Fax this form to 672-1262 or e-mail ng.hi.hiarnng.list.nghi-env-comp@mail.mil within 72 hours of the spill.

1	LOCATION OF SPILL (Facility/Address/Bldg):	DATE & TIME OF SPILL:	
2	CALLER NAME & PHONE NUMBER:	OSC NAME & PHONE NUMBER:	
3	ORGANIZATION REPORTING:		
4	DATE AND TIME OF DISCOVERY:	DURATION OF THE SPILL:	
5	TIME & DATE HIARNG ENV NOTIFIED (672-1013):	PERSON NOTIFIED:	
6	SUBSTANCE SPILLED (<i>Attach SDS</i>):	AMOUNT SPILLED:	SIZE OF AREA IMPACTED:
7	CAUSE AND SOURCE OF THE SPILL:		
8	EXTENT AND SEVERITY OF SPILL: Potential Dangers: <input type="checkbox"/> Fire <input type="checkbox"/> Explosion <input type="checkbox"/> Toxic Fumes/Fluid <input type="checkbox"/> Evacuation Needed <input type="checkbox"/> Damage or Injuries (<i>Specify</i>): Media into Which the Release Occurred or is Likely to Occur (Check all applicable): <input type="checkbox"/> Soil <input type="checkbox"/> Concrete <input type="checkbox"/> Asphalt <input type="checkbox"/> UIC <input type="checkbox"/> Storm Drain <input type="checkbox"/> Swale <input type="checkbox"/> Sewer <input type="checkbox"/> Stream <input type="checkbox"/> Other (<i>Specify</i>): Raining? <input type="checkbox"/> No <input type="checkbox"/> Yes Raining Imminent? <input type="checkbox"/> No <input type="checkbox"/> Yes Direction of Flow:		
9	RESPONSE ACTIONS TAKEN TO STOP, REMOVE, AND MITIGATE EFFECTS OF THE SPILL:		
10	ADDITIONAL ASSISTANCE REQUIRED? <input type="checkbox"/> No <input type="checkbox"/> Yes (<i>Specify</i>):		
11	OTHER HIARNG OR EXTERNAL AGENCIES NOTIFIED (<i>Agency, Individual, Date, Time, and Incident Number Assigned by Agency</i>): <input type="checkbox"/> Fire Dept. <input type="checkbox"/> Ambulance <input type="checkbox"/> Other (<i>Specify</i>):		
12	PREVENTIVE ACTIONS TO BE TAKEN: (<i>NOTE: This incident is required to be covered in the next unit/activity spill training.</i>)		
13	SUBMITTED BY (<i>Name, Title, Phone</i>)		

For Environmental Office Use Only.

1	REPORTABLE? <input type="checkbox"/> No <input type="checkbox"/> Yes	REPORTABLE QTY:	Samples Taken? <input type="checkbox"/> No <input type="checkbox"/> Yes
2	VERBAL NOTIFICATIONS MADE (<i>Indicate Agency, Individual, Date, and Time Notified, and any Incident Number Assigned</i>) <input type="checkbox"/> SERC (HEER): <input type="checkbox"/> LEPC: <input type="checkbox"/> NRC (800) 424-8801: <input type="checkbox"/> Other (<i>Specify</i>): DATE WRITTEN NOTIFICATIONS MADE:		
3	CORRECTIVE ACTIONS TAKEN/ RECOMMENDED TO PRECLUDE RECURRENCE:		

EMERGENCY CONTACTS

Contractor: [Company Name]

Site Supervisor: [Name, Phone]

Spill/Emergency: [Name, Phone]

After Hours:[Name, Phone]

Police/Fire: 911

Government POC: [Name, Phone]

HIARNG Environmental Office
Spill Notification Hotline: 672-1013

SECTION 01 57 19

TEMPORARY ENVIRONMENTAL CONTROLS

PART 1 GENERAL

1.1 REFERENCES

The publications listed below form a part of this specification to the extent referenced. The publications are referred to within the text by the basic designation only.

U.S. NATIONAL ARCHIVES AND RECORDS ADMINISTRATION (NARA)

29 CFR 1910.120	Hazardous Waste Operations and Emergency Response
29 CFR 1910.1053	Respirable Crystalline Silica
29 CFR 1926.1153	Respirable Crystalline Silica
40 CFR 50	National Primary and Secondary Ambient Air Quality Standards
40 CFR 60	Standards of Performance for New Stationary Sources
40 CFR 63	National Emission Standards for Hazardous Air Pollutants for Source Categories
40 CFR 64	Compliance Assurance Monitoring
40 CFR 241	Guidelines for Disposal of Solid Waste
40 CFR 243	Guidelines for the Storage and Collection of Residential, Commercial, and Institutional Solid Waste
40 CFR 258	Subtitle D Landfill Requirements
40 CFR 260	Hazardous Waste Management System: General
40 CFR 261	Identification and Listing of Hazardous Waste
40 CFR 261.7	Residues of Hazardous Waste in Empty Containers
40 CFR 262	Standards Applicable to Generators of Hazardous Waste
40 CFR 263	Standards Applicable to Transporters of Hazardous Waste
40 CFR 264	Standards for Owners and Operators of Hazardous Waste Treatment, Storage, and Disposal Facilities

40 CFR 265	Interim Status Standards for Owners and Operators of Hazardous Waste Treatment, Storage, and Disposal Facilities
40 CFR 266	Standards for the Management of Specific Hazardous Wastes and Specific Types of Hazardous Waste Management Facilities
40 CFR 268	Land Disposal Restrictions
40 CFR 273	Standards for Universal Waste Management
40 CFR 279	Standards for the Management of Used Oil
40 CFR 300	National Oil and Hazardous Substances Pollution Contingency Plan
40 CFR 300.125	National Oil and Hazardous Substances Pollution Contingency Plan - Notification and Communications
40 CFR 355	Emergency Planning and Notification
40 CFR 403	General Pretreatment Regulations for Existing and New Sources of Pollution
49 CFR 171	General Information, Regulations, and Definitions
49 CFR 172	Hazardous Materials Table, Special Provisions, Hazardous Materials Communications, Emergency Response Information, and Training Requirements
49 CFR 173	Shippers - General Requirements for Shipments and Packagings
49 CFR 178	Specifications for Packagings

1.2 DEFINITIONS

1.2.1 Class I and II Ozone Depleting Substance (ODS)

Class I ODS is defined in Section 602(a) of The Clean Air Act. A list of Class I ODS can be found on the EPA website at the following weblink.
<https://www.epa.gov/ozone-layer-protection/ozone-depleting-substances>.

Class II ODS is defined in Section 602(s) of The Clean Air Act. A list of Class II ODS can be found on the EPA website at the following weblink.
<https://www.epa.gov/ozone-layer-protection/ozone-depleting-substances>.

1.2.2 Contractor Generated Hazardous Waste

Contractor generated hazardous waste is materials that, if abandoned or disposed of, may meet the definition of a hazardous waste. These waste streams would typically consist of material brought on site by the Contractor to execute work, but are not fully consumed during the course of construction. Examples include, but are not limited to, excess paint

thinners (i.e. methyl ethyl ketone, toluene), waste thinners, excess paints, excess solvents, waste solvents, excess pesticides, and contaminated pesticide equipment rinse water.

1.2.3 Electronics Waste

Electronics waste is discarded electronic devices intended for salvage, recycling, or disposal.

1.2.4 Environmental Pollution and Damage

Environmental pollution and damage is the presence of chemical, physical, or biological elements or agents which adversely affect human health or welfare; unfavorably alter ecological balances of importance to human life; affect other species of importance to humankind; or degrade the environment aesthetically, culturally or historically.

1.2.5 Environmental Protection

Environmental protection is the prevention/control of pollution and habitat disruption that may occur to the environment during construction. The control of environmental pollution and damage requires consideration of land, water, and air; biological and cultural resources; and includes management of visual aesthetics; noise; solid, chemical, gaseous, and liquid waste; radiant energy and radioactive material as well as other pollutants.

1.2.6 Hazardous Debris

As defined in paragraph SOLID WASTE, debris that contains listed hazardous waste (either on the debris surface, or in its interstices, such as pore structure) in accordance with 40 CFR 261. Hazardous debris also includes debris that exhibits a characteristic of hazardous waste in accordance with 40 CFR 261.

1.2.7 Hazardous Materials

Hazardous materials as defined in 49 CFR 171 and listed in 49 CFR 172.

Hazardous material is any material that: Is regulated as a hazardous material in accordance with 49 CFR 173; or requires a Safety Data Sheet (SDS) in accordance with 29 CFR 1910.120; or during end use, treatment, handling, packaging, storage, transportation, or disposal meets or has components that meet or have potential to meet the definition of a hazardous waste as defined by 40 CFR 261 Subparts A, B, C, or D. Designation of a material by this definition, when separately regulated or controlled by other sections or directives, does not eliminate the need for adherence to that hazard-specific guidance which takes precedence over this section for "control" purposes. Such material includes ammunition, weapons, explosive actuated devices, propellants, pyrotechnics, chemical and biological warfare materials, medical and pharmaceutical supplies, medical waste and infectious materials, bulk fuels, radioactive materials, and other materials such as asbestos, mercury, and polychlorinated biphenyls (PCBs).

1.2.8 Hazardous Waste

Hazardous Waste is any material that meets the definition of a solid waste and exhibit a hazardous characteristic (ignitability, corrosivity,

reactivity, or toxicity) as specified in 40 CFR 261, Subpart C, or contains a listed hazardous waste as identified in 40 CFR 261, Subpart D.

1.2.9 Land Application

Land Application means spreading or spraying discharge water at a rate that allows the water to percolate into the soil. No sheeting action, soil erosion, discharge into storm sewers, discharge into defined drainage areas, or discharge into the "waters of the United States" must occur. Comply with federal, state, and local laws and regulations.

1.2.10 Municipal Separate Storm Sewer System (MS4) Permit

MS4 permits are those held by installations to obtain NPDES permit coverage for their stormwater discharges.

1.2.11 National Pollutant Discharge Elimination System (NPDES)

The NPDES permit program controls water pollution by regulating point sources that discharge pollutants into waters of the United States.

1.2.12 Oily Waste

Oily waste are those materials that are, or were, mixed with Petroleum, Oils, and Lubricants (POLs) and have become separated from that POLs. Oily wastes also means materials, including wastewaters, centrifuge solids, filter residues or sludges, bottom sediments, tank bottoms, and sorbents which have come into contact with and have been contaminated by, POLs and may be appropriately tested and discarded in a manner which is in compliance with other state and local requirements.

This definition includes materials such as oily rags, "kitty litter" sorbent clay and organic sorbent material. These materials may be land filled provided that: It is not prohibited in other state regulations or local ordinances; the amount generated is "de minimus" (a small amount); it is the result of minor leaks or spills resulting from normal process operations; and free-flowing oil has been removed to the practicable extent possible. Large quantities of this material, generated as a result of a major spill or in lieu of proper maintenance of the processing equipment, are a solid waste. As a solid waste, perform a hazardous waste determination prior to disposal. As this can be an expensive process, it is recommended that this type of waste be minimized through good housekeeping practices and employee education.

1.2.13 Regulated Waste

Regulated waste are solid wastes that have specific additional federal, state, or local controls for handling, storage, or disposal.

1.2.14 Sediment

Sediment is soil and other debris that have eroded and have been transported by runoff water or wind.

1.2.15 Solid Waste

Solid waste is a solid, liquid, semi-solid or contained gaseous waste. A solid waste can be a hazardous waste, non-hazardous waste, or non-Resource Conservation and Recovery Act (RCRA) regulated waste.

1.2.15.1 Debris

Debris is non-hazardous solid material generated during the construction, demolition, or renovation of a structure that exceeds 2.5-inch particle size that is: a manufactured object; plant or animal matter; or natural geologic material (for example, cobbles and boulders), broken or removed concrete, masonry, and rock asphalt paving; ceramics; roofing paper and shingles. Inert materials may not be reinforced with or contain ferrous wire, rods, accessories and weldments. A mixture of debris and other material such as soil or sludge is also subject to regulation as debris if the mixture is comprised primarily of debris by volume, based on visual inspection.

1.2.15.2 Green Waste

Green waste is the vegetative matter from landscaping, land clearing and grubbing, including, but not limited to, grass, bushes, scrubs, small trees and saplings, tree stumps and plant roots. Marketable trees, grasses and plants that are indicated to remain, be re-located, or be re-used are not included.

1.2.15.3 Material Not Regulated As Solid Waste

Material not regulated as solid waste is nuclear source or byproduct materials regulated under the Federal Atomic Energy Act of 1954 as amended; suspended or dissolved materials in domestic sewage effluent or irrigation return flows, or other regulated point source discharges; regulated air emissions; and fluids or wastes associated with natural gas or crude oil exploration or production.

1.2.15.4 Non-Hazardous Waste

Non-hazardous waste is waste that is excluded from, or does not meet, hazardous waste criteria in accordance with 40 CFR 263.

1.2.15.5 Recyclables

Recyclables are materials, equipment and assemblies such as doors, windows, door and window frames, plumbing fixtures, glazing and mirrors that are recovered and sold as recyclable, wiring, insulated/non-insulated copper wire cable, wire rope, and structural components. It also includes commercial-grade refrigeration equipment with Freon removed, household appliances where the basic material content is metal, clean polyethylene terephthalate bottles, cooking oil, used fuel oil, textiles, high-grade paper products and corrugated cardboard, stackable pallets in good condition, clean crating material, and clean rubber/vehicle tires. Metal meeting the definition of lead contaminated or lead based paint contaminated may not be included as recyclable if sold to a scrap metal company. Paint cans that meet the definition of empty containers in accordance with 40 CFR 261.7 may be included as recyclable if sold to a scrap metal company.

1.2.15.6 Surplus Soil

Surplus soil is existing soil that is in excess of what is required for this work, including aggregates intended, but not used, for on-site mixing of concrete, mortars, and paving. Contaminated soil meeting the definition of hazardous material or hazardous waste is not included and

must be managed in accordance with paragraph HAZARDOUS MATERIAL MANAGEMENT.

1.2.15.7 Scrap Metal

This includes scrap and excess ferrous and non-ferrous metals such as reinforcing steel, structural shapes, pipe, and wire that are recovered or collected and disposed of as scrap. Scrap metal meeting the definition of hazardous material or hazardous waste is not included.

1.2.15.8 Wood

Wood is dimension and non-dimension lumber, plywood, chipboard, hardboard. Treated or painted wood that meets the definition of lead contaminated or lead based contaminated paint is not included. Treated wood includes, but is not limited to, lumber, utility poles, crossties, and other wood products with chemical treatment.

1.2.16 Surface Discharge

Surface discharge means discharge of water into drainage ditches, storm sewers, creeks or "waters of the United States". Surface discharges are discrete, identifiable sources and require a permit from the governing agency. Comply with federal, state, and local laws and regulations.

1.2.17 Wastewater

Wastewater is the used water and solids from a community that flow to a treatment plant.

1.2.17.1 Stormwater

Stormwater is any precipitation in an urban or suburban area that does not evaporate or soak into the ground, but instead collects and flows into storm drains, rivers, and streams.

1.2.18 Waters of the United States

Waters of the United States means Federally jurisdictional waters, including wetlands, that are subject to regulation under Section 404 of the Clean Water Act or navigable waters, as defined under the Rivers and Harbors Act.

1.2.19 Wetlands

Wetlands are those areas that are inundated or saturated by surface or groundwater at a frequency and duration sufficient to support, and that under normal circumstances do support, a prevalence of vegetation typically adapted for life in saturated soil conditions.

1.2.20 Universal Waste

The universal waste regulations streamline collection requirements for certain hazardous wastes in the following categories: batteries, pesticides, mercury-containing equipment (for example, thermostats), and lamps (for example, fluorescent bulbs). The rule is designed to reduce hazardous waste in the municipal solid waste (MSW) stream by making it easier for universal waste handlers to collect these items and send them for recycling or proper disposal. These regulations can be found at 40 CFR 273.

1.3 SUBMITTALS

Government approval is required for submittals with a "G" classification. Submittals not having a "G" classification are for information only. When used, a code following the "G" classification identifies the office that will review the submittal for the Government. Submit the following in accordance with Section 01 33 00 SUBMITTAL PROCEDURES:

SD-01 Preconstruction Submittals

Preconstruction Survey

Solid Waste Management Permit; G

Regulatory Notifications; G

Environmental Protection Plan; G

Stormwater Pollution Prevention Plan (SWPPP); G

Stormwater Notice of Intent (for NPDES coverage under the general permit for construction activities); G

Dirt and Dust Control Plan; G

Employee Training Records; G

Environmental Manager Qualifications; G

SD-06 Test Reports

Laboratory Analysis

Inspection Reports

Monthly Solid Waste Disposal Report; G

SD-07 Certificates

Certificate of Competency

Erosion and Sediment Control Inspector Qualifications

SD-11 Closeout Submittals

Stormwater Pollution Prevention Plan Compliance Notebook; G

Stormwater Notice of Termination (for NPDES coverage under the general permit for construction activities); G

Waste Determination Documentation; G

Disposal Documentation for Hazardous and Regulated Waste; G

Assembled Employee Training Records; G

Solid Waste Management Permit; G

Project Solid Waste Disposal Documentation Report; G

Hazardous Waste/Debris Management; G

Regulatory Notifications; G

Sales Documentation; G

Contractor Certification

As-Built Topographic Survey

1.4 ENVIRONMENTAL PROTECTION REQUIREMENTS

Provide and maintain, during the life of the contract, environmental protection as defined. Plan for and provide environmental protective measures to control pollution that develops during construction practice. Plan for and provide environmental protective measures required to correct conditions that develop during the construction of permanent or temporary environmental features associated with the project. Protect the environmental resources within the project boundaries and those affected outside the limits of permanent work during the entire duration of this Contract. Comply with federal, state, and local regulations pertaining to the environment, including water, air, solid waste, hazardous waste and substances, oily substances, and noise pollution.

Tests and procedures assessing whether construction operations comply with Applicable Environmental Laws may be required. Analytical work must be performed by qualified laboratories; and where required by law, the laboratories must be certified.

1.4.1 Conformance with the Environmental Management System

Perform work under this contract consistent with the policy and objectives identified in the installation's Environmental Management System (EMS). Perform work in a manner that conforms to objectives and targets of the environmental programs and operational controls identified by the EMS. Support Government personnel when environmental compliance and EMS audits are conducted by escorting auditors at the Project site, answering questions, and providing proof of records being maintained. Provide monitoring and measurement information as necessary to address environmental performance relative to environmental, energy, and transportation management goals. In the event an EMS nonconformance or environmental noncompliance associated with the contracted services, tasks, or actions occurs, take corrective and preventative actions. In addition, employees must be aware of their roles and responsibilities under the installation EMS and of how these EMS roles and responsibilities affect work performed under the contract.

Coordinate with the installation's EMS coordinator to identify training needs associated with environmental aspects and the EMS, and arrange training or take other action to meet these needs. Provide training documentation to the Contracting Officer. The Installation Environmental Office will retain associated environmental compliance records. Make EMS Awareness training completion certificates available to Government auditors during EMS audits and include the certificates in the Employee Training Records. See paragraph EMPLOYEE TRAINING RECORDS.

1.5 QUALITY ASSURANCE

1.5.1 Preconstruction Survey and Protection of Features

This paragraph supplements the Contract Clause PROTECTION OF EXISTING VEGETATION, STRUCTURES, EQUIPMENT, UTILITIES, AND IMPROVEMENTS. Prior to start of any onsite construction activities, perform a Preconstruction Survey of the project site with the Contracting Officer, and take photographs showing existing environmental conditions in and adjacent to the site. Submit a report for the record. Include in the report a plan describing the features requiring protection under the provisions of the Contract Clauses, which are not specifically identified on the drawings as environmental features requiring protection along with the condition of trees, shrubs and grassed areas immediately adjacent to the site of work and adjacent to the Contractor's assigned storage area and access route(s), as applicable. The Contractor and the Contracting Officer will sign this survey report upon mutual agreement regarding its accuracy and completeness. Protect those environmental features included in the survey report and any indicated on the drawings, regardless of interference that their preservation may cause to the work under the Contract.

1.5.2 Regulatory Notifications

Provide regulatory notification requirements in accordance with federal, state and local regulations. In cases where the Government will also provide public notification (such as stormwater permitting), coordinate with the Contracting Officer. Submit copies of regulatory notifications to the Contracting Officer at least 14 days prior to commencement of work activities. Typically, regulatory notifications must be provided for the following (this listing is not all-inclusive): demolition, renovation, NPDES defined site work, construction, removal or use of a permitted air emissions source, and remediation of controlled substances (asbestos, hazardous waste, lead paint).

1.5.3 Environmental Brief

Attend an environmental brief to be included in the preconstruction meeting. Provide the following information: types, quantities, and use of hazardous materials that will be brought onto the installation; and types and quantities of wastes/wastewater that may be generated during the Contract. Discuss the results of the Preconstruction Survey at this time.

Prior to initiating any work on site, meet with the Contracting Officer and installation Environmental Office to discuss the proposed Environmental Protection Plan (EPP). Develop a mutual understanding relative to the details of environmental protection, including measures for protecting natural and cultural resources, required reports, required permits, permit requirements (such as mitigation measures), and other measures to be taken.

1.5.4 Non-Compliance Notifications

The Contracting Officer will notify the Contractor in writing of any observed noncompliance with federal, state or local environmental laws or regulations, permits, and other elements of the Contractor's EPP. After receipt of such notice, inform the Contracting Officer of the proposed corrective action and take such action when approved by the Contracting Officer. The Contracting Officer may issue an order stopping all or part of the work until satisfactory corrective action has been taken. FAR

52.242-14 Suspension of Work provides that a suspension, delay, or interruption of work due to the fault or negligence of the Contractor allows for no adjustments to the contract for time extensions or equitable adjustments. In addition to a suspension of work, the Contracting Officer may use additional authorities under the contract or law.

1.6 ENVIRONMENTAL PROTECTION PLAN

The purpose of the EPP is to present an overview of known or potential environmental issues that must be considered and addressed during construction. Incorporate construction related objectives and targets from the installation's EMS into the EPP. Include in the EPP measures for protecting natural and cultural resources, required reports, and other measures to be taken. Meet with the Contracting Officer or Contracting Officer Representative to discuss the EPP and develop a mutual understanding relative to the details for environmental protection including measures for protecting natural resources, required reports, and other measures to be taken. Submit the EPP within 15 days after notice to proceed and not less than 10 days before the preconstruction meeting. Revise the EPP throughout the project to include any reporting requirements, changes in site conditions, or contract modifications that change the project scope of work in a way that could have an environmental impact. No requirement in this section will relieve the Contractor of any applicable federal, state, and local environmental protection laws and regulations. During Construction, identify, implement, and submit for approval any additional requirements to be included in the EPP. Maintain the current version onsite.

1.6.1 General Overview and Purpose

1.6.1.1 Descriptions

A brief description of each specific plan required by environmental permit or elsewhere in this Contract such as stormwater pollution prevention plan, spill control plan, solid waste management plan, air pollution control plan, contaminant prevention plan, a historical, archaeological, cultural resources, biological resources and wetlands plan, traffic control plan, Non-Hazardous Solid Waste Disposal Plan.

1.6.1.2 Duties

The duties and level of authority assigned to the person(s) on the job site who oversee environmental compliance, such as who is responsible for adherence to the EPP, who is responsible for spill cleanup and training personnel on spill response procedures, who is responsible for manifesting hazardous waste to be removed from the site (if applicable), and who is responsible for training the Contractor's environmental protection personnel.

1.6.1.3 Procedures

A copy of any standard or project-specific operating procedures that will be used to effectively manage and protect the environment on the project site.

1.6.1.4 Communications

Communication and training procedures that will be used to convey environmental management requirements to Contractor employees and

subcontractors.

1.6.1.5 Contact Information

Emergency contact information contact information (office phone number, cell phone number, and e-mail address).

1.6.2 General Site Information

1.6.2.1 Work Area

Work area plan showing the proposed activity in each portion of the area and identify the areas of limited use or nonuse. Include measures for marking the limits of use areas, including methods for protection of features to be preserved within authorized work areas and methods to control runoff and to contain materials on site, and a traffic control plan.

1.6.2.2 Documentation

A letter signed by an officer of the firm appointing the Environmental Manager and stating that person is responsible for managing and implementing the Environmental Program as described in this contract. Include in this letter the Environmental Manager's authority to direct the removal and replacement of non-conforming work.

1.6.3 Management of Natural Resources

- a. Land resources
- b. Tree protection
- c. Replacement of damaged landscape features
- d. Temporary construction

1.6.4 Protection of Historical and Archaeological Resources

- a. Objectives
- b. Methods

1.6.5 Stormwater Management and Control

- a. Ground cover
- b. Erodible soils
- c. Temporary measures
 - (1) Structural Practices
 - (2) Temporary and permanent stabilization
- d. Effective selection, implementation and maintenance of Best Management Practices (BMPs).

1.6.6 Protection of the Environment from Waste Derived from Contractor Operations

Control and disposal of solid and sanitary waste. Control and disposal of hazardous waste.

This item consist of the management procedures for hazardous waste to be generated. The elements of those procedures will coincide with the Installation Hazardous Waste Management Plan. The Contracting Officer will provide a copy of the Installation Hazardous Waste Management Plan. As a minimum, include the following:

- a. List of the types of hazardous wastes expected to be generated
- b. Procedures to ensure a written waste determination is made for appropriate wastes that are to be generated
- c. Sampling/analysis plan, including laboratory method(s) that will be used for waste determinations and copies of relevant laboratory certifications
- d. Methods and proposed locations for hazardous waste accumulation/storage (that is, in tanks or containers)
- e. Management procedures for storage, labeling, transportation, and disposal of waste (treatment of waste is not allowed unless specifically noted)
- f. Management procedures and regulatory documentation ensuring disposal of hazardous waste complies with Land Disposal Restrictions (40 CFR 268)
- g. Management procedures for recyclable hazardous materials such as lead-acid batteries, used oil, and similar
- h. Used oil management procedures in accordance with 40 CFR 279; Hazardous waste minimization procedures
- i. Plans for the disposal of hazardous waste by permitted facilities; and Procedures to be employed to ensure required employee training records are maintained.

1.6.7 Prevention of Releases to the Environment

Procedures to prevent releases to the environment

Notifications in the event of a release to the environment

1.6.8 Regulatory Notification and Permits

List what notifications and permit applications must be made. Some permits require up to 180 days to obtain. Demonstrate that those permits have been obtained or applied for by including copies of applicable environmental permits. The EPP will not be approved until the permits have been obtained.

1.6.9 Clean Air Act Compliance

1.6.9.1 Haul Route

Submit truck and material haul routes along with a Dirt and Dust Control Plan for controlling dirt, debris, and dust on Installation roadways. As a minimum, identify in the plan the subcontractor and equipment for cleaning along the haul route and measures to reduce dirt, dust, and debris from roadways.

1.6.9.2 Pollution Generating Equipment

Identify air pollution generating equipment or processes that may require federal, state, or local permits under the Clean Air Act. Determine requirements based on any current installation permits and the impacts of the project. Provide a list of all fixed or mobile equipment, machinery or operations that could generate air emissions during the project to the Installation Environmental Office (Air Program Manager).

1.6.9.3 Stationary Internal Combustion Engines

Identify portable and stationary internal combustion engines that will be supplied, used or serviced. Comply with 40 CFR 60 Subpart IIII, 40 CFR 60 Subpart JJJJ, 40 CFR 63 Subpart ZZZZ, and local regulations as applicable. At minimum, include the make, model, serial number, manufacture date, size (engine brake horsepower), and EPA emission certification status of each engine. Maintain applicable records and log hours of operation and fuel use. Logs must include reasons for operation and delineate between emergency and non-emergency operation.

1.6.9.4 Air Pollution-engineering Processes

Identify planned air pollution-generating processes and management control measures (including, but not limited to, spray painting, abrasive blasting, demolition, material handling, fugitive dust, and fugitive emissions). Log hours of operations and track quantities of materials used.

1.6.9.5 Compliant Materials

Provide the Government a list of SDSs for all hazardous materials proposed for use on site. Materials must be compliant with all Clean Air Act regulations for emissions including solvent and volatile organic compound contents, and applicable National Emission Standards for Hazardous Air Pollutants requirements. The Government may alter or limit use of specific materials as needed to meet installation permit requirements for emissions.

1.7 LICENSES AND PERMITS

Obtain licenses and permits required for the construction of the project and in accordance with FAR 52.236-7 Permits and Responsibilities. Notify the Government of all general use permitted equipment the Contractor plans to use on site. This paragraph supplements the Contractor's responsibility under FAR 52.236-7 Permits and Responsibilities.

1.8 ENVIRONMENTAL RECORDS BINDER

Maintain on-site a separate three-ring Environmental Records Binder and

submit at the completion of the project. Make separate parts within the binder that correspond to each submittal listed under paragraph CLOSEOUT SUBMITTALS in this section.

1.9 SOLID WASTE MANAGEMENT PERMIT

Provide the Contracting Officer with written notification of the quantity of anticipated solid waste or debris that is anticipated or estimated to be generated by construction. Include in the report the locations where various types of waste will be disposed or recycled. Include letters of acceptance from the receiving location or as applicable; submit one copy of the receiving location state and local Solid Waste Management Permit or license showing such agency's approval of the disposal plan before transporting wastes off Government property.

1.9.1 Monthly Solid Waste Disposal Report

Monthly, submit a solid waste disposal report to the Contracting Officer. For each waste, the report will state the classification (using the definitions provided in this section), amount, location, and name of the business receiving the solid waste.

PART 2 PRODUCTS

Not Used

PART 3 EXECUTION

3.1 PROTECTION OF NATURAL RESOURCES

Minimize interference with, disturbance to, and damage to fish, wildlife, and plants, including their habitats. Prior to the commencement of activities, consult with the Installation Environmental Office, regarding rare species or sensitive habitats that need to be protected. The protection of rare, threatened, and endangered animal and plant species identified, including their habitats, is the Contractor's responsibility.

Preserve the natural resources within the project boundaries and outside the limits of permanent work. Restore to an equivalent or improved condition upon completion of work that is consistent with the requirements of the Installation Environmental Office or as otherwise specified. Confine construction activities to within the limits of the work indicated or specified.

3.1.1 Flow Ways

Do not alter water flows or otherwise significantly disturb the native habitat adjacent to the project and critical to the survival of fish and wildlife, except as specified and permitted.

3.1.2 Vegetation

Except in areas to be cleared, do not remove, cut, deface, injure, or destroy trees or shrubs without the Contracting Officer's permission. Do not fasten or attach ropes, cables, or guys to existing nearby trees for anchorages unless authorized by the Contracting Officer. Where such use of attached ropes, cables, or guys is authorized, the Contractor is responsible for any resultant damage.

Protect existing trees that are to remain to ensure they are not injured, bruised, defaced, or otherwise damaged by construction operations. Remove displaced rocks from uncleared areas. Coordinate with the Contracting Officer and Installation Environmental Office to determine appropriate action for trees and other landscape features scarred or damaged by equipment operations.

3.1.3 Streams

Stream crossings must allow movement of materials or equipment without violating water pollution control standards of the federal, state, and local governments. Construction of stream crossing structures must be in compliance with any required permits including, but not limited to, Clean Water Act Section 404, and Section 401 Water Quality.

The Contracting Officer's approval and appropriate permits are required before any equipment will be permitted to ford live streams. In areas where frequent crossings are required, install temporary culverts or bridges. Obtain Contracting Officer's approval prior to installation. Remove temporary culverts or bridges upon completion of work, and repair the area to its original condition unless otherwise required by the Contracting Officer.

3.2 STORMWATER

Do not discharge stormwater from construction sites to the sanitary sewer. If the water is noted or suspected of being contaminated, it may only be released to the storm drain system if the discharge is specifically permitted. Obtain authorization in advance from the Installation Environmental Office for any release of contaminated water.

3.2.1 Erosion and Sediment Control Measures

Provide erosion and sediment control measures as indicated on the drawings. Preserve vegetation to the maximum extent practicable.

Erosion control inspection reports may be compiled as part of a stormwater pollution prevention plan inspection reports.

3.2.1.1 Sediment Control Practices

Implement sediment control practices to divert flows from exposed soils, temporarily store flows, or otherwise limit runoff and the discharge of pollutants from exposed areas of the site. Implement sediment control practices prior to soil disturbance and prior to creating areas with concentrated flow, during the construction process to minimize erosion and sediment laden runoff. Include the following devices: storm drain inlet protection and silt socks. Location and details of installation and construction are indicated on the drawings.

3.2.2 Work Area Limits

Mark the areas that need not be disturbed under this Contract prior to commencing construction activities. Mark or fence isolated areas within the general work area that are not to be disturbed. Protect monuments and markers before construction operations commence. Where construction operations are to be conducted during darkness, any markers must be visible in the dark. Personnel must be knowledgeable of the purpose for marking and protecting particular objects.

3.2.3 Contractor Facilities and Work Areas

Place field offices, staging areas, stockpile storage, and temporary buildings in areas designated on the drawings or as directed by the Contracting Officer. Move or relocate the Contractor facilities only when approved by the Government. Provide erosion and sediment controls for onsite borrow and spoil areas to prevent sediment from entering nearby waters. Control temporary excavation and embankments for plant or work areas to protect adjacent areas.

3.2.4 Municipal Separate Storm Sewer System (MS4) Management

Comply with the Installation's MS4 permit requirements.

3.3 SURFACE AND GROUNDWATER

3.3.1 Waters of the United States

Do not enter, disturb, destroy, or allow discharge of contaminants into waters of the United States except as authorized herein. The protection of waters of the United States shown on the drawings in accordance with paragraph LICENSES AND PERMITS is the Contractor's responsibility. Authorization to enter specific waters of the United States identified does not relieve the Contractor from any obligation to protect other waters of the United States within, adjacent to, or in the vicinity of the construction site and associated boundaries.

3.4 PROTECTION OF CULTURAL RESOURCES

3.4.1 Archaeological Resources

If, during excavation or other construction activities, any previously unidentified or unanticipated historical, archaeological, and cultural resources are discovered or found, activities that may damage or alter such resources will be suspended. Resources covered by this paragraph include, but are not limited to: any human skeletal remains or burials; artifacts; shell, midden, bone, charcoal, or other deposits; rock or coral alignments, pavings, wall, or other constructed features; and any indication of agricultural or other human activities. Upon such discovery or find, immediately notify the Contracting Officer so that the appropriate authorities may be notified and a determination made as to their significance and what, if any, special disposition of the finds should be made. Cease all activities that may result in impact to or the destruction of these resources. Secure the area and prevent employees or other persons from trespassing on, removing, or otherwise disturbing such resources. The Government retains ownership and control over archaeological resources.

3.5 AIR RESOURCES

Equipment operation, activities, or processes will be in accordance with 40 CFR 64 and state air emission and performance laws and standards.

3.5.1 Burning

Burning is prohibited on the Government premises.

3.5.2 Dust Control

Keep dust down at all times, including during nonworking periods. Sprinkle or treat, with dust suppressants, the soil at the site, haul roads, and other areas disturbed by operations. Dry power brooming will not be permitted. Instead, use vacuuming, wet mopping, wet sweeping, or wet power brooming. Air blowing will be permitted only for cleaning nonparticulate debris such as steel reinforcing bars. Only wet cutting will be permitted for cutting concrete blocks, concrete, and bituminous concrete. Do not unnecessarily shake bags of cement, concrete mortar, or plaster. Since these products contain Crystalline Silica, comply with the applicable OSHA standard, 29 CFR 1910.1053 or 29 CFR 1926.1153 for controlling exposure to Crystalline Silica Dust.

3.5.2.1 Particulates

Dust particles, aerosols and gaseous by-products from construction activities, and processing and preparation of materials (such as from asphaltic batch plants) must be controlled at all times, including weekends, holidays, and hours when work is not in progress. Maintain excavations, stockpiles, haul roads, permanent and temporary access roads, plant sites, spoil areas, borrow areas, and other work areas within or outside the project boundaries free from particulates that would exceed 40 CFR 50, state, and local air pollution standards or that would cause a hazard or a nuisance. Sprinkling, chemical treatment of an approved type, baghouse, scrubbers, electrostatic precipitators, or other methods will be permitted to control particulates in the work area. Sprinkling, to be efficient, must be repeated to keep the disturbed area damp. Provide sufficient, competent equipment available to accomplish these tasks. Perform particulate control as the work proceeds and whenever a particulate nuisance or hazard occurs. Comply with state and local visibility regulations.

3.5.2.2 Abrasive Blasting

Blasting operations cannot be performed without prior approval of the Installation Air Program Manager. The use of silica sand is prohibited in sandblasting.

Provide tarpaulin drop cloths and windscreens to enclose abrasive blasting operations to confine and collect dust, abrasive agent, paint chips, and other debris.

3.5.3 Odors

Control odors from construction activities. The odors must be in compliance with state regulations and local ordinances and may not constitute a health hazard.

3.6 WASTE MINIMIZATION

Minimize the use of hazardous materials and the generation of waste. Include procedures for pollution prevention/ hazardous waste minimization in the Hazardous Waste Management Section of the EPP. Obtain a copy of the installation's Pollution Prevention/Hazardous Waste Minimization Plan for reference material when preparing this part of the EPP. If no written plan exists, obtain information by contacting the Contracting Officer. Describe the anticipated types of the hazardous materials to be used in the construction when requesting information.

3.6.1 Salvage, Reuse and Recycle

Identify anticipated materials and waste for salvage, reuse, and recycling. Describe actions to promote material reuse, resale or recycling. To the extent practicable, all scrap metal must be sent for reuse or recycling and will not be disposed of in a landfill.

Include the name, physical address, and telephone number of the hauler, if transported by a franchised solid waste hauler. Include the destination and, unless exempted, provide a copy of the state or local permit (cover) or license for recycling.

3.6.2 Nonhazardous Solid Waste Diversion Report

Maintain an inventory of nonhazardous solid waste diversion and disposal of construction and demolition debris. Submit a report to the Contracting Officer on the first working day after each fiscal year quarter, starting the first quarter that nonhazardous solid waste has been generated. Include the following in the report:

Construction and Demolition (C&D) Debris Disposed	tons as appropriate
C&D Debris Recycled	tons as appropriate
C&D Debris Composted	tons as appropriate
Total C&D Debris Generated	tons as appropriate
Waste Sent to Waste-To-Energy Incineration Plant (This amount should not be included in the recycled amount)	tons as appropriate

3.7 WASTE MANAGEMENT AND DISPOSAL

3.7.1 Waste Determination Documentation

Complete a Waste Determination form (provided at the pre-construction conference) for Contractor-derived wastes to be generated. All potentially hazardous solid waste streams that are not subject to a specific exclusion or exemption from the hazardous waste regulations (e.g. scrap metal, domestic sewage) or subject to special rules, (lead-acid batteries and precious metals) must be characterized in accordance with the requirements of 40 CFR 261 or corresponding applicable state or local regulations. Base waste determination on user knowledge of the processes and materials used, and analytical data when necessary. Consult with the Installation environmental staff for guidance on specific requirements. Attach support documentation to the Waste Determination form. As a minimum, provide a Waste Determination form for the following waste (this listing is not inclusive): oil- and latex -based painting and caulking products, solvents, adhesives, aerosols, petroleum products, and containers of the original materials.

3.7.2 Solid Waste Management

3.7.2.1 Project Solid Waste Disposal Documentation Report

Provide copies of the waste handling facilities' weight tickets, receipts, bills of sale, and other sales documentation. In lieu of sales documentation, a statement indicating the disposal location for the solid waste that is signed by an employee authorized to legally obligate or bind the firm may be submitted. The sales documentation must include the receiver's tax identification number and business, EPA or state registration number, along with the receiver's delivery and business addresses and telephone numbers. For each solid waste retained for the Contractor's own use, submit the information previously described in this paragraph on the solid waste disposal report. Prices paid or received do not have to be reported to the Contracting Officer unless required by other provisions or specifications of this Contract or public law.

3.7.2.2 Control and Management of Solid Wastes

Pick up solid wastes, and place in covered containers that are regularly

emptied. Do not prepare or cook food on the project site. Prevent contamination of the site or other areas when handling and disposing of wastes. At project completion, leave the areas clean. Employ segregation measures so that no hazardous or toxic waste will become co-mingled with non-hazardous solid waste. Transport solid waste off Government property and dispose of it in compliance with 40 CFR 260, state, and local requirements for solid waste disposal. A Subtitle D RCRA permitted landfill is the minimum acceptable offsite solid waste disposal option. Verify that the selected transporters and disposal facilities have the necessary permits and licenses to operate. Solid waste disposal offsite must comply with most stringent local, state, and federal requirements, including 40 CFR 241, 40 CFR 243, and 40 CFR 258.

Manage hazardous material used in construction, including but not limited to, aerosol cans, waste paint, cleaning solvents, contaminated brushes, and used rags, in accordance with 49 CFR 173.

3.7.3 Control and Management of Hazardous Waste

Do not dispose of hazardous waste on Government property. Do not discharge any waste to a sanitary sewer, storm drain, or to surface waters or conduct waste treatment or disposal on Government property without written approval of the Contracting Officer.

3.7.3.1 Hazardous Waste/Debris Management

Identify construction activities that will generate hazardous waste or debris. Provide a documented waste determination for resultant waste streams. Identify, label, handle, store, and dispose of hazardous waste or debris in accordance with federal, state, and local regulations, including 40 CFR 261, 40 CFR 262, 40 CFR 263, 40 CFR 264, 40 CFR 265, 40 CFR 266, and 40 CFR 268.

Manage hazardous waste in accordance with the approved Hazardous Waste Management Section of the EPP. Store hazardous wastes in approved containers in accordance with 49 CFR 173 and 49 CFR 178. Hazardous waste generated within the confines of Government facilities is identified as being generated by the Government. Prior to removal of any hazardous waste from Government property, hazardous waste manifests must be signed by personnel from the Installation Environmental Office. Do not bring hazardous waste onto Government property. Provide the Contracting Officer with a copy of waste determination documentation for any solid waste streams that have any potential to be hazardous waste or contain any chemical constituents listed in 40 CFR 372-SUBPART D.

3.7.3.2 Disposal Documentation for Hazardous and Regulated Waste

Contact the Contracting Officer for the facility RCRA identification number that is to be used on each manifest.

3.7.4 Releases/Spills of Oil and Hazardous Substances

3.7.4.1 Response and Notifications

Exercise due diligence to prevent, contain, and respond to spills of hazardous material, hazardous substances, hazardous waste, sewage, regulated gas, petroleum, lubrication oil, and other substances regulated in accordance with 40 CFR 300. Maintain spill cleanup equipment and materials at the work site. In the event of a spill, take prompt,

effective action to stop, contain, curtail, or otherwise limit the amount, duration, and severity of the spill/release. In the event of any releases of oil and hazardous substances, chemicals, or gases; immediately (within 15 minutes) notify the Installation Fire Department, the Installation Command Duty Officer, the Installation Environmental Office, the Contracting Officer.

Submit verbal and written notifications as required by the federal (40 CFR 300.125 and 40 CFR 355), state, local regulations and instructions. Provide copies of the written notification and documentation that a verbal notification was made within 20 days. Spill response must be in accordance with 40 CFR 300 and applicable state and local regulations. Contain and clean up these spills without cost to the Government.

3.7.4.2 Clean Up

Clean up hazardous and non-hazardous waste spills. Reimburse the Government for costs incurred including sample analysis materials, clothing, equipment, and labor if the Government will initiate its own spill cleanup procedures, for Contractor- responsible spills, when: Spill cleanup procedures have not begun within one hour of spill discovery/occurrence; or, in the Government's judgment, spill cleanup is inadequate and the spill remains a threat to human health or the environment.

3.7.5 Mercury Materials

Immediately report to the Environmental Office and the Contracting Officer instances of breakage or mercury spillage. Clean mercury spill area to the satisfaction of the Contracting Officer.

Do not recycle a mercury spill cleanup; manage it as a hazardous waste for disposal.

3.7.6 Wastewater

3.7.6.1 Disposal of Wastewater

Disposal of wastewater must be as specified below.

3.7.6.1.1 Treatment

Do not allow wastewater from construction activities, such as onsite material processing, concrete curing, foundation and concrete clean-up, water used in concrete trucks, and forms to enter water ways or to be discharged prior to being treated to remove pollutants. Dispose of the construction-related waste water off-Government property in accordance with 40 CFR 403, state, regional, and local laws and regulations.

3.8 PREVIOUSLY USED EQUIPMENT

Clean previously used construction equipment prior to bringing it onto the project site. Equipment must be free from soil residuals, egg deposits from plant pests, noxious weeds, and plant seeds. Consult with the U.S. Department of Agriculture jurisdictional office for additional cleaning requirements.

3.9 POST CONSTRUCTION CLEANUP

Clean up areas used for construction in accordance with Contract Clause: "Cleaning Up". Unless otherwise instructed in writing by the Contracting Officer, remove traces of temporary construction facilities such as haul roads, work area, structures, foundations of temporary structures, stockpiles of excess or waste materials, and other vestiges of construction prior to final acceptance of the work. Grade parking area and similar temporarily used areas to conform with surrounding contours.

PART 4 Attachments

Attachment A: Contractor Requirements Compliance

Attachment B: Contractor Requirements Conservation

-- End of Section --

HIARNG ENVIRONMENTAL CONTRACTOR REQUIREMENTS

PROJECT NAME:	
PROJECT NUMBER:	SUBMISSION DATE:
REVIEWER: HIARNG Environmental Compliance Office (ENV), ng.hi.hiarng.list.nghi-env-comp@mail.mil	DATE REVIEWED:
	DATE RECEIVED:

NO.	REQUIREMENT
1	<p>Compliance. The Contractor shall follow all Federal, State, City and County laws, regulations, and permits, as well as applicable Department of Defense (DOD), Army, and Hawaii Army National Guard (HIARNG) plans and policies. Payment of any fines or penalties resulting from the Contractor's operations is the responsibility of the Contractor.</p>
2	<p>Hazardous Materials.</p> <p>a. Hazardous Materials Inventory. In order to facilitate annual Hawaii Emergency Planning and Community Right-to-Know Act (HEPCRA) reporting requirements, prior to project start, Contractor shall submit to the Hawaii Army National Guard (HIARNG) Environmental Office (ENV) a list of hazardous materials and quantities anticipated to be used for the project, including chemical products, fuel, asphalt, etc., and provide actual amounts within 30 days of project completion. For on-going projects, provide an update no later than 31 January of each calendar year. The log shall include the product name, manufacturer, product identification number, container size, amount used, and maximum number of containers to be stored on-site at any given day during the project (sample form attached). Upon request and site visit, ENV may waive this requirement for containers 5 gallons or less.</p> <p>b. Storage. Contractor shall only store hazardous materials for immediate use on-site; no long-term storage shall be permitted. All liquid hazardous materials shall be stored in covered areas and in secondary containment capable of containing the contents of the largest container.</p> <p>c. Safety Data Sheets (SDSs). SDSs for all chemical products shall be made available to ENV upon request.</p>
3	<p>Regulated Waste. If the Contractor will or may generate hazardous waste, universal waste (batteries, fluorescent lamps and other types of lamps, etc.), other regulated waste (e.g., asbestos, lead paint waste, polychlorinated biphenyl (PCB) light ballasts, etc.), or waste that requires laboratory analyses to determine if the waste is regulated:</p> <p>a. Information Required Prior to Project Start. Contractor shall provide to ENV:</p> <p style="margin-left: 20px;">i. An estimate of the maximum amount of each type of waste to be generated per month, and the total amount anticipated to be stored on-site at any given time.</p> <p style="margin-left: 20px;">ii. The names and EPA ID numbers of the disposal/recycling facilities and transporters to be used, which shall be listed on the Defense Logistics Agency (DLA) Disposition Services (DS) lists of Qualified Facilities and Qualified Transporters at http://www.dla.mil/DispositionServices/Offers/Disposal/HazardousWaste/HazWasteDisposal.aspx</p> <p>b. Sampling and Analyses. Contractor shall notify ENV prior to any sampling and analyses required to properly characterize the waste, and shall use a NELAC-approved laboratory. Contractor shall provide copies of all test reports within 5 workdays of receipt, along with any associated documents used to characterize the waste.</p> <p>c. Waste Management. Contractor shall mark/label, store, manage, and transport all waste in accordance with all applicable Federal, State, and local regulations; and pending shipment, store the waste in a secured area approved by ENV.</p> <p>d. Monthly Waste Generation Reports. Contractor shall submit monthly waste generation reports to ENV within 5 days after the end of each month. The reports shall indicate the type of waste and number of pounds of each type generated in the month being reported and totals stored on-site (sample form attached).</p> <p>e. Waste Manifests. Contractor shall submit draft copies of waste manifests to ENV for review at least 5 workdays prior to shipment off-site. The applicable HIARNG EPA ID Number shall be used on waste manifests, and manifests shall only be signed by authorized ENV staff personnel.</p>

	<p>f. Waste Disposal Costs. Contractor shall pay for all disposal/recycling costs for waste generated from this project, including sampling and analyses and other associated costs.</p>																		
4	<p>Spill Prevention and Response.</p> <p>a. Contractors shall establish and implement spill preventive measures, including frequent preventive maintenance checks of vehicles and equipment to prevent leaks, avoid parking equipment on unpaved areas, use of drip pans, and storing all liquid chemicals under cover and in secondary containment capable of containing the contents of the largest container.</p> <p>b. No fueling on-site is permitted without approval from ENV. Contractors storing oil or fuel on-site in containers with aggregate shell capacity totaling greater than 1,320 gallons (regardless of actual amount stored) shall prepare Spill Prevention, Control, and Countermeasures (SPCC) Plan in accordance with 40 CFR 112 <i>Oil Pollution Prevention</i> and shall submit a copy of the plan to ENV prior to project start.</p> <p>c. Contractors shall ensure adequate spill supplies are maintained on-site and readily available near areas with potential for spills or leaks.</p> <p>d. Contractor shall post emergency contact sign at project site indicating the name and phone number for the government Project Manager, the contractor emergency contact, police/fire department 911, and HIARNG ENV 672-1013.</p> <p>e. Contractor shall report all spills immediately to the HIARNG Project Manager and ENV at 672-1013, and shall complete and submit the HIARNG Spill Incident Report Form to ENV within 72 hours.</p> <p>f. Contractor shall immediately clean up all spills IAW Federal and State guidelines, and to the satisfaction of ENV. Contractor shall accomplish all regulatory verbal and written notifications to the Hawaii Department of Health (DOH), Local Emergency Planning Committee (LEPC), National Response Center (NRC), and/or the Environmental Protection Agency (EPA), as applicable, and provide ENV copies of all spill reports submitted.</p>																		
5	<p>Storm Water. Contractors shall initiate and maintain practices and measures to prevent contamination of storm water throughout all phases of work regardless of project size, and shall comply with HIARNG Construction, Repair, and Maintenance Storm Water Best Management Practices Manual, and HIARNG Storm Water Management Plan.</p>																		
6	<p>Permits. Contractor shall be responsible for assessing whether the project and/or project activities require environmental governmental permits/approvals (e.g., for oil/water separators, grease traps, septic tanks, underground injection control (UIC) wells, industrial storm water discharge, etc.) and are responsible for obtaining, implementing and complying with all applicable permit requirements.</p> <p>a. Contractor shall provide to ENV prior to project start, copies of all permit applications, permits, approvals, and associated required plans.</p> <p>b. Projects that disturb more than 1 acre of soil, including projects that, considered with other related projects, cumulatively disturb more than 1 acre of soil, are required to obtain an applicable National Pollutant Discharge Elimination System (NPDES) storm water discharge permit from DOH, and comply with all permit requirements, including preparation of plans and conducting inspections. Sites less than 1 acre are required to implement best management practices (BMPs) to prevent contaminated storm water from leaving the site.</p>																		
7	<p>Solid Waste. Contractor shall submit to HIARNG Project Manager data for construction and demolition non-hazardous recycled/diverted waste (i.e., waste that does not go into the landfill or H-POWER) and non-hazardous disposed waste (waste that goes to landfill or H-POWER). Include the weight with its individual associated ticket number. Data can be provided by any means (e.g. receipt copies, Excel table, email message) Data should include:</p> <table border="1" data-bbox="293 1549 1393 1772"> <thead> <tr> <th>REQUIRED DATA</th> <th>RECYCLED/DIVERTED WASTE</th> <th>DISPOSED WASTE</th> </tr> </thead> <tbody> <tr> <td>Ticket #</td> <td></td> <td></td> </tr> <tr> <td>Type of Material</td> <td></td> <td></td> </tr> <tr> <td>Net Weight</td> <td></td> <td></td> </tr> <tr> <td>Recycle/Disposal Facility</td> <td></td> <td></td> </tr> <tr> <td>Cost(C)/(R)Revenue Amount</td> <td>C <input type="checkbox"/> R <input type="checkbox"/></td> <td>N/A</td> </tr> </tbody> </table>	REQUIRED DATA	RECYCLED/DIVERTED WASTE	DISPOSED WASTE	Ticket #			Type of Material			Net Weight			Recycle/Disposal Facility			Cost(C)/(R)Revenue Amount	C <input type="checkbox"/> R <input type="checkbox"/>	N/A
REQUIRED DATA	RECYCLED/DIVERTED WASTE	DISPOSED WASTE																	
Ticket #																			
Type of Material																			
Net Weight																			
Recycle/Disposal Facility																			
Cost(C)/(R)Revenue Amount	C <input type="checkbox"/> R <input type="checkbox"/>	N/A																	

ENVIRONMENTAL SOW REQUIREMENTS:

NATIONAL ENVIRONMENTAL POLICY ACT & HRS 343:

All federal and state undertakings must have National Environmental Policy Act (NEPA) or Hawaii Revised Statutes Chapter 343 Environmental Impact Statements (HEPA) analysis and documentation on file prior to construction commencing and funds being executed for construction projects. It is Army National Guard Policy that NEPA/HEPA analysis and documentation must be completed before or at the 30% design phase. A/E design should not proceed past 30% design without a Record of Environmental Consideration (REC) on file for federal projects or a Declaration of Exemption (DEC) for state projects. A REC or DEC can only be utilized if the project is covered by a Categorical Exclusion, as listed in Appendix B of 32 CFR Part 651 or an Exemption, as listed in the State of Hawaii, Department of Defense Exemption List. In order to complete a REC or DEC, the HIARNG Environmental Office must consult with the State Historic Preservation Division (SHPD) for projects involving ground disturbance and/or historic buildings. The HIARNG Environmental office must consult with the U.S. Fish and Wildlife Service (USFWS) for any project that may affect a threatened or endangered species.

If it is determined that the project does not meet the parameters of a CATEX or State of Hawaii, Department of Defense Exemption, the design shall not proceed past 30% without a contract for an Environmental Assessment in place.

NATIONAL HISTORIC PRESERVATION ACT:

Historic Buildings:

The contractor is to provide a project summary to the Hawaii Army National Guard (HIARNG) Cultural Resources Specialist (CRS) for a project that involves renovation, maintenance, or changes to a historic building. The project summary shall include a brief project description with any and all construction work that may alter the integrity of a historic building, including design drawings and photographs of existing conditions. All construction activities shall follow the US Department of the Interior: Secretary of the Interior's Standards for Rehabilitation (36 CFR Part 67) and Guidelines for Rehabilitating Historic Buildings. The project summary provided to the CRS will be referenced in a letter to the State Historic Preservation Division (SHPD). The SHPD will have 30 days to review the project and submit their comments to the HIARNG. The POC for the project summary is Mr. Kekapala Dye, Kekapala.dye@hawaii.gov. Contractor is to cc the Project Manager on any correspondence with the CRS regarding historic building project summaries. This correspondence follows the National Historic Preservation Act (NHPA) Section 106 guidelines for federal undertakings as well as the Hawaii Revised Statutes Chapter 6E guidelines for state actions.

Ground Disturbance:

The contractor is to provide a project summary to the Hawaii Army National Guard (HIARNG) Cultural Resources Specialist (CRS) for a project that involves ground disturbance. The project summary shall include a thorough description of the overall project, including total square footage of ground disturbance and dimensions of ground disturbance, including maximum depth/width/length. Digging can include trenching, grading, concrete foundation preparation work, bollard installation and other forms of ground disturbance. The project summary shall include DWG design & construction drawings as well as the associated geo-referenced site plan. The project summary and DWG files provided to the CRS will be referenced in a letter to the State Historic Preservation Division (SHPD). The SHPD will have 30 days to review the project and submit their comments to the HIARNG. The POC for the project summary is Mr. Kekapala Dye, Kekapala.dye@hawaii.gov. Contractor is to cc the Project Manager on any correspondence with the CRS regarding ground disturbance project summaries. This correspondence follows the National Historic Preservation Act (NHPA) Section 106 guidelines for federal undertakings as well as the Hawaii Revised Statutes Chapter 6E guidelines for state actions.

An Archaeological Monitoring Plan (AMP) may be required by the SHPD prior to the commencement of ground disturbing activities. The AMP shall follow Hawai'i Revised Statutes (HRS) Chapter 6E, and the implementing HAR 13-279-5 requirements. A separate contract will be coordinated if an AMP is required by the SHPD.

HAWAII REVISED STATUTES 6E-43.6 & HAWAII ADMINISTRATIVE RULES 13-300

Inadvertent Discovery of Burial Sites

A. Inadvertent burial site and/or human remains shall be handled in accordance with the provisions outlined in HRS 6E-43.6 and HAR 13-300. In the event that human skeletal remains are inadvertently discovered, all activity in the immediate area shall cease and the HIARNG CRS will report the discovery to the SHPD, the appropriate medical examiner or coroner, and the police department. The SHPD will notify the Oahu Island Burial Council and The Office of Hawaiian Affairs (OHA) of the discovery. Within two (2) working days a medical examiner and a qualified archaeologist shall examine the skeletal remains to determine jurisdiction.

B. Inadvertent non-burial finds shall be handled in accordance with the provisions outlined in HAR 13-280. In the event that historic properties are inadvertently discovered, all activity in the immediate area shall cease, no items shall be moved and the HIARNG CRS will notify the SHPD as soon as possible. The find(s) will be secured and protected by State Parks.

ENDANGERED SPECIES ACT & MIGRATORY BIRD TREATY ACT:

The contractor is to provide a project summary to the Hawaii Army National Guard (HIARNG) Natural Area Reserves Specialist Supervisor for a project that involves erecting fencing, downing of trees, installing exterior lighting, night time construction, planting of new vegetation, cutting of trees and construction activities during breeding season of the Hawaiian Nene (December-April), Hawaiian Hawk (March – September) and/or Hawaiian Hoary Bat (June - September). The project summary shall include a brief project description with any and all construction work that may affect threatened, endangered, candidate species, species of concern and/or critical habitat, including design drawings and photographs of existing conditions. The project summary provided will be referenced in a letter to the U.S. Fish and Wildlife Service (USFWS) and to the State of Hawaii, Department of Forestry and Wildlife (DOFAW). The USFWS and DOFAW will have 45 days to review the project and submit their comments to the HIARNG. The POC for the project summary is Mr. Craig Blaisdell, craig.p.blaisdell.nfg@mail.mil. Contractor is to cc the Project Manager on any correspondence with the Conservation Manager regarding project summaries. This correspondence follows the Endangered Species Act (ESA) Section 7 guidelines for federal undertakings as well as the Hawaii Administrative Rules, Chapter 124 guidelines for state actions.

GIS DELIVERABLES:

The contractor is to provide DWG files of the design plans at the 30%, 60% and 100% design phases to the HIARNG GIS Specialist. The contractor shall also include a geo-referenced site plan that defines the work area, including all staging areas, utility trenching, grading, and/or other ground disturbance. The contractor shall ensure all geospatial data layers contain comprehensive metadata (FGDC Metadata Content Standard - <https://www.fgdc.gov/metadata/csdgm-standard>), spatially accurate (FGDC Positional Accuracy Standard - <https://www.fgdc.gov/standards/projects/accuracy>), and compliant with Quality Assurance Plans. The DWG files will assist the HIARNG Environmental Office in developing site maps and diagrams for ESA and NHPA consultation letter submissions. The contractor shall provide updated DWG files that represent actual construction plans, if any changes have been made after the 100% design submittal. The POC for the DWG files submission is Ms. Alexa Jacroux-Biggs, alexa.l.jacrouxbiggs.nfg@mail.mil. The contractor is to cc the Project Manager on any correspondence with the GIS Specialist regarding DWG design & construction drawings.

APPLICABLE ENVIRONMENTAL PERMITS:

The contractor is responsible to obtain all necessary building permits for the project, including environmental permits related to the Coastal Zone Management Act, Special Management Area permit from the C&C Department of Planning and Permitting (DPP). Contractor is responsible to determine if the project is located on Conservation land, including the subzone, which can be found on the Office of Conservation and Coastal Lands (OCCL) website. Contractor is responsible to determine the correct permit required for the project and develop documentation for a permit application to the OCCL. Contractor is responsible to determine if a variance permit is required for the project, which can be determined at the Land Use Commission (LUC) website. If a variance permit is needed for the project, the contractor is responsible to obtain a land use variance use permit from the LUC. These permits may be a prerequisite for obtaining a building permit from DPP.

SECTION 01 74 19

CONSTRUCTION WASTE MANAGEMENT AND DISPOSAL

PART 1 GENERAL

1.1 DEFINITIONS

1.1.1 Co-mingle

The practice of placing unrelated materials together in a single container, usually for benefits of convenience and speed.

1.1.2 Construction Waste

Waste generated by construction activities, such as scrap materials, damaged or spoiled materials, temporary and expendable construction materials, and other waste generated by the workforce during construction activities.

1.1.3 Demolition Debris/Waste

Waste generated from demolition activities, including minor incidental demolition waste materials generated as a result of Intentional dismantling of all or portions of a building, to include clearing of building contents that have been destroyed or damaged.

1.1.4 Disposal

Depositing waste in a solid waste disposal facility, usually a managed landfill, regulated in the US under the Resource Conservation and Recovery Act (RCRA).

1.1.5 Diversion

The practice of diverting waste from disposal in a landfill, by means of eliminating or minimizing waste, or reuse of materials.

1.1.6 Final Construction Waste Diversion Report

A written assertion by a material recovery facility operator identifying constituent materials diverted from disposal, usually including summary tabulations of materials, weight in short-ton.

1.1.7 Recycling

The series of activities, including collection, separation, and processing, by which products or other materials are diverted from the solid waste stream for use in the form of raw materials in the manufacture of new products sold or distributed in commerce, or the reuse of such materials as substitutes for goods made of virgin materials, other than fuel.

1.1.8 Reuse

The use of a product or materials again for the same purpose, in its

original form or with little enhancement or change.

1.1.9 Salvage

Usable, salable items derived from buildings undergoing demolition or deconstruction, parts from vehicles, machinery, other equipment, or other components.

1.1.10 Source Separation

The practice of administering and implementing a management strategy to identify and segregate unrelated waste at the first opportunity.

1.2 CONSTRUCTION WASTE (INCLUDES DEMOLITION DEBRIS/WASTE)

Divert a minimum of 60 percent by weight of the project construction waste and demolition debris/waste from the landfill. Follow applicable industry standards in the management of waste. Apply sound environmental principles in the management of waste. (1) Practice efficient waste management when sizing, cutting, and installing products and materials and (2) use all reasonable means to divert construction waste and demolition debris/waste from landfills and incinerators and to facilitate the recycling or reuse of excess construction materials.

1.3 CONSTRUCTION WASTE MANAGEMENT

Implement a construction waste management program for the project. Take a pro-active, responsible role in the management of construction construction waste, recycling process, disposal of demolition debris/waste, and require all subcontractors, vendors, and suppliers to participate in the construction waste management program. Establish a process for clear tracking, and documentation of construction waste and demolition debris/waste.

1.3.1 Implementation of Construction Waste Management Program

Develop and document how the construction waste management program will be implemented in a construction waste management plan. Submit a Construction Waste Management Plan to the Contracting Officer for approval. Construction waste and demolition debris/waste materials include un-used construction materials not incorporated in the final work, as well as demolition debris/waste materials from demolition activities or deconstruction activities. In the management of waste, consider the availability of viable markets, the condition of materials, the ability to provide material in suitable condition and in a quantity acceptable to available markets, and time constraints imposed by internal project completion mandates.

1.3.2 Oversight

The Quality Control Manager, as specified in Section 01 45 00.10 20 QUALITY CONTROL, is responsible for overseeing and documenting results from executing the construction waste management plan for the project.

1.3.3 Special Programs

Implement any special programs involving rebates or similar incentives related to recycling of construction waste and demolition debris/waste materials. Retain revenue or savings from salvaged or recycling, unless

otherwise directed. Ensure firms and facilities used for recycling, reuse, and disposal are permitted for the intended use to the extent required by federal, state, and local regulations.

1.3.4 Special Instructions

Provide on-site instruction of appropriate separation, handling, recycling, salvage, reuse, and return methods to be used by all parties at the appropriate stages of the projects. Designation of single source separating or commingling will be clearly marked on the containers.

1.3.5 Waste Streams

Delineate waste streams and characterization, including estimated material types and quantities of waste, in the construction waste management plan. Manage all waste streams associated with the project. Typical waste streams are listed below. Include additional waste streams not listed:

- a. Land Clearing Debris
- b. Asphalt
- c. Masonry and CMU
- d. Concrete
- e. Metals (e.g. banding, stud trim, ductwork, piping, rebar, roofing, other trim, steel, iron, galvanized, stainless steel, aluminum, copper, zinc, bronze, etc.)
- f. Wood (nails and staples allowed)
- g. Glass
- h. Paper
- i. Plastics (PET, HDPE, PVC, LDPE, PP, PS, Other)
- j. Gypsum
- k. Non-hazardous paint and paint cans
- l. Carpet
- m. Ceiling Tiles
- n. Insulation
- o. Beverage Containers

1.4 SUBMITTALS

Government approval is required for submittals with a "G" classification. Submittals not having a "G" classification are for information only. When used, a code following the "G" classification identifies the office that will review the submittal for the Government. Submit the following in accordance with Section 01 33 00 SUBMITTAL PROCEDURES:

SD-01 Preconstruction Submittals

Construction Waste Management Plan; G

SD-06 Test Reports

Quarterly Reports

Annual Report

SD-11 Closeout Submittals

Final Construction Waste Diversion Report; S

1.5 MEETINGS

Conduct Construction Waste Management meetings. After award of the Contract and prior to commencement of work, schedule and conduct a meeting with the Contracting Officer to discuss the proposed construction waste management plan and to develop a mutual understanding relative to the management of the construction waste management program and how waste diversion requirements will be met.

The requirements of this meeting may be fulfilled during the coordination and mutual Understanding meeting outlined in Section 01 45 00.10 20 QUALITY CONTROL. At a minimum, discuss and document waste management goals at following meetings:

- a. Preconstruction meeting.
- b. Regular site meetings.
- c. Work safety meeting (if applicable).

1.6 CONSTRUCTION WASTE MANAGEMENT PLAN

Submit Construction Waste Management Plan within 15 calendar days after notice to proceed. Revise and resubmit Construction Waste Management Plan until it receives final approval from the Contracting Officer, in order for construction to begin. Execute demolition or deconstruction activities in accordance with Section 02 41 00 DEMOLITION. Manage demolition debris/waste or deconstruction materials in accordance with the approved construction waste management plan.

An approved construction waste management plan will not relieve the Contractor of responsibility for compliance with applicable environmental regulations or meeting project cumulative waste diversion requirement. Ensure all subcontractors receive a copy of the approved Construction Waste Management Plan. The plan demonstrates how to meet the project waste diversion requirement. Also, include the following in the plan:

- a. Identify the names of individuals responsible for waste management and waste management tracking, along with roles and responsibilities on the project..
- b. Actions that will be taken to reduce solid waste generation, including coordination with subcontractors to ensure awareness and participation.
- c. Description of the regular meetings to be held to address waste management.

- d. Description of the specific approaches to be used in recycling/reuse of the various materials generated, including the areas on site and equipment to be used for processing, sorting, and temporary storage of materials.
- e. Name of landfill and/or incinerator to be used.
- f. Identification of local and regional re-use programs, including non-profit organizations such as schools, local housing agencies, and organization that accept used materials such as material exchange networks and resale stores. Include the name, location, phone number for each re-use facility identified, and provide a copy of the permit or license for each facility.
- g. List of specific materials, by type and quantity, that will be salvaged for resale, salvaged and reused on the current project, salvaged and stored for reuse on a future project, or recycled. Identify the recycling facilities by name, address, and phone number.
- h. Identification of materials that cannot be recycled or reused with an explanation or justification, to be approved by the Contracting Officer.
- i. Description of the means by which any materials identified in item (g) above will be protected from contamination.
- j. Description of the means of transportation of the recyclable materials (whether materials will be site-separated and self-hauled to designated centers, or whether mixed materials will be collected by a waste hauler and removed from the site).
- k. Copy of training plan for subcontractors and other services to prevent contamination by co-mingling materials identified for diversion and waste materials.
- l. List each supplier who deliver construction materials, in bulk, or package products in returnable containers or returnable packaging, or have take-back programs. List each program and the applicable material to actively monitor and track to assist in meeting waste diversion requirements on the project.]
- m. Identify any local jurisdiction requirements for waste management. Include those requirements, points of contact, etc.]

Distribute copies of the waste management plan to each subcontractor, Quality Control Manager , and the Contracting Officer.

1.7 RECORDS (DOCUMENTATION)

1.7.1 General

Maintain records to document the types and quantities of waste generated and diverted through re-use, recycling and/or sale to third parties; through disposal to a landfill or incinerator facility. Provide explanations for any materials not recycled, reused or sold. Collect and retain manifests, weight tickets, sales receipts, and invoices specifically identifying diverted project waste materials or disposed materials.

1.7.2 Accumulated

Maintain a running record of materials generated and diverted from landfill disposal, including accumulated diversion rates for the project. Make records available to the Contracting Officer during construction or incidental demolition activities. Provide a copy of the diversion records to the Contracting Officer upon completion of the construction, incidental demolitions or minor deconstruction activities.

1.8 REPORTS

1.8.1 General

Maintain current construction waste diversion information on site for periodic inspection by the Contracting Officer. Include in the quarterly reports, annual reports and final reports: the project name, contract information, information for waste generated, diverted and disposed of for the current reporting period and show cumulative totals for the project. Reports must identify quantities of waste by type and disposal method. Also include in each report, supporting documentation to include manifests, weigh tickets, receipts, and invoices specifically identifying the project and waste material type and weighted sum.

1.8.2 Quarterly Reporting

Provide cumulative reports at the end of each quarter (December, March, June, and September, corresponding with the federal fiscal year for reporting purposes). Submit quarterly reports not later than 15 calendar days after the preceding quarter has ended.

1.8.3 Annual Reporting

Provide a cumulative construction waste diversion report annually. Submit annual report not later than 30 calendar days after the preceding fourth quarter has ended. Provide copy of annual construction waste diversion report to the installation POC.

1.9 FINAL CONSTRUCTION WASTE DIVERSION REPORT

A Final Construction Waste Diversion Report is required at the end of the project. Provide Final Construction Waste Diversion Report 60 days prior to the Beneficial Occupancy Date (BOD).

1.10 COLLECTION

Collect, store, protect, and handle reusable and recyclable materials at the site in a manner which prevents contamination, and provides protection from the elements to preserve their usefulness and monetary value. Provide receptacles and storage areas designated specifically for recyclable and reusable materials and label them clearly and appropriately to prevent contamination from other waste materials. Keep receptacles or storage areas neat and clean.

Train subcontractors and other service providers to either separate waste streams or use the co-mingling method as described in the construction waste management plan. Handle hazardous waste and hazardous materials in accordance with applicable regulations and coordinate with Section 01 57 19

TEMPORARY ENVIRONMENTAL CONTROLS.

1.10.1 Source Separation Method

Separate waste products and materials that are recyclable from trash and sort as described below into appropriately marked separate containers and then transport to the respective recycling facility for further processing. Deliver materials in accordance with recycling or reuse facility requirements (e.g., free of dirt, adhesives, solvents, petroleum contamination, and other substances deleterious to the recycling process). Separate materials into the category types as defined in the construction waste management plan.

1.10.2 Other Methods

Other methods proposed by the Contractor may be used when approved by the Contracting Officer.

1.11 DISPOSAL

Control accumulation of waste materials and trash. Recycle or dispose of collected materials off-site at intervals approved by the Contracting Officer and in compliance with waste management procedures as described in the waste management plan.

1.11.1 Reuse

Give first consideration to reusing construction and demolition materials as a disposition strategy. Recover for reuse materials, products, and components as described in the approved construction waste management plan. Coordinate with the Contracting Officer to identify onsite reuse opportunities or material sales or donation available through Government resale or donation programs. Sale of recovered materials is not allowed on the Installation.

1.11.2 Recycle

Recycle non-hazardous construction and demolition/debris materials that are not suitable for reuse. Track rejection of contaminated recyclable materials by the recycling facility. Rejected recyclables materials will not be counted as a percentage of diversion calculation. Recycle all fluorescent lamps, HID lamps, mercury (Hg) -containing thermostats and ampoules, and PCBs-containing ballasts and electrical components as directed by the Contracting Officer. Do not crush lamps on site as this creates a hazardous waste stream with additional handling requirements.

1.11.3 Waste

Dispose by landfill or incineration only those waste materials with no practical use, economic benefit, or recycling opportunity.

1.12 ATTACHMENTS

Attachment A: Monthly Waste Generation Report

PART 2 PRODUCTS

Not used.

PART 3 EXECUTION

Not used. -- End of Section --

MONTHLY WASTE GENERATION REPORT

REPORTING MONTH/YEAR (MM/YYYY):
 CONTRACTOR NAME:
 PROJECT NUMBER & NAME
 PROJECT LOCATION:
 GOVERNMENT PROJECT MANGER NAME AND PHONE:

DATE SUBMITTED:

Submit to HIARNG Environmental Office within 5 days of end of the reporting month.

Accumulation Start Date	Accumulation End Date	Container ID Number	Contents	Category ¹	Beginning Weight (lbs.)	End-of- Month Weight (lbs.)	Waste Picked Up (lbs.)	Monthly Generation (lbs.)	NOTES

¹ HW - Hazardous Waste (e.g., lead paint chips); UW - Universal Waste (e.g., fluorescent lamps); PCB - Polychlorinated Biphenyls (e.g., light ballasts; Asbestos -ASB (e.g., asbestos tiles)

SECTION 01 78 00

CLOSEOUT SUBMITTALS

PART 1 GENERAL

1.1 DEFINITIONS

1.1.1 As-Built Drawings

As-built drawings are the marked-up drawings, maintained by the Contractor on-site, that depict actual conditions and deviations from the Contract Documents. These deviations and additions may result from coordination required by, but not limited to: contract modifications; official responses to submitted Requests for Information (RFI's); direction from the Contracting Officer; design that is the responsibility of the Contractor, and differing site conditions. Maintain the as-builts throughout construction as red-lined hard copies on site and or red-lined PDF files. These files serve as the basis for the creation of the record drawings.

1.1.2 Record Drawings

The record drawings are the final compilation of actual conditions reflected in the as-built drawings.

Produce the record drawings from the Record Model(s) and do not include annotations indicating revisions.

1.1.3 Record Model

A model reflecting approved changes during construction including red-lines, requests for information (RFI's), and contract modifications. Include updated construction phase facility/site data for components.

1.2 SOURCE DRAWING FILES

Request the full set of electronic drawings, in the source format, for Record Drawing preparation, after award and at least 30 days prior to required use.

1.2.1 Terms and Conditions

Data contained on these electronic files must not be used for any purpose other than as a convenience in the preparation of construction drawings and data for the referenced project. Any other use or reuse shall be at the sole risk of the Contractor and without liability or legal exposure to the Government. The Contractor must make no claim and waives to the fullest extent permitted by law, any claim or cause of action of any nature against the Government, its agents or sub consultants that may arise out of or in connection with the use of these electronic files. The Contractor must, to the fullest extent permitted by law, indemnify and hold the Government harmless against all damages, liabilities or costs, including reasonable attorney's fees and defense costs, arising out of or resulting from the use of these electronic files.

These electronic CAD drawing files are not construction documents. Differences may exist between the CAD files and the corresponding construction documents. The Government makes no representation regarding the accuracy or completeness of the electronic CAD files, nor does it make representation to the compatibility of these files with the Contractor hardware or software. In the event that a conflict arises between the signed and sealed construction documents prepared by the Government and the furnished Source drawing files, the signed and sealed construction documents govern. The Contractor is responsible for determining if any conflict exists. Use of these Source Drawing files does not relieve the Contractor of duty to fully comply with the contract documents, including and without limitation, the need to check, confirm and coordinate the work of all contractors for the project. If the Contractor uses, duplicates or modifies these electronic source drawing files for use in producing construction drawings and data related to this contract, remove all previous indicia of ownership (seals, logos, signatures, initials and dates).

1.3 RECORD DRAWINGS

The Government will provide pdf and or program files at the preconstruction conference that contains one set of "as-designed" electronic CAD files in the specified software and format revised to reflect all amendments and the final contract PDF drawings. The CAD files are provided to enable preparation of as-built or as-constructed drawings. If discrepancies exist between the CAD files and the contract PDF drawings, correct the CAD files to show the contract PDF drawings.

1.3.1 Variation with Contract Drawings

The electronic files provided are not part of the contract documents. If there is any discrepancy between the electronic files and the contract drawings, the contract drawings govern. The Government has no responsibility to modify any GFM due to changes in the design that occur after award.

Evaluate the content and quality of the GFM upon receipt. If major discrepancies or omissions occur in the GFM, notify the Contracting Officer and indicate the nature of such variations.

1.3.2 Data Loss, Corruption, and Error

Transfer of GFM files may result in corrupted files resulting in data loss and errors. Use of GFM files at own risk. Verify data integrity upon receipt and request a replacement if necessary. Make any adjustment in file structure, format, or software version as needed to make GFM compatible with computer systems and/or software to meet the requirements of the contract.

1.4 SUBMITTALS

Government approval is required for submittals with a "G" classification. Submittals not having a "G" classification are for information only. When used, a code following the "G" classification identifies the office that will review the submittal for the Government. Submit the following in accordance with Section 01 33 00 SUBMITTAL PROCEDURES:

SD-03 Product Data

Warranty Management Plan

Warranty Tags

Spare Parts Data

SD-08 Manufacturer's Instructions

Posted Instructions

SD-10 Operation and Maintenance Data

Operation and Maintenance Manuals; G

SD-11 Closeout Submittals

As-Built Drawings; G

Record Drawings; G

Record Model; G

As-Built Record of Equipment and Materials

Final Approved Shop Drawings; G

Construction Contract Specifications; G

Certification of EPA Designated Items; G

Certification Of USDA Designated Items; G

1.5 SPARE PARTS DATA

Submit two copies of the Spare Parts Data list.

- a. Indicate manufacturer's name, part number, and stock level required for test and balance, pre-commissioning, maintenance and repair activities. List those items that may be standard to the normal maintenance of the system.
- b. At acceptance of commissioning, ensure the required stock level is supplied as indicated in subparagraph a for maintenance and repair activities through the facilities warranty period. Provision of spare parts does not relieve the Contractor of responsibilities listed under the contract guarantee provisions.

1.6 QUALITY CONTROL

Additions and corrections to the contract drawings must be equal in quality and detail to that of the originals. Line colors, line weights, lettering, layering conventions, and symbols must be the same as the original line colors, line weights, lettering, layering conventions, and symbols.

1.7 WARRANTY MANAGEMENT

1.7.1 Warranty Management Plan

Develop a warranty management plan which contains information relevant to FAR 52.246-21 Warranty of Construction. At least 30 days before the planned pre-warranty conference, submit four sets of the warranty management plan. Include within the warranty management plan all required actions and documents to assure that the Government receives all warranties to which it is entitled. The plan narrative must contain sufficient detail to render it suitable for use by future maintenance and repair personnel, whether tradesmen, or of engineering background, not necessarily familiar with this contract. The term "status" as indicated below must include due date and whether item has been submitted or was accomplished. Submit warranty information, made available during the construction phase, to the Contracting Officer for approval prior to each monthly pay estimate. Assemble approved information in a binder and turn over to the Government upon acceptance of the work. The construction warranty period must begin on the date of project acceptance and continue for the full product warranty period. Conduct a joint 4 month and 9 month warranty inspection, measured from time of acceptance; with the Contractor, Contracting Officer and the Customer Representative. The warranty management plan must include, but is not limited to, the following:

- a. Roles and responsibilities of personnel associated with the warranty process, including points of contact and telephone numbers within the organizations of the Contractors, subcontractors, manufacturers or suppliers involved.
- b. For each warranty, the name, address, telephone number, and e-mail of each of the guarantor's representatives nearest to the project location.
- c. A list and status of delivery of Certificates of Warranty for extended warranty items, including roofs, HVAC balancing, pumps, motors, transformers, and for commissioned systems, such as fire protection and alarm systems, sprinkler systems, and lightning protection systems.
- d. As-Built Record of Equipment and Materials list for each warranted equipment, item, feature of construction or system indicating:
 - (1) Name of item.
 - (2) Model and serial numbers.
 - (3) Location where installed.
 - (4) Name and phone numbers of manufacturers or suppliers.
 - (5) Names, addresses and telephone numbers of sources of spare parts.
 - (6) Warranties and terms of warranty. Include one-year overall warranty of construction, including the starting date of warranty of construction. Items which have warranties longer than one year must be indicated with separate warranty expiration dates.
 - (7) Cross-reference to warranty certificates as applicable.
 - (8) Starting point and duration of warranty period.
 - (9) Summary of maintenance procedures required to continue the warranty in force.
 - (10) Cross-reference to specific pertinent Operation and Maintenance manuals.
 - (11) Organization, names and phone numbers of persons to call for warranty service.

(12) Typical response time and repair time expected for various warranted equipment.

- e. The plans for attendance at the 4 and 9 month post-construction warranty inspections conducted by the Government.
- f. Procedure and status of tagging of equipment covered by warranties longer than one year.
- g. Copies of instructions to be posted near selected pieces of equipment where operation is critical for warranty or safety reasons.

1.7.2 Performance Bond

The Performance Bond must remain effective throughout the construction and warranty period.

- a. In the event the Contractor fails to commence and diligently pursue any construction warranty work required, the Contracting Officer will have the work performed by others, and after completion of the work, will charge the remaining construction warranty funds of expenses incurred by the Government while performing the work, including, but not limited to administrative expenses.
- b. In the event sufficient funds are not available to cover the construction warranty work performed by the Government at the Contractor's expense, the Contracting Officer will have the right to recoup expenses from the bonding company.
- c. Following oral or written notification of required construction warranty repair work, respond in a timely manner. Written verification will follow oral instructions. Failure to respond will be cause for the Contracting Officer to proceed against the Contractor.

1.7.3 Pre-Warranty Conference

Prior to contract completion, and at a time designated by the Contracting Officer, meet with the Contracting Officer to develop a mutual understanding with respect to the requirements of this section. At this meeting, establish and review communication procedures for Contractor notification of construction warranty defects, priorities with respect to the type of defect, reasonable time required for Contractor response, and other details deemed necessary by the Contracting Officer for the execution of the construction warranty. In connection with these requirements and at the time of the Contractor's quality control completion inspection, furnish the name, telephone number and address of a licensed and bonded company which is authorized to initiate and pursue construction warranty work action on behalf of the Contractor. This point of contact must be located within the local service area of the warranted construction, be continuously available, and be responsive to Government inquiry on warranty work action and status. This requirement does not relieve the Contractor of any of its responsibilities in connection with other portions of this provision.

1.7.4 Contractor's Response to Construction Warranty Service Requirements

Following oral or written notification by the Contracting Officer, respond to construction warranty service requirements in accordance with the "Construction Warranty Service Priority List" and the three categories of

priorities listed below. Submit a report on any warranty item that has been repaired during the warranty period. Include within the report the cause of the problem, date reported, corrective action taken, and when the repair was completed. If the Contractor does not perform the construction warranty within the timeframe specified, the Government will perform the work and back charge the construction warranty payment item established.

- a. First Priority Code 1. Perform onsite inspection to evaluate situation, and determine course of action within 4 hours, initiate work within 6 hours and work continuously to completion or relief.
- b. Second Priority Code 2. Perform onsite inspection to evaluate situation, and determine course of action within 8 hours, initiate work within 24 hours and work continuously to completion or relief.
- c. Third Priority Code 3. All other work to be initiated within 3 work days and work continuously to completion or relief.

d. The "Construction Warranty Service Priority List" is as follows:

Code 1-Electrical

- (1) Power failure (entire area or any building operational after 1600 hours).
- (2) Security lights
- (3) Smoke detectors

Code 2-Electrical

- (1) Power failure (no power to a room or part of building).
- (2) Receptacle and lights (in a room or part of building).

Code 3-Electrical

Street lights.

Code 3-All other work not listed above.

1.7.5 Warranty Tags

At the time of installation, tag each warranted item with a durable, oil and water resistant tag approved by the Contracting Officer. Attach each tag with a copper wire and spray with a silicone waterproof coating. Also, submit two record copies of the warranty tags showing the layout and design. The date of acceptance and the QC signature must remain blank until the project is accepted for beneficial occupancy. Show the following information on the tag.

Type of product/material	
Model number	
Serial number	
Contract number	
Warranty period from/to	
Inspector's signature	
Construction Contractor	
Address	
Telephone number	

Warranty contact	
Address	
Telephone number	
Warranty response time	
WARNING - PROJECT PERSONNEL TO PERFORM ONLY OPERATIONAL MAINTENANCE DURING THE WARRANTY PERIOD.	

PART 2 PRODUCTS

2.1 RECORD DRAWINGS

Prepare the CAD drawing files in AutoCAD Release 2013 format.

2.2 PDF AS-BUILT FILES

Provide electronic PDF "plots" of all contract drawings sheets associated with the as-built drawing submittal. Compile and organize the PDF set to match the contract drawings.

2.3 REDLINES AND MARKUPS

Provide PDFs of the current working redlines and/or markups complying with the as-builts drawing and markup requirements contained in this specification.

2.4 AS-BUILT OR ADVANCED MODELING RE-SUBMISSION REQUIREMENTS

If elements of an as-built submittal or advanced modeling package are rejected, provide the following for each re-submission, in addition to any information required in Section 01 33 00 SUBMITTAL PROCEDURES:

- a. Re-submit all components required under paragraph As-Builts or Advanced Modeling Package, including a new Advanced Modeling Submittal Checklist and updated content in response to Government comments.
- b. Provide a copy of all Government review comments.
- c. Provide a disposition/response to each Government review comment for a back-check of the re-submission deliverable.

PART 3 EXECUTION

3.1 AS-BUILT DRAWINGS

Provide and maintain two black line print copies of the PDF contract drawings for As-Built Drawings. Maintain the as-builts throughout construction as red-lined hard copies on site or red-lined PDF files. Submit As-Built Drawings 30 days prior to Beneficial Occupancy Date (BOD).

3.1.1 Markup Guidelines

Make comments and markup the drawings complete without reference to letters, memos, or materials that are not part of the As-Built drawing.

Show what was changed, how it was changed, where item(s) were relocated and change related details. These working as-built markup prints must be neat, legible and accurate as follows:

- a. Use base colors of red, green, and blue. Color code for changes as follows:
 - (1) Special (Blue) - Items requiring special information, coordination, or special detailing or detailing notes.
 - (2) Deletions (Red) - Over-strike deleted graphic items (lines), lettering in notes and leaders.
 - (3) Additions (Green) - Added items, lettering in notes and leaders.
- b. Provide a legend if colors other than the "base" colors of red, green, and blue are used.
- c. Add and denote any additional equipment or material facilities, service lines, incorporated under As-Built Revisions if not already shown in legend.
- d. Use frequent written explanations on markup drawings to describe changes. Do not totally rely on graphic means to convey the revision.
- e. Use legible lettering and precise and clear digital values when marking prints. Clarify ambiguities concerning the nature and application of change involved.
- f. Wherever a revision is made, also make changes to related section views, details, legend, profiles, plans and elevation views, schedules, notes and call out designations, and mark accordingly to avoid conflicting data on all other sheets.
- g. For deletions, cross out all features, data and captions that relate to that revision.
- h. For changes on small-scale drawings and in restricted areas, provide large-scale inserts, with leaders to the applicable location.
- i. Indicate one of the following when attaching a print or sketch to a markup print:
 - 1) Add an entire drawing to contract drawings
 - 2) Change the contract drawing to show
 - 3) Provided for reference only to further detail the initial design.
- j. Incorporate all shop and fabrication drawings into the markup drawings.

3.1.2 As-Built Drawings Content

Keep these working as-built markup drawings current on a weekly basis and at least one set available on the jobsite at all times. Changes from the contract drawings which are made during construction or additional information which might be uncovered in the course of construction must be accurately and neatly recorded as they occur by means of details and notes. Submit the working as-built markup drawings for approval prior to

submission of each monthly pay estimate. For failure to maintain the working and final record drawings as specified herein, the Contracting Officer will withhold 10 percent of the monthly progress payment until approval of updated drawings. Show on the as-built drawings, but not limited to, the following information:

- a. The actual location, kinds and sizes of all sub-surface utility lines. In order that the location of these lines and appurtenances may be determined in the event the surface openings or indicators become covered over or obscured, show by offset dimensions to two permanently fixed surface features the end of each run including each change in direction on the record drawings. Locate valves, splice boxes and similar appurtenances by dimensioning along the utility run from a reference point. Also record the average depth below the surface of each run.
- b. The location and dimensions of any changes within the building structure.
- c. Layout and schematic drawings of electrical circuits and piping.
- d. Correct grade, elevations, cross section, or alignment of roads, earthwork, structures or utilities if any changes were made from contract plans.
- e. Changes in details of design or additional information obtained from working drawings specified to be prepared or furnished by the Contractor; including but not limited to shop drawings, fabrication, erection, installation plans and placing details, pipe sizes, insulation material, dimensions of equipment, and foundations.
- f. The topography, invert elevations and grades of drainage installed or affected as part of the project construction.
- g. Changes or Revisions which result from the final inspection.
- h. Where contract drawings or specifications present options, show only the option selected for construction on the working as-built markup drawings.
- i. If borrow material for this project is from sources on Government property, or if Government property is used as a spoil area, furnish a contour map of the final borrow pit/spoil area elevations.
- j. Systems designed or enhanced by the Contractor, such as HVAC controls, fire alarm, fire sprinkler, and irrigation systems.
- k. Changes in location of equipment and architectural features.
- l. Modifications.
- m. Actual location of anchors, construction and control joints, etc., in concrete.
- n. Unusual or uncharted obstructions that are encountered in the contract work area during construction.
- o. Location, extent, thickness, and size of stone protection particularly where it will be normally submerged by water.

3.2 RECORD DRAWING FILES

If additional drawings are required, prepare them using the specified electronic file format applying the same graphic standards specified for original drawings. The title block and drawing border to be used for any new final record drawings must be identical to that used on the contract drawings. Accomplish additions and corrections to the contract drawings using CAD files. Provide all program files and hardware necessary to prepare final PDF record drawings. The Contracting Officer will review final PDF record drawings for accuracy and return them to the Contractor for required corrections, changes, additions, and deletions.

3.2.1 Rename the CAD Drawing files

Rename the CAD Drawing files using the contract number as the Project Code field, (e.g., W91238-15-C-10A-102.DWG) as instructed in the Pre-Construction conference. Use only those renamed files for the Marked-up changes. Make all changes on the layer/level as the original item.

- a. For AutoCAD files (DWG), enter all as-built delta changes and notations on the AS-BUILT layer.
- b. When final revisions have been completed, show the wording "RECORD DRAWING AS-BUILTS" followed by the name of the Contractor in letters at least 3/16 inch high on the cover sheet drawing. Date RECORD DRAWING AS-BUILTS" drawing revisions in the revision block.
- c. Within 14 days after Government approval of all of the working record drawings for a phase of work, prepare the final CAD record drawings for that phase of work and submit PDF drawing files and two sets of prints for review and approval. The Government will promptly return one set of prints annotated with any necessary corrections. Within 14 days revise the CAD files accordingly at no additional cost and submit one set of final prints for the completed phase of work to the Government. Within 14 days of substantial completion of all phases of work, submit the final record drawing package for the entire project. Submit one set of electronic CAD files, and one set of the approved working record PDF and or programfiles with two sets of prints. The CAD files must be complete in all details and identical in form and function to the CAD drawing files supplied by the Government. Prepare AutoCAD files for transmittal using e-Transmit. Make any transactions or adjustments necessary to accomplish this. The Government reserves the right to reject any drawing files it deems incompatible with the customer's CAD system. Paper prints, drawing files and storage media submitted will become the property of the Government upon final approval. Failure to submit final record PDF drawing files, CAD files and marked prints as specified will be cause for withholding any payment due under this contract. Approval and acceptance of final record drawings must be accomplished before final payment is made.

3.3 RECORD DRAWINGS

Prepare final record drawings after the completion of each definable phase of work as listed in the Contractor Quality Control Plan (such as Foundations, Utilities, or Structural Steel as appropriate for the project). Transfer the changes from the approved working as-built markup drawings to the original electronic CAD drawing files. Modify the

as-built CAD drawing files to correctly show the features of the project as-built by bringing the working CAD drawing set into agreement with approved working as-built markup drawings, and adding such additional drawings as may be necessary. Jointly review the working as-built markup drawings with printouts from working as-built CAD drawing PDF files for accuracy and completeness. Monthly review of working as-built CAD drawing PDF file printouts must cover all sheets revised since the previous review. These PDF drawing files are part of the permanent records of this project. Any drawings damaged or lost must be satisfactorily replaced at no expense to the Government.

Drawing revisions (include within change order price the cost to change working and final record drawings to reflect revisions) and compliance with the following procedures.

- a. Follow directions in the revision for posting descriptive changes.
- b. The revision delta size must be 5/16 inch unless the area where the delta is to be placed is crowded. Use a smaller size delta for crowded areas.
- c. Place a revision delta at the location of each deletion.
- d. For new details or sections which are added to a drawing, place a revision delta by the detail or section title.
- e. For minor changes, place a revision delta by the area changed on the drawing (each location).
- f. For major changes to a drawing, place a revision delta by the title of the affected plan, section, or detail at each location.
- g. For changes to schedules or drawings, place a revision delta either by the schedule heading or by the change in the schedule.

3.3.1 Final Record Drawing Package

Submit the final record PDF and CAD drawings package for the entire project within 20 days of substantial completion of all phases of work. Submit one set of ANSI D size PDF and CAD files, two sets of ANSI D size prints and one set of the approved working record drawings. The package must be complete in all details and identical in form and function to the contract drawing files supplied by the Government.

3.4 FINAL APPROVED SHOP DRAWINGS

Submit final approved project shop drawings 30 days after transfer of the completed facility.

3.5 CONSTRUCTION CONTRACT SPECIFICATIONS

Submit final PDF file record construction contract specifications, including revisions thereto, 30 days after transfer of the completed facility.

3.6 AS-BUILT RECORD OF EQUIPMENT AND MATERIALS

Furnish one copy of preliminary record of equipment and materials used on the project 15 days prior to final inspection. This preliminary submittal

will be reviewed and returned 7 days after final inspection with Government comments. Submit Two sets of final record of equipment and materials 10 days after final inspection. Key the designations to the related area depicted on the contract drawings. List the following data:

RECORD OF DESIGNATED EQUIPMENT AND MATERIALS DATA				
Description	Specification Section	Manufacturer and Catalog, Model, and Serial Number	Composition and Size	Where Used

3.7 OPERATION AND MAINTENANCE MANUALS

Provide project operation and maintenance manuals for designated equipment and materials. Provide electronic copies of the Operation and Maintenance Manual files and one hard copy of the Operation and Maintenance Manuals. Submit to the Contracting Officer for approval within 30 calendar days of the Beneficial Occupancy Date (BOD). Update and resubmit files for final approval at BOD.

3.8 CLEANUP

Leave premises "broom clean." Clean interior and exterior glass surfaces exposed to view; remove temporary labels, stains and foreign substances; polish transparent and glossy surfaces; vacuum carpeted and soft surfaces. Clean equipment and fixtures to a sanitary condition. [Clean][Replace] filters of operating equipment. Clean debris from roofs, gutters, downspouts and drainage systems. Sweep paved areas and rake clean landscaped areas. Remove waste and surplus materials, rubbish and construction facilities from the site.

-- End of Section --

SECTION 01 78 23

OPERATION AND MAINTENANCE DATA

PART 1 GENERAL

1.1 SUBMITTALS

Government approval is required for submittals with a "G" classification. Submittals not having a "G" classification are for information only. When used, a code following the "G" classification identifies the office that will review the submittal for the Government. Submit the following in accordance with Section 01 33 00 SUBMITTAL PROCEDURES:

SD-10 Operation and Maintenance Data

O&M Database; G

Training Plan; G

Training Outline; G

Training Content; G

SD-11 Closeout Submittals

Training Video Recording; G

Validation of Training Completion; G

1.2 OPERATION AND MAINTENANCE DATA

Submit Operation and Maintenance (O&M) Data for the provided equipment, product, or system, defining the importance of system interactions, troubleshooting, and long-term preventive operation and maintenance. Compile, prepare, and aggregate O&M data to include clarifying and updating the original sequences of operation to as-built conditions. Organize and present information in sufficient detail to clearly explain O&M requirements at the system, equipment, component, and subassembly level. Include an index preceding each submittal. Submit in accordance with this section and Section 01 33 00 SUBMITTAL PROCEDURES.

1.2.1 Package Quality

Documents must be fully legible. Operation and Maintenance data must be consistent with the manufacturer's standard brochures, schematics, printed instructions, general operating procedures, and safety precautions.

1.2.2 Package Content

Provide data package content in accordance with paragraph SCHEDULE OF OPERATION AND MAINTENANCE DATA PACKAGES. Comply with the data package requirements specified in the individual technical sections, including the content of the packages and addressing each product, component, and system designated for data package submission, except as follows. Use Data Package 4 for commissioned items without a specified data package requirement in the individual technical sections. Provide a Data Package 4

instead of Data Package 1 or 2, as specified in the individual technical section, for items that are commissioned.

1.2.3 Changes to Submittals

Provide manufacturer-originated changes or revisions to submitted data if a component of an item is so affected subsequent to acceptance of the O&M Data. Submit changes, additions, or revisions required by the Contracting Officer for final acceptance of submitted data within 30 calendar days of the notification of this change requirement.

1.3 O&M DATABASE

Develop an editable, electronic spreadsheet based on the equipment in the Operation and Maintenance Manuals that contains the information required to start a preventive maintenance program. As a minimum, provide list of system equipment, location installed, warranty expiration date, manufacturer, model, and serial number.

1.4 OPERATION AND MAINTENANCE MANUAL FILE FORMAT

Assemble data packages into electronic Operation and Maintenance Manuals. Assemble each manual into a composite electronically indexed file using the most current version of Adobe Acrobat or similar software capable of producing PDF file format. Provide compact disks (CD) or data digital versatile disk (DVD) as appropriate, so that each one contains operation, maintenance and record files, project record documents, and training videos. Include a complete electronically linked operation and maintenance directory.

1.4.1 Organization

Bookmark Product and Drawing Information documents using the current version of CSI MasterFormat numbering system, and arrange submittals using the specification sections as a structure. Use CSI MasterFormat and UFGS numbers along with descriptive bookmarked titles that explain the content of the information that is being bookmarked.

1.4.2 CD or DVD Label and Disk Holder or Case

Provide the following information on the disk label and disk holder or case:

- a. Building Number
- b. Project Title
- c. Activity and Location
- d. Construction Contract Number
- e. Prepared For: (Contracting Agency)
- f. Prepared By: (Name, title, phone number and email address)
- g. Include the disk content on the disk label
- h. Date

- i. Virus scanning program used

1.5 TYPES OF INFORMATION REQUIRED IN O&M DATA PACKAGES

The following are a detailed description of the data package items listed in paragraph SCHEDULE OF OPERATION AND MAINTENANCE DATA PACKAGES.

1.5.1 Operating Instructions

Provide specific instructions, procedures, and illustrations for the following phases of operation for the installed model and features of each system:

1.5.1.1 Operator Prestart

Provide procedures required to install, set up, and prepare each system for use.

1.5.1.2 Startup, Shutdown, and Post-Shutdown Procedures

Provide narrative description for Startup, Shutdown and Post-shutdown operating procedures including the control sequence for each procedure.

1.5.1.3 Normal Operations

Provide Control Diagrams with data to explain operation and control of systems and specific equipment. Provide narrative description of Normal Operating Procedures.

1.5.1.4 Emergency Operations

Provide Emergency Procedures for equipment malfunctions to permit a short period of continued operation or to shut down the equipment to prevent further damage to systems and equipment. Provide Emergency Shutdown Instructions for fire, explosion, spills, or other foreseeable contingencies. Provide guidance and procedures for emergency operation of utility systems including required valve positions, valve locations and zones or portions of systems controlled.

1.5.1.5 Operator Service Requirements

Provide instructions for services to be performed by the operator such as lubrication, adjustment, inspection, and recording gauge readings.

1.5.1.6 Environmental Conditions

Provide a list of Environmental Conditions (temperature, humidity, and other relevant data) that are best suited for the operation of each product, component or system. Describe conditions under which the item equipment should not be allowed to run.

1.5.1.7 Operating Log

Provide forms, sample logs, and instructions for maintaining necessary operating records.

1.5.2 Preventive Maintenance

Provide the following information for preventive and scheduled maintenance

to minimize repairs for the installed model and features of each system. Include potential environmental and indoor air quality impacts of recommended maintenance procedures and materials.

1.5.2.1 Lubrication Data

Include the following preventive maintenance lubrication data, in addition to instructions for lubrication required under paragraph OPERATOR SERVICE REQUIREMENTS:

- a. A table showing recommended lubricants for specific temperature ranges and applications.
- b. Charts with a schematic diagram of the equipment showing lubrication points, recommended types and grades of lubricants, and capacities.
- c. A Lubrication Schedule showing service interval frequency.

1.5.2.2 Preventive Maintenance Plan, Schedule, and Procedures

Provide manufacturer's schedule for routine preventive maintenance, inspections, condition monitoring (predictive tests) and adjustments required to ensure proper and economical operation and to minimize repairs. Provide instructions stating when the systems should be retested. Provide manufacturer's projection of preventive maintenance work-hours on a daily, weekly, monthly, and annual basis including craft requirements by type of craft. For periodic calibrations, provide manufacturer's specified frequency and procedures for each separate operation.

- a. Define the anticipated time required to perform each of each test (work-hours), test apparatus, number of personnel identified by responsibility, and a testing validation procedure permitting the record operation capability requirements within the schedule. Provide a remarks column for the testing validation procedure referencing operating limits of time, pressure, temperature, volume, voltage, current, acceleration, velocity, alignment, calibration, adjustments, cleaning, or special system notes. Delineate procedures for preventive maintenance, inspection, adjustment, lubrication and cleaning necessary to minimize repairs.
- b. Repair requirements must inform operators how to check out, troubleshoot, repair, and replace components of the system. Include electrical and mechanical schematics and diagrams and diagnostic techniques necessary to enable operation and troubleshooting of the system after acceptance.

1.5.3 Repair

Provide manufacturer's recommended procedures and instructions for correcting problems and making repairs.

1.5.3.1 Troubleshooting Guides and Diagnostic Techniques

Provide step-by-step procedures to promptly isolate the cause of typical malfunctions. Describe clearly why the checkout is performed and what conditions are to be sought. Identify tests or inspections and test equipment required to determine whether parts and equipment may be reused or require replacement.

1.5.3.2 Wiring Diagrams and Control Diagrams

Provide point-to-point drawings of wiring and control circuits including factory-field interfaces. Provide a complete and accurate depiction of the actual job specific wiring and control work. On diagrams, number electrical and electronic wiring and pneumatic control tubing and the terminals for each type, identically to actual installation configuration and numbering.

1.5.3.3 Repair Procedures

Provide instructions and a list of tools required to repair or restore the product or equipment to proper condition or operating standards.

1.5.3.4 Removal and Replacement Instructions

Provide step-by-step procedures and a list of required tools and supplies for removal, replacement, disassembly, and assembly of components, assemblies, subassemblies, accessories, and attachments. Provide tolerances, dimensions, settings and adjustments required. Use a combination of text and illustrations.

1.5.3.5 Spare Parts and Supply Lists

Provide lists of spare parts and supplies required for repair to ensure continued service or operation without unreasonable delays. Special consideration is required for facilities at remote locations. List spare parts and supplies that have a long lead-time to obtain.

1.5.3.6 Repair Work-Hours

Provide manufacturer's projection of repair work-hours including requirements by type of craft. Identify, and tabulate separately, repair that requires the equipment manufacturer to complete or to participate.

1.5.4 Appendices

Provide information required below and information not specified in the preceding paragraphs but pertinent to the maintenance or operation of the product or equipment. Include the following:

1.5.4.1 Product Submittal Data

Provide a copy of SD-03 Product Data submittals documented with the required approval.

1.5.4.2 Certificates

Provide a copy of SD-07 Certificates submittals documented with the required approval.

1.5.4.3 Manufacturer's Instructions

Provide a copy of SD-08 Manufacturer's Instructions submittals documented with the required approval.

1.5.4.4 O&M Submittal Data

Provide a copy of SD-10 Operation and Maintenance Data submittals documented with the required approval.

1.5.4.5 Parts Identification

Provide identification and coverage for the parts of each component, assembly, subassembly, and accessory of the end items subject to replacement. Include special hardware requirements, such as requirement to use high-strength bolts and nuts. Identify parts by make, model, serial number, and source of supply to allow reordering without further identification. Provide clear and legible illustrations, drawings, and exploded views to enable easy identification of the items. When illustrations omit the part numbers and description, both the illustrations and separate listing must show the index, reference, or key number that will cross-reference the illustrated part to the listed part. Group the parts shown in the listings by components, assemblies, and subassemblies in accordance with the manufacturer's standard practice. Parts data may cover more than one model or series of equipment, components, assemblies, subassemblies, attachments, or accessories, such as typically shown in a master parts catalog.

1.5.4.6 Warranty Information

List and explain the various warranties and clearly identify the servicing and technical precautions prescribed by the manufacturers or contract documents in order to keep warranties in force. Include warranty information for primary components of the system. Provide copies of warranties required by Section 01 78 00 CLOSEOUT SUBMITTALS.

1.5.4.7 Extended Warranty Information

List all warranties for products, equipment, components, and sub-components whose duration exceeds one year. For each warranty listed, indicate the applicable specification section, duration, start date, end date, and the point of contact for warranty fulfillment. Also, list or reference the specific operation and maintenance procedures that must be performed to keep the warranty valid. Provide copies of warranties required by Section 01 78 00 CLOSEOUT SUBMITTALS.

1.5.4.8 Personnel Training Requirements

Provide information available from the manufacturers that is needed for use in training designated personnel to properly operate and maintain the equipment and systems.

1.5.4.9 Testing Equipment and Special Tool Information

Include information on test equipment required to perform specified tests and on special tools needed for the operation, maintenance, and repair of components. Provide final set points.

1.5.4.10 Testing and Performance Data

Include completed prefunctional checklists, functional performance test forms, and monitoring reports. Include recommended schedule for retesting and blank test forms. Provide final set points.

1.5.4.11 Field Test Reports and Manufacturer's Field Reports

Provide a copy of Field Test Reports (SD-06) and Manufacturer's Field Reports (SD-09) submittals documented with the required approval.

1.5.4.12 Contractor Information

Provide a list that includes the name, address, and telephone number of the General Contractor and each Subcontractor who installed the product or equipment, or system. For each item, also provide the name address and telephone number of the manufacturer's representative and service organization that can provide replacements most convenient to the project site. Provide the name, address, and telephone number of the product, equipment, and system manufacturers.

1.6 SCHEDULE OF OPERATION AND MAINTENANCE DATA PACKAGES

Provide the O&M data packages specified in individual technical sections. The information required in each type of data package follows:

1.6.1 Data Package 1

- a. Safety precautions and hazards
- b. Cleaning recommendations
- c. Maintenance and repair procedures
- d. Warranty information
- e. Extended warranty information
- f. Contractor information
- g. Spare parts and supply list

1.6.2 Data Package 2

- a. Safety precautions and hazards
- b. Normal operations
- c. Environmental conditions
- d. Lubrication data
- e. Preventive maintenance plan, schedule, and procedures
- f. Cleaning recommendations
- g. Maintenance and repair procedures
- h. Removal and replacement instructions
- i. Spare parts and supply list
- j. Parts identification
- k. Warranty information

l. Extended warranty information

m. Contractor information

1.6.3 Data Package 3

a. Safety precautions and hazards

b. Operator prestart

c. Startup, shutdown, and post-shutdown procedures

d. Normal operations

e. Emergency operations

f. Environmental conditions

g. Operating log

h. Lubrication data

i. Preventive maintenance plan, schedule, and procedures

j. Cleaning recommendations

k. Troubleshooting guides and diagnostic techniques

l. Wiring diagrams and control diagrams

m. Maintenance and repair procedures

n. Removal and replacement instructions

o. Spare parts and supply list

p. Product submittal data

q. O&M submittal data

r. Parts identification

s. Warranty information

t. Extended warranty information

u. Testing equipment and special tool information

v. Testing and performance data

w. Contractor information

x. Field test reports

1.6.4 Data Package 4

a. Safety precautions and hazards

- b. Operator prestart
 - c. Startup, shutdown, and post-shutdown procedures
 - d. Normal operations
 - e. Emergency operations
 - f. Operator service requirements
 - g. Environmental conditions
 - h. Operating log
 - i. Lubrication data
 - j. Preventive maintenance plan, schedule, and procedures
 - k. Cleaning recommendations
 - l. Troubleshooting guides and diagnostic techniques
 - m. Wiring diagrams and control diagrams
 - n. Repair procedures
 - o. Removal and replacement instructions
 - p. Spare parts and supply list
 - q. Repair work-hours
 - r. Product submittal data
 - s. O&M submittal data
 - t. Parts identification
 - u. Warranty information
 - v. Extended warranty information
 - w. Personnel training requirements
 - x. Testing equipment and special tool information
 - y. Testing and performance data
 - z. Contractor information
 - aa. Field test reports
- 1.6.5 Data Package 5
- a. Safety precautions and hazards
 - b. Operator prestart
 - c. Start-up, shutdown, and post-shutdown procedures

- d. Normal operations
- e. Environmental conditions
- f. Preventive maintenance plan, schedule, and procedures
- g. Troubleshooting guides and diagnostic techniques
- h. Wiring and control diagrams
- i. Maintenance and repair procedures
- j. Removal and replacement instructions
- k. Spare parts and supply list
- l. Product submittal data
- m. Manufacturer's instructions
- n. O&M submittal data
- o. Parts identification
- p. Testing equipment and special tool information
- q. Warranty information
- r. Extended warranty information
- s. Testing and performance data
- t. Contractor information
- u. Field test reports

PART 2 PRODUCTS

Not Used

PART 3 EXECUTION

3.1 TRAINING

Prior to acceptance of the facility by the Contracting Officer for Beneficial Occupancy, provide comprehensive training for the systems and equipment specified in the technical specifications. The training must be targeted for the building maintenance personnel, and applicable building occupants. Instructors must be well-versed in the particular systems that they are presenting. Address aspects of the Operation and Maintenance Manual submitted in accordance with Section 01 78 00 CLOSEOUT SUBMITTALS. Training must include classroom or field lectures based on the system operating requirements. The location of classroom training requires approval by the Contracting Officer.

3.1.1 Training Plan

Submit a written training plan to the Contracting Officer for approval at

least 60 calendar days prior to the scheduled training. Training plan must be approved by the Quality Control Manager (QC) prior to forwarding to the Contracting Officer. Also, coordinate the training schedule with the Contracting Officer and QC. Include within the plan the following elements:

- a. Equipment included in training
- b. Intended audience
- c. Location of training
- d. Dates of training
- e. Objectives
- f. Outline of the information to be presented and subjects covered including description
- g. Start and finish times and duration of training on each subject
- h. Methods (e.g. classroom lecture, video, site walk-through, actual operational demonstrations, written handouts)
- i. Instructor names and instructor qualifications for each subject
- j. List of texts and other materials to be furnished by the Contractor that are required to support training
- k. Description of proposed software to be used for video recording of training sessions.

3.1.2 Training Content

The core of this training must be based on manufacturer's recommendations and the operation and maintenance information. The QC is responsible for overseeing and approving the content and adequacy of the training. Spend 95 percent of the instruction time during the presentation on the OPERATION AND MAINTENANCE DATA. Include the following for each system training presentation:

- a. Start-up, normal operation, shutdown, unoccupied operation, seasonal changeover, manual operation, controls set-up and programming, troubleshooting, and alarms.
- b. Relevant health and safety issues.
- c. Discussion of how the feature or system is environmentally responsive. Advise adjustments and optimizing methods for energy conservation.
- d. Design intent.
- e. Use of O&M Manual Files.
- f. Review of control drawings and schematics.
- g. Interactions with other systems.

h. Special maintenance and replacement sources.

i. Tenant interaction issues.

3.1.3 Training Outline

Provide the Operation and Maintenance Manual Files (Bookmarked PDF) and a written course outline listing the major and minor topics to be discussed by the instructor on each day of the course to each trainee in the course. Provide the course outline 14 calendar days prior to the training.

3.1.4 Training Video Recording

Record classroom training session(s) on video. Provide to the Contracting Officer two copies of the training session(s) in DVD video recording format. Capture within the recording, in video and audio, the instructors' training presentations including question and answer periods with the attendees. The recording camera(s) must be attended by a person during the recording sessions to assure proper size of exhibits and projections during the recording are visible and readable when viewed as training.

3.1.5 Unresolved Questions from Attendees

If, at the end of the training course, there are questions from attendees that remain unresolved, the instructor must send the answers, in writing, to the Contracting Officer for transmittal to the attendees, and the training video must be modified to include the appropriate clarifications.

3.1.6 Validation of Training Completion

Ensure that each attendee at each training session signs a class roster daily to confirm Government participation in the training. At the completion of training, submit a signed validation letter that includes a sample record of training for reporting what systems were included in the training, who provided the training, when and where the training was performed, and copies of the signed class rosters. Provide two copies of the validation to the Contracting Officer, and one copy to the Operation and Maintenance Manual Preparer for inclusion into the Manual's documentation.

-- End of Section --

SECTION 02 41 00

DEMOLITION

PART 1 GENERAL

1.1 REFERENCES

The publications listed below form a part of this specification to the extent referenced. The publications are referred to within the text by the basic designation only.

AMERICAN ASSOCIATION OF STATE HIGHWAY AND TRANSPORTATION OFFICIALS
(AASHTO)

AASHTO M 145 (1991; R 2012) Standard Specification for Classification of Soils and Soil-Aggregate Mixtures for Highway Construction Purposes

AASHTO T 180 (2017) Standard Method of Test for Moisture-Density Relations of Soils Using a 4.54-kg (10-lb) Rammer and a 457-mm (18-in.) Drop

AMERICAN SOCIETY OF SAFETY PROFESSIONALS (ASSP)

ASSP A10.6 (2006) Safety & Health Program Requirements for Demolition Operations - American National Standard for Construction and Demolition Operations

U.S. NATIONAL ARCHIVES AND RECORDS ADMINISTRATION (NARA)

40 CFR 61 National Emission Standards for Hazardous Air Pollutants

49 CFR 173.301 Shipment of Compressed Gases in Cylinders and Spherical Pressure Vessels

1.2 PROJECT DESCRIPTION

1.2.1 Definitions

1.2.1.1 Demolition

Demolition is the process of wrecking or taking out any load-supporting structural member of a facility together with any related handling and disposal operations.

1.2.1.2 Demolition Plan

Demolition Plan is the planned steps and processes for managing demolition activities and identifying the required sequencing activities and disposal mechanisms.

1.2.2 Demolition

Prepare a Demolition Plan and submit proposed demolition and removal procedures for approval before work is started. Include in the plan procedures for careful removal and disposition of materials specified to be salvaged, coordination with other work in progress, a disconnection schedule of utility services, a detailed description of methods and equipment to be used for each operation and of the sequence of operations. Coordinate with Waste Management Plan in accordance with Section 01 74 19 CONSTRUCTION WASTE MANAGEMENT AND DISPOSAL. Plan shall be approved by Contracting Officer prior to work beginning.

1.2.3 General Requirements

Do not begin demolition until authorization is received from the Contracting Officer. Remove rubbish and debris from the project site; do not allow accumulations outside the building[s]. The work includes demolition, salvage of identified items and materials, and removal of resulting rubbish and debris. Remove rubbish and debris from Government property daily, unless otherwise directed. Store materials that cannot be removed daily in areas specified by the Contracting Officer.

1.3 ITEMS TO REMAIN IN PLACE

Take necessary precautions to avoid damage to existing items to remain in place, to be reused, or to remain the property of the Government. Repair or replace damaged items as approved by the Contracting Officer. Coordinate the work of this section with all other work indicated. Construct and maintain shoring, bracing, and supports as required. Ensure that structural elements are not overloaded. Increase structural supports or add new supports as may be required as a result of any cutting, removal, deconstruction, or demolition work performed under this contract. Do not overload structural elements. Provide new supports and reinforcement for existing construction weakened by demolition, deconstruction, or removal work. Repairs, reinforcement, or structural replacement require approval by the Contracting Officer prior to performing such work.

1.3.1 Existing Construction Limits and Protection

Do not disturb existing construction beyond the extent indicated or necessary for installation of new construction. Provide temporary shoring and bracing for support of building components to prevent settlement or other movement. Provide protective measures to control accumulation and migration of dust and dirt in all work areas. Remove dust, dirt, and debris from work areas daily.

1.3.2 Trees

Protect trees within the project site which might be damaged during demolition or deconstruction, and which are indicated to be left in place, by a 6 foot high fence. Erect and secure fence a minimum of 5 feet from the trunk of individual trees or follow the outer perimeter of branches or clumps of trees. Replace any tree designated to remain that is damaged during the work under this contract with like-kind or as approved by the Contracting Officer.

1.3.3 Utility Service

Maintain existing utilities indicated to stay in service and protect against damage during demolition operations. Prior to start of work, utilities serving each area of alteration or removal will be shut off by the Government and disconnected and sealed by the Contractor.

1.3.4 Facilities

Protect electrical and mechanical services and utilities. Where removal of existing utilities and pavement is specified or indicated, provide approved barricades, temporary covering of exposed areas, and temporary services or connections for electrical and mechanical utilities. Ensure that no elements determined to be unstable are left unsupported and place and secure bracing, shoring, or lateral supports as may be required as a result of any cutting, removal, or demolition work performed under this contract.

1.4 BURNING

The use of burning at the project site for the disposal of refuse and debris will not be permitted.

1.5 SUBMITTALS

Government approval is required for submittals with a "G" classification. Submittals not having a "G" classification are for information only. When used, a code following the "G" classification identifies the office that will review the submittal for the Government. Submit the following in accordance with Section 01 33 00 SUBMITTAL PROCEDURES:

SD-01 Preconstruction Submittals

Demolition Plan; G

SD-07 Certificates

Notification; G

SD-11 Closeout Submittals

Receipts

1.6 QUALITY ASSURANCE

Submit timely notification of demolition projects to Federal, State, regional, and local authorities in accordance with 40 CFR 61, Subpart M. Notify the State's environmental protection agency and the Contracting Officer in writing 10 working days prior to the commencement of work in accordance with 40 CFR 61, Subpart M. Comply with federal, state, and local hauling and disposal regulations. In addition to the requirements of the "Contract Clauses," conform to the safety requirements contained in ASSP A10.6. Comply with the Environmental Protection Agency requirements specified. Use of explosives will not be permitted.

1.6.1 Hawaii Requirements

Complete and submit Notification of Demolition and Renovation form to Federal and State authorities and Contracting Officer, postmarked or

delivered at least ten working days prior to commencement of work, in accordance with 40 CFR 61, Subpart M.

1.6.2 Dust and Debris Control

Prevent the spread of dust and debris and avoid the creation of a nuisance or hazard in the surrounding area. Do not use water if it results in hazardous or objectionable conditions such as, but not limited to, flooding, or pollution.

1.7 PROTECTION

1.7.1 Traffic Control Signs

a. Where pedestrian and driver safety is endangered in the area of removal work, use traffic barricades with flashing lights. Notify the Contracting Officer prior to beginning such work.

1.7.2 Protection of Personnel

Before, during and after the demolition work continuously evaluate the condition of the structure being demolished and take immediate action to protect all personnel working in and around the project site. No area, section, or other structural element will be allowed to be left standing without sufficient bracing, shoring, or lateral support to prevent collapse or failure while workmen remove debris or perform other work in the immediate area.

1.8 RELOCATIONS

Perform the removal and reinstallation of relocated items as indicated with workmen skilled in the trades involved. Repair or replace items to be relocated which are damaged by the Contractor with new undamaged items as approved by the Contracting Officer.

1.9 EXISTING CONDITIONS

Before beginning any demolition, survey the site and examine the drawings and specifications to determine the extent of the work. Record existing conditions in the presence of the Contracting Officer showing the condition of structures and other facilities adjacent to areas of alteration or removal. Photographs sized 4 inch will be acceptable as a record of existing conditions. It is the Contractor's responsibility to verify and document all required outages which will be required during the course of work, and to note these outages on the record document. Submit survey results.

PART 2 PRODUCTS

2.1 FILL MATERIAL

- a. Comply with excavating, backfilling, and compacting procedures for soils used as backfill material to fill basements, voids, depressions or excavations resulting from demolition of structures.
- b. Fill material shall conform to the definition of satisfactory soil material as defined in AASHTO M 145, Soil Classification Groups A-1, A-2-4, A-2-5 and A-3. In addition, fill material shall be free from roots and other organic matter, trash, debris, frozen materials, and

stones larger than 2 inches in any dimension.

- c. Proposed fill material must be sampled and tested by an approved soil testing laboratory, as follows:

Soil classification	AASHTO M 145
Moisture-density relations	AASHTO T 180, Method B or D

PART 3 EXECUTION

3.1 EXISTING FACILITIES TO BE REMOVED

Inspect and evaluate existing structures onsite for reuse. Existing construction scheduled to be removed for reuse shall be disassembled. Dismantled and removed materials are to be separated, set aside, and prepared as specified, and stored or delivered to a collection point for reuse, remanufacture, recycling, or other disposal, as specified. Materials shall be designated for reuse onsite whenever possible.

3.1.1 Structures

- a. Remove existing structures indicated to be removed. Interior walls, other than retaining walls and partitions, shall be removed to top of concrete slab on ground. Break up basement slabs to permit drainage. Remove sidewalks, curbs, gutters and street light bases as indicated.
- b. Demolish structures in a systematic manner from the top of the structure to the ground. Complete demolition work above each tier or floor before the supporting members on the lower level are disturbed. Demolish concrete and masonry walls in small sections.
- c. Locate demolition equipment throughout the structure and remove materials so as to not impose excessive loads to supporting walls, floors, or framing.

3.1.2 Utilities and Related Equipment

3.1.2.1 General Requirements

Do not interrupt existing utilities serving occupied or used facilities, except when authorized in writing by the Contracting Officer. Do not interrupt existing utilities serving facilities occupied and used by the Government except when approved in writing and then only after temporary utility services have been approved and provided. Do not begin demolition work until all utility disconnections have been made. Shut off and cap utilities for future use, as indicated.

3.1.2.2 Disconnecting Existing Utilities

Remove existing utilities, as indicated and terminate in a manner conforming to the nationally recognized code covering the specific utility and approved by the Contracting Officer. When utility lines are encountered but are not indicated on the drawings, notify the Contracting Officer prior to further work in that area. Remove meters and related equipment and deliver to a location on the station in accordance with instructions of the Contracting Officer.

3.1.3 Chain Link Fencing

Remove chain link fencing, gates and other related salvaged items scheduled for removal and transport to designated areas. Remove gates as whole units. Cut chain link fabric to the lengths indicated and store in rolls off the ground.

3.1.4 Paving and Slabs

Remove sawcut concrete and asphaltic concrete paving and slabs including aggregate base as indicated to a depth below existing adjacent grade. Provide neat sawcuts at limits of pavement removal as indicated. Pavement and slabs designated to be recycled and utilized in this project shall be moved, ground and stored as directed by the Contracting Officer. Pavement and slabs not to be used in this project shall be removed from the Installation at Contractor's expense.

3.1.5 Masonry

Sawcut and remove masonry so as to prevent damage to surfaces to remain and to facilitate the installation of new work. Where new masonry adjoins existing, the new work shall abut or tie into the existing construction as indicated. Provide square, straight edges and corners where existing masonry adjoins new work and other locations.

3.1.6 Concrete

Saw concrete along straight lines to a depth of a minimum 2 inch. Make each cut in walls perpendicular to the face and in alignment with the cut in the opposite face. Break out the remainder of the concrete provided that the broken area is concealed in the finished work, and the remaining concrete is sound. At locations where the broken face cannot be concealed, grind smooth or saw cut entirely through the concrete.

3.1.7 Structural Steel

Dismantle structural steel at field connections and in a manner that will prevent bending or damage. Salvage for recycle structural steel, steel joists, girders, angles, plates, columns and shapes. Flame-cutting torches are permitted when other methods of dismantling are not practical. Transport steel joists and girders as whole units and not dismantled. Transport structural steel shapes to a designated recycling facility, stacked according to size, type of member and length, and stored off the ground, protected from the weather.

3.1.8 Miscellaneous Metal

Salvage shop-fabricated items such as access doors and frames, steel gratings, metal ladders, wire mesh partitions, metal railings, metal windows and similar items as whole units. Salvage light-gage and cold-formed metal framing, such as steel studs, steel trusses, metal gutters, roofing and siding, metal toilet partitions, toilet accessories and similar items. Recycle scrap metal as part of demolition and deconstruction operations. Provide separate containers to collect scrap metal and transport to a scrap metal collection or recycling facility, in accordance with the Waste Management Plan.

3.1.9 Electrical Equipment and Fixtures

Salvage motors, motor controllers, and operating and control equipment that are attached to the driven equipment. Salvage wiring systems and components. Box loose items and tag for identification. Disconnect primary, secondary, control, communication, and signal circuits at the point of attachment to their distribution system.

3.1.9.1 Fixtures

Remove and salvage electrical fixtures. Salvage unprotected glassware from the fixture and salvage separately. Salvage incandescent, mercury-vapor, and fluorescent lamps and fluorescent ballasts manufactured prior to 1978, boxed and tagged for identification, and protected from breakage.

3.1.9.2 Electrical Devices

Remove and salvage switches, switchgear, transformers, conductors including wire and nonmetallic sheathed and flexible armored cable, regulators, meters, instruments, plates, circuit breakers, panelboards, outlet boxes, and similar items. Box and tag these items for identification according to type and size.

3.1.9.3 Wiring Ducts or Troughs

Remove and salvage wiring ducts or troughs. Dismantle plug-in ducts and wiring troughs into unit lengths. Remove plug-in or disconnecting devices from the busway and store separately.

3.1.9.4 Conduit and Miscellaneous Items

Salvage conduit except where embedded in concrete or masonry. Consider corroded, bent, or damaged conduit as scrap metal. Sort straight and undamaged lengths of conduit according to size and type. Classify supports, knobs, tubes, cleats, and straps as debris to be removed and disposed.

3.2 CONCURRENT EARTH-MOVING OPERATIONS

Do not begin excavation, filling, and other earth-moving operations that are sequential to demolition or deconstruction work in areas occupied by structures to be demolished or deconstructed until all demolition and deconstruction in the area has been completed and debris removed. Fill holes, open basements and other hazardous openings.

3.3 DISPOSITION OF MATERIAL

3.3.1 Title to Materials

Except for salvaged items specified in related Sections, and for materials or equipment scheduled for salvage, all materials and equipment removed and not reused or salvaged, shall become the property of the Contractor and shall be removed from Government property. Title to materials resulting from demolition and deconstruction, and materials and equipment to be removed, is vested in the Contractor upon approval by the Contracting Officer of the Contractor's demolition, deconstruction, and removal procedures, and authorization by the Contracting Officer to begin demolition and deconstruction. The Government will not be responsible for

the condition or loss of, or damage to, such property after contract award. Showing for sale or selling materials and equipment on site is prohibited.

3.3.2 Reuse of Materials and Equipment

Remove and store materials and equipment listed in the Demolition Plan indicated to be reused or relocated to prevent damage, and reinstall as the work progresses. Coordinate the re-use of materials and equipment with the re-use requirements in accordance with Section 01 74 19 CONSTRUCTION WASTE MANAGEMENT AND DISPOSAL. Capture re-use of materials in the diversion calculations for the project.

3.3.3 Salvaged Materials and Equipment

Remove materials and equipment that are listed in the Demolition Plan indicated to be removed by the Contractor and that are to remain the property of the Government, and deliver to a storage site.

- a. Salvage items and material to the maximum extent possible.
- b. Store all materials salvaged for the Contractor as approved by the Contracting Officer and remove from Government property before completion of the contract. Coordinate the salvaged materials with tracking requirements in accordance with Section 01 74 19 CONSTRUCTION WASTE MANAGEMENT AND DISPOSAL. Capture salvaged materials in the diversion calculations for the project.
- c. Remove salvaged items to remain the property of the Government in a manner to prevent damage, and packed or crated to protect the items from damage while in storage or during shipment. Items damaged during removal or storage must be repaired or replaced to match existing items. Properly identify the contents of containers.

Remove historical items in a manner to prevent damage. Deliver the following historical items to the Government for disposition: Corner stones, contents of corner stones, and document boxes wherever located on the site.

3.3.4 Transportation Guidance

Ship all ODS containers in accordance with MIL-STD-129, DLA 4145.25 (also referenced one of the following: Army Regulation 700-68, Naval Supply Instruction 4440.128C, Marine Corps Order 10330.2C, and Air Force Regulation 67-12), 49 CFR 173.301, and DOD 4000.25-1-M.

3.3.5 Unsalvageable and Non-Recyclable Material

Dispose of unsalvageable and non-recyclable noncombustible material in a sanitary fill area offsite. Dispose of unsalvageable and non-recyclable combustible material in the sanitary fill area located off the site.

3.4 CLEANUP

Remove debris and rubbish from basement and similar excavations. Remove and transport the debris in a manner that prevents spillage on streets or adjacent areas. Apply local regulations regarding hauling and disposal.

3.5 DISPOSAL OF REMOVED MATERIALS

3.5.1 Regulation of Removed Materials

Dispose of debris, rubbish, scrap, and other nonsalvageable materials resulting from removal operations with all applicable federal, state and local regulations as contractually specified in the Waste Management Plan. Storage of removed materials on the project site is prohibited.

3.5.2 Removal from Government Property

Transport waste materials removed from demolished areas, except waste soil, from Government property for legal disposal. Dispose of waste soil as directed.

3.6 REUSE OF SALVAGED ITEMS

Recondition salvaged materials and equipment designated for reuse before installation. Replace items damaged during removal and salvage operations or restore them as necessary to usable condition.

-- End of Section --

SECTION 03 30 00

CAST-IN-PLACE CONCRETE

PART 1 GENERAL

1.1 REFERENCES

The publications listed below form a part of this specification to the extent referenced. The publications are referred to within the text by the basic designation only.

AMERICAN CONCRETE INSTITUTE (ACI)

ACI 117	(2010; Errata 2011) Specifications for Tolerances for Concrete Construction and Materials and Commentary
ACI 121R	(2008) Guide for Concrete Construction Quality Systems in Conformance with ISO 9001
ACI 301	(2016) Specifications for Structural Concrete
ACI 302.1R	(2015) Guide for Concrete Floor and Slab Construction
ACI 304.2R	(2017) Guide to Placing Concrete by Pumping Methods
ACI 304R	(2000; R 2009) Guide for Measuring, Mixing, Transporting, and Placing Concrete
ACI 305R	(2010) Guide to Hot Weather Concreting
ACI 306R	(2016) Guide to Cold Weather Concreting
ACI 308.1	(2011) Specification for Curing Concrete
ACI SP-2	(2007; Abstract: 10th Edition) ACI Manual of Concrete Inspection
ACI SP-15	(2011) Field Reference Manual: Standard Specifications for Structural Concrete ACI 301-05 with Selected ACI References

AMERICAN HARDBOARD ASSOCIATION (AHA)

AHA A135.4	(1995; R 2004) Basic Hardboard
------------	--------------------------------

AMERICAN WELDING SOCIETY (AWS)

AWS D1.4/D1.4M	(2011) Structural Welding Code - Reinforcing Steel
----------------	--

ASTM INTERNATIONAL (ASTM)

ASTM A184/A184M	(2019) Standard Specification for Welded Deformed Steel Bar Mats for Concrete Reinforcement
ASTM A615/A615M	(2020) Standard Specification for Deformed and Plain Carbon-Steel Bars for Concrete Reinforcement
ASTM A934/A934M	(2016) Standard Specification for Epoxy-Coated Prefabricated Steel Reinforcing Bars
ASTM A1044/A1044M	(2016a) Standard Specification for Steel Stud Assemblies for Shear Reinforcement of Concrete
ASTM A1064/A1064M	(2017) Standard Specification for Carbon-Steel Wire and Welded Wire Reinforcement, Plain and Deformed, for Concrete
ASTM C31/C31M	(2019a) Standard Practice for Making and Curing Concrete Test Specimens in the Field
ASTM C33/C33M	(2018) Standard Specification for Concrete Aggregates
ASTM C39/C39M	(2020) Standard Test Method for Compressive Strength of Cylindrical Concrete Specimens
ASTM C42/C42M	(2020) Standard Test Method for Obtaining and Testing Drilled Cores and Sawed Beams of Concrete
ASTM C78/C78M	(2018) Standard Test Method for Flexural Strength of Concrete (Using Simple Beam with Third-Point Loading)
ASTM C94/C94M	(2020) Standard Specification for Ready-Mixed Concrete
ASTM C136/C136M	(2019) Standard Test Method for Sieve Analysis of Fine and Coarse Aggregates
ASTM C138/C138M	(2017a) Standard Test Method for Density (Unit Weight), Yield, and Air Content (Gravimetric) of Concrete
ASTM C143/C143M	(2020) Standard Test Method for Slump of Hydraulic-Cement Concrete
ASTM C150/C150M	(2020) Standard Specification for Portland Cement
ASTM C172/C172M	(2017) Standard Practice for Sampling Freshly Mixed Concrete

ASTM C173/C173M	(2016) Standard Test Method for Air Content of Freshly Mixed Concrete by the Volumetric Method
ASTM C231/C231M	(2017a) Standard Test Method for Air Content of Freshly Mixed Concrete by the Pressure Method
ASTM C260/C260M	(2010a; R 2016) Standard Specification for Air-Entraining Admixtures for Concrete
ASTM C330/C330M	(2017a) Standard Specification for Lightweight Aggregates for Structural Concrete
ASTM C494/C494M	(2019) Standard Specification for Chemical Admixtures for Concrete
ASTM C567/C567M	(2019) Determining Density of Structural Lightweight Concrete
ASTM C618	(2019) Standard Specification for Coal Fly Ash and Raw or Calcined Natural Pozzolan for Use in Concrete
ASTM C803/C803M	(2018) Standard Test Method for Penetration Resistance of Hardened Concrete
ASTM C873/C873M	(2015) Standard Test Method for Compressive Strength of Concrete Cylinders Cast in Place in Cylindrical Molds
ASTM C900	(2015) Standard Test Method for Pullout Strength of Hardened Concrete
ASTM C989/C989M	(2018a) Standard Specification for Slag Cement for Use in Concrete and Mortars
ASTM C1017/C1017M	(2013; E 2015) Standard Specification for Chemical Admixtures for Use in Producing Flowing Concrete
ASTM C1074	(2019) Standard Practice for Estimating Concrete Strength by the Maturity Method
ASTM C1077	(2017) Standard Practice for Agencies Testing Concrete and Concrete Aggregates for Use in Construction and Criteria for Testing Agency Evaluation
ASTM C1240	(2020) Standard Specification for Silica Fume Used in Cementitious Mixtures
ASTM C1260	(2014) Standard Test Method for Potential Alkali Reactivity of Aggregates (Mortar-Bar Method)
ASTM C1293	(2008; R 2015) Standard Test Method for

Determination of Length Change of Concrete
Due to Alkali-Silica Reaction

ASTM C1567	(2013) Standard Test Method for Potential Alkali-Silica Reactivity of Combinations of Cementitious Materials and Aggregate (Accelerated Mortar-Bar Method)
ASTM C1602/C1602M	(2018) Standard Specification for Mixing Water Used in Production of Hydraulic Cement Concrete
ASTM C1778	(2016) Standard Guide for Reducing the Risk of Deleterious Alkali-Aggregate Reaction in Concrete
ASTM E329	(2020) Standard Specification for Agencies Engaged in Construction Inspection, Testing, or Special Inspection

CONCRETE REINFORCING STEEL INSTITUTE (CRSI)

CRSI 10MSP	(2018) Manual of Standard Practice
CRSI RB4.1	(2016) Supports for Reinforcement Used in Concrete

NATIONAL INSTITUTE OF STANDARDS AND TECHNOLOGY (NIST)

NIST PS 1	(2009) DOC Voluntary Product Standard PS 1-07, Structural Plywood
-----------	---

1.2 DEFINITIONS

- a. "Cementitious material" as used herein must include all portland cement, pozzolan, fly ash, slag cement, and [silica fume].
- b. "Exposed to public view" means situated so that it can be seen from eye level from a public location after completion of the building. A public location is accessible to persons not responsible for operation or maintenance of the building.
- c. "Chemical admixtures" are materials in the form of powder or fluids that are added to the concrete to give it certain characteristics not obtainable with plain concrete mixes.
- d. "Supplementary cementing materials" (SCM) include coal fly ash, [silica fume,]slag cement, natural or calcined pozzolans, and ultra-fine coal ash when used in such proportions to replace the portland cement that result in improvement to sustainability and durability and reduced cost.
- e. "Design strength" (f'c) is the specified compressive strength of concrete at time(s) specified in this section to meet structural design criteria.
- f. "Mass Concrete" is any concrete system that approaches a maximum

temperature of 158 degrees F within the first 72 hours of placement. In addition, it includes all concrete elements with a section thickness of 3 feet or more regardless of temperature.

- g. "Mixture proportioning" is the process of designing concrete mixture proportions to enable it to meet the strength, service life and constructability requirements of the project while minimizing the initial and life-cycle cost.
- h. "Mixture proportions" are the masses or volumes of individual ingredients used to make a unit measure (cubic meter or cubic yard) of concrete.
- i. "Pozzolan" is a siliceous or siliceous and aluminous material, which in itself possesses little or no cementitious value but will, in finely divided form and in the presence of moisture, chemically react with calcium hydroxide at ordinary temperatures to form compounds possessing cementitious properties.
- j. "Workability (or consistence)" is the ability of a fresh (plastic) concrete mix to fill the form/mould properly with the desired work (vibration) and without reducing the concrete's quality. Workability depends on water content, chemical admixtures, aggregate (shape and size distribution), cementitious content and age (level of hydration).

1.3 SUBMITTALS

Government approval is required for submittals with a "G" classification. Submittals not having a "G" classification are for information only. When used, a code following the "G" classification identifies the office that will review the submittal for the Government. Submit the following in accordance with Section 01 33 00 SUBMITTAL PROCEDURES:

SD-01 Preconstruction Submittals

Quality Control Plan; G

Quality Control Personnel Certifications; G

Laboratory Accreditation; G

SD-02 Shop Drawings

Reinforcing Steel; G

SD-03 Product Data

Reinforcement

SD-05 Design Data

Concrete Mix Design; G

SD-06 Test Reports

Concrete Mix Design; G

Compressive Strength Tests; G

Slump Tests

Water

SD-07 Certificates

Reinforcing Bars

1.4 MODIFICATION OF REFERENCES

Accomplish work in accordance with ACI publications except as modified herein. Consider the advisory or recommended provisions to be mandatory. Interpret reference to the "Building Official," the "Structural Engineer," and the "Architect/Engineer" to mean the Contracting Officer.

1.5 DELIVERY, STORAGE, AND HANDLING

Follow ACI 301, ACI 304R and ASTM A934/A934M requirements and recommendations. Do not deliver concrete until vapor retarder, forms, reinforcement, embedded items, and chamfer strips are in place and ready for concrete placement. Do not store concrete curing compounds or sealers with materials that have a high capacity to adsorb volatile organic compound (VOC) emissions. Do not store concrete curing compounds or sealers in occupied spaces.

1.5.1 Reinforcement

Store reinforcement of different sizes and shapes in separate piles or racks raised above the ground to avoid excessive rusting. Protect from contaminants such as grease, oil, and dirt. Ensure bar sizes can be accurately identified after bundles are broken and tags removed.

1.6 QUALITY ASSURANCE

1.6.1 Design Data

1.6.1.1 Concrete Mix Design

Sixty days minimum prior to concrete placement, submit a mix design for each strength and type of concrete. Submit a complete list of materials including type; brand; source and amount of cement, supplementary cementitious materials, and admixtures; and applicable reference specifications. Submit mill test and all other test for cement, supplementary cementitious materials, aggregates, and admixtures. Provide documentation of maximum nominal aggregate size, gradation analysis, percentage retained and passing sieve, and a graph of percentage retained verses sieve size. Provide mix proportion data using at least three different water-cementitious material ratios for each type of mixture, which produce a range of strength encompassing those required for each type of concrete required. If source material changes, resubmit mix proportion data using revised source material. Provide only materials that have been proven by trial mix studies to meet the requirements of this specification, unless otherwise approved in writing by the Contracting Officer. Indicate clearly in the submittal where each mix design is used when more than one mix design is submitted. Resubmit data on concrete components if the qualities or source of components changes. For previously approved concrete mix designs used within the past twelve months, the previous mix design may be re-submitted without further trial batch testing if accompanied by material test data conducted within the

last six months. Obtain mix design approval from the contracting officer prior to concrete placement.

1.6.2 Shop Drawings

1.6.2.1 Reinforcing Steel

Indicate bending diagrams, assembly diagrams, splicing and laps of bars, shapes, dimensions, and details of bar reinforcing, accessories, and concrete cover. Do not scale dimensions from structural drawings to determine lengths of reinforcing bars. Reproductions of contract drawings are unacceptable.

1.6.3 Test Reports

1.6.3.1 Fly Ash and Pozzolan

Submit test results in accordance with ASTM C618 for fly ash and pozzolan. Submit test results performed within 6 months of submittal date.

1.6.3.2 Slag Cement

Submit test results in accordance with ASTM C989/C989M for slag cement. Submit test results performed within 6 months of submittal date.

1.6.3.3 Aggregates

Submit test results in accordance with ASTM C33/C33M, or ASTM C330/C330M for lightweight aggregate, and ASTM C1293 or ASTM C1567 as required in the paragraph titled ALKALI-AGGREGATE REACTION.

1.6.4 Quality Control Plan

Develop and submit for approval a concrete quality control program in accordance with the guidelines of ACI 121R and as specified herein. The plan must include approved laboratories. Provide direct oversight for the concrete qualification program inclusive of associated sampling and testing. All quality control reports must be provided to the Contracting Officer, Quality Manager and Concrete Supplier. Maintain a copy of ACI SP-15 and CRSI 10MSP at project site.

1.6.5 Quality Control Personnel Certifications

The Contractor must submit for approval the responsibilities of the various quality control personnel, including the names and qualifications of the individuals in those positions and a quality control organizational chart defining the quality control hierarchy and the responsibility of the various positions. Quality control personnel must be employed by the Contractor.

Submit American Concrete Institute certification for the following:

- a. CQC personnel responsible for inspection of concrete operations.
- b. Lead Foreman or Journeyman of the Concrete Placing, Finishing, and Curing Crews.
- c. Field Testing Technicians: ACI Concrete Field Testing Technician, Grade I.

1.6.5.1 Quality Manager Qualifications

The quality manager must hold a current license as a professional engineer in a U.S. state or territory with experience on at least five similar projects. Evidence of extraordinary proven experience may be considered by the Contracting Officer as sufficient to act as the Quality Manager.

1.6.5.2 Field Testing Technician and Testing Agency

Submit data on qualifications of proposed testing agency and technicians for approval by the Contracting Officer prior to performing testing on concrete.

- a. Work on concrete under this contract must be performed by an ACI Concrete Field Testing Technician Grade 1 qualified in accordance with ACI SP-2 or equivalent. Equivalent certification programs must include requirements for written and performance examinations as stipulated in ACI SP-2.
- b. Testing agencies that perform testing services on reinforcing steel must meet the requirements of ASTM E329.
- c. Testing agencies that perform testing services on concrete materials must meet the requirements of ASTM C1077.

1.6.6 Laboratory Qualifications for Concrete Qualification Testing

The concrete testing laboratory must have the necessary equipment and experience to accomplish required testing. The laboratory must meet the requirements of ASTM C1077 and be Cement and Concrete Reference Laboratory (CCRL) inspected.

1.6.7 Laboratory Accreditation

Laboratory and testing facilities must be provided by and at the expense of the Contractor. The laboratories performing the tests must be accredited in accordance with ASTM C1077, including ASTM C78/C78M and ASTM C1260. The accreditation must be current and must include the required test methods, as specified. Furthermore, the testing must comply with the following requirements:

- a. Aggregate Testing and Mix Proportioning: Aggregate testing and mixture proportioning studies must be performed by an accredited laboratory and under the direction of a registered professional engineer in a U.S. state or territory competent in concrete materials who is competent in concrete materials and must sign all reports and designs.
- b. Acceptance Testing: Furnish all materials, labor, and facilities required for molding, curing, testing, and protecting test specimens at the site and in the laboratory. Furnish and maintain boxes or other facilities suitable for storing and curing the specimens at the site while in the mold within the temperature range stipulated by ASTM C31/C31M.
- c. Contractor Quality Control: All sampling and testing must be performed by an approved, onsite, independent, accredited laboratory.

1.7 ENVIRONMENTAL REQUIREMENTS

Provide space ventilation according to material manufacturer recommendations, at a minimum, during and following installation of concrete curing compound and sealer. Maintain one of the following ventilation conditions during the curing period or for 72 hours after installation:

- a. Supply 100 percent outside air 24 hours a day.
- b. Supply airflow at a rate of 6 air changes per hour, when outside temperatures are between 55 degrees F and 84 degrees F and humidity is between 30 percent and 60 percent.
- c. Supply airflow at a rate of 1.5 air changes per hour, when outside air conditions are not within the range stipulated above.

1.7.1 Submittals for Environmental Performance

- a. Provide data indication the percentage of post-industrial pozzolan (fly ash, slag cement) cement substitution as a percentage of the full product composite by weight.
- b. Provide data indicating the percentage of post-industrial and post-consumer recycled content aggregate.
- c. Provide product data indicating the percentage of post-consumer recycled steel content in each type of steel reinforcement as a percentage of the full product composite by weight.
- d. Provide product data stating the location where all products were manufactured
- e. For projects using FSC certified formwork, provide chain-of-custody documentation for all certified wood products.
- f. For projects using reusable formwork, provide data showing how formwork is reused.
- g. Provide SDS product information data showing that form release agents meet any environmental performance goals such as using vegetable and soy based products.
- h. Provide SDS product information data showing that concrete adhesives meet any environmental performance goals including low emitting, low volatile organic compound products.

1.8 QUALIFICATIONS FOR WELDING WORK

Welding procedures must be in accordance with AWS D1.4/D1.4M.

Verify that Welder qualifications are in accordance with AWS D1.4/D1.4M for welding of reinforcement or under an equivalent qualification test approved in advance. Welders are permitted to do only the type of welding for which each is specifically qualified.

PART 2 PRODUCTS

2.1 FORMWORK MATERIALS

- a. Form-facing material in contact with concrete must be lumber, plywood, tempered concrete-form-grade hardboard, or treated paper that creates specified appearance and texture of concrete surface. Submit product information on proposed form-facing materials if different from that specified herein.
- b. Design formwork, shores, reshores, and backshores to support loads transmitted to them and to comply with applicable building code requirements.
- c. Design formwork and shoring for load redistribution resulting from stressing of post-tensioned reinforcement. Ensure that formwork allows movement resulting from application of prestressing force.
- d. Design formwork to withstand pressure resulting from placement and vibration of concrete and to maintain specified tolerances.
- e. Design formwork to accommodate waterstop materials in joints at locations indicated in Contract Documents.
- f. Provide temporary openings in formwork if needed to facilitate cleaning and inspection.
- g. Design formwork joints to inhibit leakage of mortar.
- h. Limit deflection of facing materials for concrete surfaces exposed to view to 1/240 of center-to-center spacing of facing supports.
- i. Submit product information on proposed form-facing materials if different from that specified herein.
- j. Submit procedure for reshoring and backshoring, including drawings signed and sealed by a licensed design engineer. Include on shop drawings the formwork removal procedure and magnitude of construction loads used for design of reshoring or backshoring system. Indicate in procedure the magnitude of live and dead loads assumed for required capacity of the structure at time of reshoring or backshoring.
- k. Submit manufacturer's product data on form liner proposed for use with each formed surface.

2.1.1 Wood Forms

Use lumber as follows. Provide lumber that is square edged or tongue-and-groove boards, free of raised grain, knotholes, or other surface defects. Provide plywood that complies with NIST PS 1, B-B concrete form panels or better or AHA A135.4, hardboard for smooth form lining.

2.1.1.1 Concrete Form Plywood (Standard Rough)

Provide plywood that conforms to NIST PS 1, B-B, concrete form, not less than 5/8-inch thick.

2.1.1.2 Overlaid Concrete Form Plywood (Standard Smooth)

Provide plywood that conforms to NIST PS 1, B-B, high density form overlay, not less than 5/8-inch thick.

2.1.2 Carton Forms

Moisture resistant treated paper faces, biodegradable, structurally sufficient to support weight of wet concrete until initial set. Provide carton forms that contain a minimum of 5 percent post-consumer recycled content, or a minimum of 20 percent post-industrial recycled content.

2.2 FORMWORK ACCESSORIES

- a. Use commercially manufactured formwork accessories, including ties and hangers.
- b. Form ties and accessories must not reduce the effective cover of the reinforcement.

2.2.1 Form Ties

- a. Use form ties with ends or end fasteners that can be removed without damage to concrete.
- b. Where indicated in Contract Documents, use form ties with integral water barrier plates or other acceptable positive water barriers in walls.
- c. The breakback distance for ferrous ties must be at least 2 in. for Surface Finish-2.0 or Surface Finish-3.0, as defined in ACI 301.
- d. Submit manufacturer's data sheet on form ties.

2.2.2 Chamfer Materials

Use lumber materials with dimensions of 3/4 x 3/4 in.

2.2.3 Construction and movement joints

- a. Submit details and locations of construction joints in accordance with the requirements herein.
- b. Locate construction joints within middle one-third of spans of slabs, beams, and girders. If a beam intersects a girder within the middle one-third of girder span, the distance between the construction joint in the girder and the edge of the beam must be at least twice the width of the larger member.
- c. For members with post-tensioning tendons, locate construction joints where tendons pass through centroid of concrete section.
- d. Locate construction joints in walls and columns at underside of slabs, beams, or girders and at tops of footings or slabs.
- e. Make construction joints perpendicular to main reinforcement.
- f. Provide movement joints where indicated in Contract Documents or in accepted alternate locations.

- g. Submit location and detail of movement joints if different from those indicated in Contract Documents.
- h. Submit manufacturer's data sheet on expansion joint materials.
- i. Provide keyways where indicated in Contract Documents. Longitudinal keyways indicated in Contract Documents must be at least 1-1/2 in. deep, measured perpendicular to the plane of the joint.

2.2.4 Other Embedded items

Use sleeves, inserts, anchors, and other embedded items of material and design indicated in Contract Documents.

2.3 CONCRETE MATERIALS

2.3.1 Cementitious Materials

2.3.1.1 Portland Cement

- a. Unless otherwise specified, provide cement that conforms to ASTM C150/C150M Type I or II.
- b. Use one brand and type of cement for formed concrete having exposed-to-view finished surfaces.

Submit information along with evidence demonstrating compliance with referenced standards. Submittals must include types of cementitious materials, manufacturing locations, shipping locations, and certificates showing compliance.

- d. Cementitious materials must be stored and kept dry and free from contaminants.

2.3.1.2 Slag Cement

ASTM C989/C989M, Grade 100.

2.3.1.3 Silica Fume

Silica fume must conform to ASTM C1240, including the optional limits on reactivity with cement alkalis. Silica fume may be furnished as a dry, densified material or as slurry. Proper mixing is essential to accomplish proper distribution of the silica fume and avoid agglomerated silica fume which can react with the alkali in the cement resulting in premature and extensive concrete damage. Supervision at the batch plant, finishing, and curing is essential. Provide at the Contractor's expense the services of a manufacturer's technical representative, experienced in mixing, proportioning, placement procedures, and curing of concrete containing silica fume. This representative must be present on the project prior to and during at least the first 4 days of concrete production and placement using silica fume. A High Range Water Reducing admixture (HRWRA) must be used with silica fume.

2.3.1.4 Other Supplementary Cementitious Materials

Natural pozzolan must be raw or calcined and conform to ASTM C618, Class N, including the optional requirements for uniformity and effectiveness in

controlling ASR and must have an ignition loss not exceeding 3 percent. Class N pozzolan for use in mitigating ASR must have a Calcium Oxide (CaO) content of less than 13 percent and total equivalent alkali content less than 3 percent.

Ultra Fine Fly Ash (UFFA) and Ultra Fine Pozzolan (UFP) must conform to ASTM C618, Class F or N, and the following additional requirements:

- a. The strength activity index at 28 days of age must be at least 95 percent of the control specimens.
- b. The average particle size must not exceed 6 microns.
- c. The sum of SiO₂ + Al₂O₃ + Fe₂O₃ must be greater than 77 percent.

2.3.2 Water

- a. Water or ice must comply with the requirements of ASTM C1602/C1602M.
- b. Minimize the amount of water in the mix. Improve workability by adjusting the grading of the aggregate and using admixture rather than by adding water.
- c. Water must be potable; free from injurious amounts of oils, acids, alkalis, salts, organic materials, or other substances deleterious to concrete.
- d. Protect mixing water and ice from contamination during storage and delivery.
- e. Submit test report showing water complies with ASTM C1602/C1602M.

2.3.3 Aggregate

2.3.3.1 Normal-Weight Aggregate

- a. Aggregates must conform to ASTM C33/C33M.
- b. Aggregates used in concrete must be obtained from the same sources and have the same size range as aggregates used in concrete represented by submitted field test records or used in trial mixtures.

Store and handle aggregate in a manner that will avoid segregation and prevents contamination by other materials or other sizes of aggregates. Store aggregates in locations that will permit them to drain freely. Do not use aggregates that contain frozen lumps.

- d. Submit types, pit or quarry locations, producers' names, aggregate supplier statement of compliance with ASTM C33/C33M, and ASTM C1293 expansion data not more than 18 months old.

2.3.4 Admixtures

- a. Chemical admixtures must conform to ASTM C494/C494M.
- b. Air-entraining admixtures must conform to ASTM C260/C260M.
- c. Chemical admixtures for use in producing flowing concrete must conform to ASTM C1017/C1017M.

- d. Do not use calcium chloride admixtures.
- e. Admixtures used in concrete must be the same as those used in the concrete represented by submitted field test records or used in trial mixtures.
- f. Protect stored admixtures against contamination, evaporation, or damage.
- g. To ensure uniform distribution of constituents, provide agitating equipment for admixtures used in the form of suspensions or unstable solutions. Protect liquid admixtures from freezing and from temperature changes that would adversely affect their characteristics.
- h. Submit types, brand names, producers' names, manufacturer's technical data sheets, and certificates showing compliance with standards required herein.

2.4 MISCELLANEOUS MATERIALS

2.4.1 Concrete Curing Materials

Provide concrete curing material in accordance with ACI 301 Section 5 and ACI 308.1 Section 2. Submit product data for concrete curing compounds. Submit manufacturer's instructions for placement of curing compound.

2.5 CONCRETE MIX DESIGN

2.5.1 Properties and Requirements

- a. Use materials and material combinations listed in this section and the contract documents.
- b. Cementitious material content must be adequate for concrete to satisfy the specified requirements for strength, w/cm, durability, and finishability described in this section and the contract documents.
- c. Selected target slump must meet the requirements of this section, the contract documents, and must be within a range of 2 in. minimum to 5 in. maximum. Concrete must not show visible signs of segregation.
- d. The target slump must be enforced for the duration of the project. Determine the slump by ASTM C143/C143M. Slump tolerances must meet the requirements of ACI 117.
- e. The nominal maximum size of coarse aggregate for a mixture must not exceed three-fourths of the minimum clear spacing between reinforcement, one-fifth of the narrowest dimension between sides of forms, or one-third of the thickness of slabs or toppings.
- f. Concrete must be air entrained for members assigned to Exposure Class F1, F2, or F3. The total air content must be in accordance with the requirements of the paragraph titled DURABILITY.
- g. Measure air content at the point of delivery in accordance with ASTM C173/C173M or ASTM C231/C231M.
- h. Concrete for slabs to receive a hard-troweled finish must not contain

an air-entraining admixture or have a total air content greater than 3 percent.

- i. Concrete properties and requirements for each portion of the structure are specified in the table below. Refer to the paragraph titled DURABILITY for more details on exposure categories and their requirements.

	Minimum <i>f'c</i> psi	Exposure Categories^	Miscellaneous Requirements
Slabs-on-ground	4000 at 28 days		
Foundations	4000 at 28 days		

2.5.2 Durability

2.5.2.1 Alkali-Aggregate Reaction

Do not use any aggregate susceptible to alkali-carbonate reaction (ACR). Use one of the three options below for qualifying concrete mixtures to reduce the potential of alkali-silica reaction (ASR):

- a. For each aggregate used in concrete, the expansion result determined in accordance with ASTM C1293 must not exceed 0.04 percent at one year.
- b. For each aggregate used in concrete, the expansion result of the aggregate and cementitious materials combination determined in accordance with ASTM C1567 must not exceed 0.10 percent at an age of 16 days.
- c. Alkali content in concrete (LBA) must not exceed 4 pounds per cubic yard for moderately reactive aggregate or 3 pounds per cubic yard for highly reactive aggregate. Reactivity must be determined by testing in accordance with ASTM C1293 and categorized in accordance with ASTM C1778. Alkali content is calculated as follows:

$$LBA = (\text{cement content, pounds per cubic yard}) \times (\text{equivalent alkali content of portland cement in percent}/100 \text{ percent})$$

2.5.2.2 Concrete Temperature

The temperature of concrete as delivered must not exceed 95°F.

2.5.3 Trial Mixtures

Trial mixtures must be in accordance to ACI 301.

2.5.4 Ready-Mix Concrete

Provide concrete that meets the requirements of ASTM C94/C94M.

Ready-mixed concrete manufacturer must provide duplicate delivery tickets with each load of concrete delivered. Provide delivery tickets with the following information in addition to that required by ASTM C94/C94M:

- a. Type and brand cement
- b. Cement and supplementary cementitious materials content in 94-pound bags per cubic yard of concrete
- c. Maximum size of aggregate
- d. Amount and brand name of admixtures
- e. Total water content expressed by water cementitious material ratio

2.6 REINFORCEMENT

- a. Bend reinforcement cold. Fabricate reinforcement in accordance with fabricating tolerances of ACI 117.
- b. When handling and storing coated reinforcement, use equipment and methods that do not damage the coating. If stored outdoors for more than 2 months, cover coated reinforcement with opaque protective material.
- c. Submit manufacturer's certified test report for reinforcement.
- d. Submit placing drawings showing fabrication dimensions and placement locations of reinforcement and reinforcement supports. Placing drawings must indicate locations of splices, lengths of lap splices, and details of mechanical and welded splices.
- e. Submit request with locations and details of splices not indicated in Contract Documents.
- f. Submit request to place column dowels without using templates.
- g. Submit request and procedure to field-bend or straighten reinforcing bars partially embedded in concrete at locations not indicated in Contract Documents. Field bending or straightening of reinforcing bars is permitted where indicated in the Contract Documents.
- h. Submit request for field cutting, including location and type of bar to be cut and reason field cutting is required.

2.6.1 Reinforcing Bars

- a. Reinforcing bars must be deformed, except spirals, load-transfer dowels, and welded wire reinforcement, which may be plain.
- b. ASTM A615/A615M with the bars marked S, Grade 60

Submit mill certificates for reinforcing bars.

2.6.1.1 Bar Mats

- a. Bar mats must conform to ASTM A184/A184M.
- b. If coated bar mats are required, repair damaged coating as required in the paragraph titled GALVANIZED REINFORCING BARS EPOXY-COATED REINFORCING BARS and DUAL-COATED REINFORCING BARS.

2.6.1.2 Headed Shear Stud Reinforcement

Headed studs and headed stud assemblies must conform to ASTM A1044/A1044M.

2.6.2 Mechanical Reinforcing Bar Connectors

- a. Provide 125 percent minimum yield strength of the reinforcement bar.
- b. Mechanical splices for galvanized reinforcing bars must be galvanized or coated with dielectric material.
- c. Mechanical splices used with epoxy-coated or dual-coated reinforcing bars must be coated with dielectric material.
- d. Submit data on mechanical splices demonstrating compliance with this paragraph.

2.6.3 Welded wire reinforcement

- a. Use welded wire reinforcement specified in Contract Documents and conforming to one or more of the specifications given herein.
- b. Plain welded wire reinforcement must conform to ASTM A1064/A1064M, with welded intersections spaced no greater than 12 in. apart in direction of principal reinforcement.
- c. Deformed welded wire reinforcement must conform to ASTM A1064/A1064M, with welded intersections spaced no greater than 16 in. apart in direction of principal reinforcement.

2.6.4 Reinforcing Bar Supports

- a. Provide reinforcement support types within structure as required by Contract Documents. Reinforcement supports must conform to CRSI RB4.1. Submit description of reinforcement supports and materials for fastening coated reinforcement if not in conformance with CRSI RB4.1.

Legs of supports in contact with formwork must be hot-dip galvanized, or plastic coated after fabrication, or stainless-steel bar supports.

PART 3 EXECUTION

3.1 EXAMINATION

- a. Do not begin installation until substrates have been properly constructed; verify that substrates are level.
- b. If substrate preparation is the responsibility of another installer, notify Contracting Officer of unsatisfactory preparation before processing.

- c. Check field dimensions before beginning installation. If dimensions vary too much from design dimensions for proper installation, notify Contracting Officer and wait for instructions before beginning installation.

3.2 PREPARATION

Determine quantity of concrete needed and minimize the production of excess concrete. Designate locations or uses for potential excess concrete before the concrete is poured.

3.2.1 General

- a. Surfaces against which concrete is to be placed must be free of debris, loose material, standing water, snow, ice, and other deleterious substances before start of concrete placing.
- b. Remove standing water without washing over freshly deposited concrete. Divert flow of water through side drains provided for such purpose.

3.2.2 Subgrade Under Foundations and Footings

- a. When subgrade material is semi-porous and dry, sprinkle subgrade surface with water as required to eliminate suction at the time concrete is deposited, or seal subgrade surface by covering surface with specified vapor retarder.
- b. When subgrade material is porous, seal subgrade surface by covering surface with specified vapor retarder.

3.2.3 Subgrade Under Slabs on Ground

- a. Before construction of slabs on ground, have underground work on pipes and conduits completed and approved.
- b. Previously constructed subgrade or fill must be cleaned of foreign materials
- c. Finish surface of capillary water barrier under interior slabs on ground must not show deviation in excess of 1/4 inch when tested with a 10-foot straightedge parallel with and at right angles to building lines.
- d. Finished surface of subgrade or fill under exterior slabs on ground must not be more than 0.02-foot above or 0.10-foot below elevation indicated.

3.2.4 Edge Forms and Screed Strips for Slabs

- a. Set edge forms or bulkheads and intermediate screed strips for slabs to obtain indicated elevations and contours in finished slab surface and must be strong enough to support vibrating bridge screeds or roller pipe screeds if nature of specified slab finish requires use of such equipment.
- b. Align concrete surface to elevation of screed strips by use of strike-off templates or approved compacting-type screeds.

3.2.5 Reinforcement and Other Embedded Items

- a. Secure reinforcement, joint materials, and other embedded materials in position, inspected, and approved before start of concrete placing.
- b. When concrete is placed, reinforcement must be free of materials deleterious to bond. Reinforcement with rust, mill scale, or a combination of both will be considered satisfactory, provided minimum nominal dimensions, nominal weight, and minimum average height of deformations of a hand-wire-brushed test specimen are not less than applicable ASTM specification requirements.

3.3 FORMS

- a. Provide forms, shoring, and scaffolding for concrete placement. Set forms mortar-tight and true to line and grade.
- b. Chamfer above grade exposed joints, edges, and external corners of concrete 0.75 inch. Place chamfer strips in corners of formwork to produce beveled edges on permanently exposed surfaces.
- c. Provide formwork with clean-out openings to permit inspection and removal of debris.
- d. Inspect formwork and remove foreign material before concrete is placed.
- e. At construction joints, lap form-facing materials over the concrete of previous placement. Ensure formwork is placed against hardened concrete so offsets at construction joints conform to specified tolerances.
- f. Provide positive means of adjustment (such as wedges or jacks) of shores and struts. Do not make adjustments in formwork after concrete has reached initial setting. Brace formwork to resist lateral deflection and lateral instability.
- g. Fasten form wedges in place after final adjustment of forms and before concrete placement.
- h. Provide anchoring and bracing to control upward and lateral movement of formwork system.
- i. Construct formwork for openings to facilitate removal and to produce opening dimensions as specified and within tolerances.
- j. Provide runways for moving equipment. Support runways directly on formwork or structural members. Do not support runways on reinforcement. Loading applied by runways must not exceed capacity of formwork or structural members.
- k. Position and support expansion joint materials, waterstops, and other embedded items to prevent displacement. Fill voids in sleeves, inserts, and anchor slots temporarily with removable material to prevent concrete entry into voids.
- l. Clean surfaces of formwork and embedded materials of mortar, grout, and foreign materials before concrete placement.

3.3.1 Coating

- a. Cover formwork surfaces with an acceptable material that inhibits bond with concrete.
- b. If formwork release agent is used, apply to formwork surfaces in accordance with manufacturer's recommendations before placing reinforcement. Remove excess release agent on formwork prior to concrete placement.
- c. Do not allow formwork release agent to contact reinforcement or hardened concrete against which fresh concrete is to be placed.

3.3.2 Reshoring

- a. Do not allow structural members to be loaded with combined dead and construction loads in excess of loads indicated in the accepted procedure.
- b. Install and remove reshores or backshores in accordance with accepted procedure.
- c. For floors supporting shores under newly placed concrete, either leave original supporting shores in place, or install reshores or backshores. Shoring system and supporting slabs must resist anticipated loads. Locate reshores and backshores directly under a shore position or as indicated on formwork shop drawings.
- d. In multistory buildings, place reshoring or backshoring over a sufficient number of stories to distribute weight of newly placed concrete, forms, and construction live loads.

3.3.3 Reuse

- a. Reuse forms providing the structural integrity of concrete and the aesthetics of exposed concrete are not compromised.
- b. Wood forms must not be clogged with paste and must be capable of absorbing high water-cementitious material ratio paste.
- c. Remove leaked mortar from formwork joints before reuse.

3.3.4 Forms for Standard Rough Form Finish

Provide formwork in accordance with ACI 301 Section 5 with a surface finish, SF-1.0, for formed surfaces that are to be concealed by other construction.

3.3.5 Forms for Standard Smooth Form Finish

Provide formwork in accordance with ACI 301 Section 5 with a surface finish, SF-3.0, for formed surfaces that are exposed to view.

3.3.6 Form Ties

- a. For post-tensioned structures, do not remove formwork supports until stressing records have been accepted by the Contracting Officer.
- b. After ends or end fasteners of form ties have been removed, repair tie

holes in accordance with ACI 301 Section 5 requirements.

3.3.7 Tolerances for Form Construction

- a. Construct formwork so concrete surfaces conform to tolerances in ACI 117.
- b. Position and secure sleeves, inserts, anchors, and other embedded items such that embedded items are positioned within ACI 117 tolerances.
- c. To maintain specified elevation and thickness within tolerances, install formwork to compensate for deflection and anticipated settlement in formwork during concrete placement. Set formwork and intermediate screed strips for slabs to produce designated elevation, camber, and contour of finished surface before formwork removal. If specified finish requires use of vibrating screeds or roller pipe screeds, ensure that edge forms and screed strips are strong enough to support such equipment.

3.3.8 Removal of Forms and Supports

- a. If vertical formed surfaces require finishing, remove forms as soon as removal operations will not damage concrete.
- b. Remove top forms on sloping surfaces of concrete as soon as removal will not allow concrete to sag. Perform repairs and finishing operations required. If forms are removed before end of specified curing period, provide curing and protection.
- c. Do not damage concrete during removal of vertical formwork for columns, walls, and sides of beams. Perform needed repair and finishing operations required on vertical surfaces. If forms are removed before end of specified curing period, provide curing and protection.
- d. Form-facing material and horizontal facing support members may be removed before in-place concrete reaches specified compressive strength if shores and other supports are designed to allow facing removal without deflection of supported slab or member.

3.3.9 Strength of Concrete Required for Removal of Formwork

If removal of formwork, reshoring, or backshoring is based on concrete reaching a specified in-place strength, mold and field-cure cylinders in accordance with ASTM C31/C31M. Test cylinders in accordance with ASTM C39/C39M. Alternatively, use one or more of the methods listed herein to evaluate in-place concrete strength for formwork removal.

- a. Tests of cast-in-place cylinders in accordance with ASTM C873/C873M. This option is limited to slabs with concrete depths from 5 to 12 in.
- b. Penetration resistance in accordance with ASTM C803/C803M.
- c. Pullout strength in accordance with ASTM C900.
- d. Maturity method in accordance with ASTM C1074. Submit maturity method data using project materials and concrete mix proportions used on the project to demonstrate the correlation between maturity and

compressive strength of laboratory cured test specimens to the Contracting Officer.

3.4 PLACING REINFORCEMENT AND MISCELLANEOUS MATERIALS

- a. Unless otherwise specified, placing reinforcement and miscellaneous materials must be in accordance to ACI 301. Provide bars, welded wire reinforcement, wire ties, supports, and other devices necessary to install and secure reinforcement.
- b. Reinforcement must not have rust, scale, oil, grease, clay, or foreign substances that would reduce the bond. Rusting of reinforcement is a basis of rejection if the effective cross-sectional area or the nominal weight per unit length has been reduced. Remove loose rust prior to placing steel. Tack welding is prohibited.
- c. Nonprestressed cast-in-place concrete members must have concrete cover for reinforcement given in the following table:

Concrete Exposure	Member	Reinforcement	Specified cover, in.
Cast against and permanently in contact with ground	All	All	3
Formed and exposed to weather or in contact with ground	All	No. 6 through No. 18 bars	2
		No. 5 bar, W31 or D31 wire, and smaller	1-1/2
Formed and not exposed to weather or in contact with ground	Slabs, joists, and walls	No. 14 and No. 18 bars	1-1/2
		No. 11 bar and smaller	3/4
	Beams, columns, pedestals, and tension ties	Primary reinforcement, stirrups, ties, spirals, and hoops	1-1/2

- d. Cast-in-place prestressed concrete members must have concrete cover for reinforcement, ducts, and end fittings given in the following table:

Concrete	Member	Reinforcement	Specified
Cast against and permanently in contact with ground	All	All	3
Exposed to weather or in contact with ground	Slabs, joists, and walls	All	1
	All other	All	1-1/2
Not exposed to weather or in contact with ground	Slabs, joists, and walls	All	3/4
	Beams, columns, and tension ties	Primary reinforcement	1-1/2
		Stirrups, ties, spirals, and hoops	1

- e. Precast nonprestressed or prestressed concrete members manufactured under plant conditions must have concrete cover for reinforcement, ducts, and end fittings given in the following table:

Concrete Exposure	Member	Reinforcement	Specified cover, in.
Exposed to weather or in contact with ground	Walls	No. 14 and No. 18 bars; tendons larger than 1-1/2 in. diameter	1-1/2
		No. 11 bars and smaller; W31 and D31 wire, and smaller; tendons and strands 1-1/2 in.	3/4
	All other	No. 14 and No. 18 bars; tendons larger than 1-1/2 in.	2
		No. 6 through No. 11 bars; tendons and strands larger than 5/8 in. diameter through 1-1/2 in.	1-1/2
		No. 5 bar, W31 or D31 wire, and smaller; tendons and strands 5/8 in. diameter and smaller	1-1/4

Concrete Exposure	Member	Reinforcement	Specified cover, in.
Not exposed to weather or in contact with ground	Slabs, joists, and walls	No. 14 and No. 18 bars; tendons larger than 1-1/2 in. diameter	1-1/4
		Tendons and strands 1-1/2 in. diameter and smaller	3/4
		No. 11 bar, W31 or D31	5/8
	Beams, columns, pedestals, and tension ties	Primary reinforcement	Greater of bar diameter and 5/8 and need not exceed 1-1/2
		Stirrups, ties, spirals, and hoops	3/8

3.4.1 General

Provide details of reinforcement that are in accordance with the Contract Documents.

3.4.2 Reinforcement Supports

Provide reinforcement support in accordance with CRSI RB4.1 and ACI 301 Section 3 requirements. Supports for coated or galvanized bars must also be coated with electrically compatible material for a distance of at least

2 inches beyond the point of contact with the bars.

3.4.3 Splicing

As indicated in the Contract Documents. For splices not indicated follow ACI 301. Do not splice at points of maximum stress. Overlap welded wire reinforcement the spacing of the cross wires, plus 2 inches.

3.4.4 Future Bonding

Plug exposed, threaded, mechanical reinforcement bar connectors with a greased bolt. Provide bolt threads that match the connector. Countersink the connector in the concrete. Caulk the depression after the bolt is installed.

3.4.5 Setting Miscellaneous Material

Place and secure anchors and bolts, pipe sleeves, conduits, and other such items in position before concrete placement and support against displacement. Plumb anchor bolts and check location and elevation. Temporarily fill voids in sleeves with readily removable material to prevent the entry of concrete.

3.4.6 Fabrication

Shop fabricate reinforcing bars to conform to shapes and dimensions indicated for reinforcement, and as follows:

- a. Provide fabrication tolerances that are in accordance with ACI 117.
- b. Provide hooks and bends that are in accordance with the Contract Documents.

Reinforcement must be bent cold to shapes as indicated. Bending must be done in the shop. Rebending of a reinforcing bar that has been bent incorrectly is not be permitted. Bending must be in accordance with standard approved practice and by approved machine methods.

Deliver reinforcing bars bundled, tagged, and marked. Tags must be metal with bar size, length, mark, and other information pressed in by machine. Marks must correspond with those used on the placing drawings.

Do not use reinforcement that has any of the following defects:

- a. Bar lengths, depths, and bends beyond specified fabrication tolerances
- b. Bends or kinks not indicated on drawings or approved shop drawings
- c. Bars with reduced cross-section due to rusting or other cause

Replace defective reinforcement with new reinforcement having required shape, form, and cross-section area.

3.4.7 Placing Reinforcement

Place reinforcement in accordance with ACI 301.

For slabs on grade (over earth or over capillary water barrier) and for footing reinforcement, support bars or welded wire reinforcement on

precast concrete blocks, spaced at intervals required by size of reinforcement, to keep reinforcement the minimum height specified above the underside of slab or footing.

For slabs other than on grade, supports for which any portion is less than 1 inch from concrete surfaces that are exposed to view or to be painted must be of precast concrete units, plastic-coated steel, or stainless steel protected bar supports. Precast concrete units must be wedge shaped, not larger than 3-1/2 by 3-1/2 inches, and of thickness equal to that indicated for concrete protection of reinforcement. Provide precast units that have cast-in galvanized tie wire hooked for anchorage and blend with concrete surfaces after finishing is completed.

Provide reinforcement that is supported and secured together to prevent displacement by construction loads or by placing of wet concrete, and as follows:

- a. Provide supports for reinforcing bars that are sufficient in number and have sufficient strength to carry the reinforcement they support, and in accordance with ACI 301 and CRSI 10MSP. Do not use supports to support runways for concrete conveying equipment and similar construction loads.
- b. Equip supports on ground and similar surfaces with sand-plates.
- c. Support welded wire reinforcement as required for reinforcing bars.
- d. Secure reinforcements to supports by means of tie wire. Wire must be black, soft iron wire, not less than 16 gage.
- e. Reinforcement must be accurately placed, securely tied at intersections, and held in position during placing of concrete by spacers, chairs, or other approved supports. Point wire-tie ends away from the form. Unless otherwise indicated, numbers, type, and spacing of supports must conform to the Contract Documents.
- f. Bending of reinforcing bars partially embedded in concrete is permitted only as specified in the Contract Documents.

3.4.8 Spacing of Reinforcing Bars

- a. Spacing must be as indicated in the Contract Documents.
- b. Reinforcing bars may be relocated to avoid interference with other reinforcement, or with conduit, pipe, or other embedded items. If any reinforcing bar is moved a distance exceeding one bar diameter or specified placing tolerance, resulting rearrangement of reinforcement is subject to preapproval by the Contracting Officer.

3.4.9 Concrete Protection for Reinforcement

Additional concrete protection must be in accordance with the Contract Documents.

3.4.10 Welding

Welding must be in accordance with AWS D1.4/D1.4M.

3.5 BATCHING, MEASURING, MIXING, AND TRANSPORTING CONCRETE

In accordance with ASTM C94/C94M, ACI 301, ACI 302.1R and ACI 304R, except as modified herein. Batching equipment must be such that the concrete ingredients are consistently measured within the following tolerances: 1 percent for cement and water, 2 percent for aggregate, and 3 percent for admixtures. Furnish mandatory batch ticket information for each load of ready mix concrete.

3.5.1 Measuring

Make measurements at intervals as specified in paragraphs SAMPLING and TESTING.

3.5.2 Mixing

- a. Mix concrete in accordance with ASTM C94/C94M, ACI 301 and ACI 304R.
- b. Machine mix concrete. Begin mixing within 30 minutes after the cement has been added to the aggregates. Place concrete within 90 minutes of either addition of mixing water to cement and aggregates or addition of cement to aggregates if the concrete temperature is less than 84 degrees F.
- c. Reduce mixing time and place concrete within 60 minutes if the concrete temperature is greater than 84 degrees F except as follows: if set retarding admixture is used and slump requirements can be met, limit for placing concrete may remain at 90 minutes. Additional water may be added, provided that both the specified maximum slump and submitted water-cementitious material ratio are not exceeded and the required concrete strength is still met. When additional water is added, an additional 30 revolutions of the mixer at mixing speed is required.
- d. If the entrained air content falls below the specified limit, add a sufficient quantity of admixture, within the manufacturer's recommended dosage, to bring the entrained air content within the specified limits. Dissolve admixtures in the mixing water and mix in the drum to uniformly distribute the admixture throughout the batch. Do not reconstitute concrete that has begun to solidify.
- e. When fibers are used, add fibers together with the aggregates and never as the first component in the mixer. Fibers must be dispensed into the mixing system using appropriate dispensing equipment and procedure as recommended by the manufacturer.

3.5.3 Transporting

Transport concrete from the mixer to the forms as rapidly as practicable. Prevent segregation or loss of ingredients. Clean transporting equipment thoroughly before each batch. Do not use aluminum pipe or chutes. Remove concrete which has segregated in transporting and dispose of as directed.

3.6 PLACING CONCRETE

Place concrete in accordance with ACI 301 Section 5. Concrete shall be placed within 15 minutes of discharge into non-agitating equipment.

3.6.1 Footing Placement

Concrete for footings may be placed in excavations without forms upon inspection and approval by the Contracting Officer. Excavation width must be a minimum of 4 inches greater than indicated.

3.6.2 Pumping

ACI 304R and ACI 304.2R. Pumping must not result in separation or loss of materials nor cause interruptions sufficient to permit loss of plasticity between successive increments. Loss of slump in pumping equipment must not exceed 2 inches at discharge/placement. Do not convey concrete through pipe made of aluminum or aluminum alloy. Avoid rapid changes in pipe sizes. Limit maximum size of coarse aggregate to 33 percent of the diameter of the pipe. Limit maximum size of well-rounded aggregate to 40 percent of the pipe diameter. Take samples for testing at both the point of delivery to the pump and at the discharge end.

3.6.3 Bonding

Surfaces of set concrete at joints, must be roughened and cleaned of laitance, coatings, loose particles, and foreign matter. Roughen surfaces in a manner that exposes the aggregate uniformly and does not leave laitance, loosened particles of aggregate, nor damaged concrete at the surface.

Obtain bonding of fresh concrete that has set as follows:

- a. At joints between footings and walls or columns, between walls or columns and the beams or slabs they support, and elsewhere unless otherwise specified; roughened and cleaned surface of set concrete must be dampened, but not saturated, immediately prior to placing of fresh concrete.
- b. At joints in exposed-to-view work; at vertical joints in walls; at joints near midpoint of span in girders, beams, supported slabs, other structural members; in work designed to contain liquids; the roughened and cleaned surface of set concrete must be dampened but not saturated and covered with a cement grout coating.
- c. Provide cement grout that consists of equal parts of portland cement and fine aggregate by weight with not more than 6 gallons of water per sack of cement. Apply cement grout with a stiff broom or brush to a minimum thickness of 1/16 inch. Deposit fresh concrete before cement grout has attained its initial set.

3.7 WASTE MANAGEMENT

Provide as specified in the Waste Management Plan and as follows.

3.7.1 Mixing Equipment

Before concrete pours, designate Contractor-owned site meeting environmental standards for cleaning out concrete mixing trucks. Minimize water used to wash equipment.

3.7.2 Hardened, Cured Waste Concrete

Crush and reuse hardened, cured waste concrete as fill or as a base course

for pavement.

3.7.3 Reinforcing Steel

Collect reinforcing steel and place in designated area for recycling.

3.8 SURFACE FINISHES EXCEPT FLOOR, SLAB, AND PAVEMENT FINISHES

3.8.1 Defects

Repair surface defects in accordance with ACI 301 Section 5.

3.8.2 Not Against Forms (Top of Walls)

Surfaces not otherwise specified must be finished with wood floats to even surfaces. Finish must match adjacent finishes.

3.8.3 Formed Surfaces

3.8.3.1 Tolerances

Tolerances in accordance with ACI 117 and as indicated.

3.8.3.2 As-Cast Rough Form

Provide for surfaces not exposed to public view a surface finish SF-1.0. Patch holes and defects in accordance with ACI 301.

3.8.3.3 Standard Smooth Finish

Provide for surfaces exposed to public view a surface finish SF-3.0. Patch holes and defects in accordance with ACI 301.

3.9 FLOOR, SLAB, AND PAVEMENT FINISHES AND MISCELLANEOUS CONSTRUCTION

In accordance with ACI 301 and ACI 302.1R, unless otherwise specified. Slope floors uniformly to drains where drains are provided. Steel trowel and fine-broom finish concrete slabs that are to receive quarry tile, ceramic tile, or paver tile. Where straightedge measurements are specified, Contractor must provide straightedge.

3.9.1 Finish

Place, consolidate, and immediately strike off concrete to obtain proper contour, grade, and elevation before bleedwater appears. Permit concrete to attain a set sufficient for floating and supporting the weight of the finisher and equipment. If bleedwater is present prior to floating the surface, drag the excess water off or remove by absorption with porous materials. Do not use dry cement to absorb bleedwater. Grate tampers ("jitterbugs") shall not be used.

3.9.1.1 Scratched

Use for surfaces intended to receive bonded applied cementitious applications. Finish concrete in accordance with ACI 301 Section 5 for a scratched finish.

3.9.1.2 Steel Troweled

Use for floors intended as walking surfaces. Finish concrete in accordance with ACI 301 Section 5 for a steel troweled finish.

3.9.1.3 Broomed

Use on surfaces of exterior walks, platforms, patios, and ramps, unless otherwise indicated. Finish concrete in accordance with ACI 301 Section 5 for a broomed finish.

3.9.1.4 Pavement

Screed the concrete with a template advanced with a combined longitudinal and crosswise motion. Maintain a slight surplus of concrete ahead of the template. After screeding, float the concrete longitudinally. Use a straightedge to check slope and flatness; correct and refloat as necessary. Obtain final finish by belting. Lay belt flat on the concrete surface and advance with a sawing motion; continue until a uniform but gritty nonslip surface is obtained. Round edges and joints with an edger having a radius of 1/8 inch.

3.9.2 Concrete Walks

Provide 4 inches thick minimum. Provide contraction joints spaced every 5 linear feet unless otherwise indicated. Cut contraction joints 1 inch deep, or one fourth the slab thickness whichever is deeper, with a jointing tool after the surface has been finished. Provide 0.5 inch thick transverse expansion joints at changes in direction where sidewalk abuts curb, steps, rigid pavement, or other similar structures; space expansion joints every 50 feet maximum. Give walks a broomed finish. Unless indicated otherwise, provide a transverse slope of 1/48. Limit variation in cross section to 1/4 inch in 5 feet.

3.9.3 Pits and Trenches

Place bottoms and walls monolithically or provide waterstops and keys.

3.9.4 Curbs and Gutters

Provide contraction joints spaced every 10 feet maximum unless otherwise indicated. Cut contraction joints 3/4 inch deep with a jointing tool after the surface has been finished. Provide expansion joints 1/2 inch thick and spaced every 100 feet maximum unless otherwise indicated. Perform pavement finish.

3.10 JOINTS

3.10.1 Construction Joints

Make and locate joints not indicated so as not to impair strength and appearance of the structure, as approved. Joints must be perpendicular to main reinforcement. Reinforcement must be continued and developed across construction joints. Locate construction joints as follows:

3.10.1.1 Maximum Allowable Construction Joint Spacing

- a. In walls at not more than 60 feet in any horizontal direction.

- b. In slabs on ground, so as to divide slab into areas not in excess of 1,200 square feet.

3.10.1.2 Construction Joints for Constructability Purposes

- a. In walls, at top of footing; at top of slabs on ground; at top and bottom of door and window openings or where required to conform to architectural details; and at underside of deepest beam or girder framing into wall.
- b. In columns or piers, at top of footing; at top of slabs on ground; and at underside of deepest beam or girder framing into column or pier.
- c. Near midpoint of spans for supported slabs, beams, and girders unless a beam intersects a girder at the center, in which case construction joints in girder must offset a distance equal to twice the width of the beam. Make transfer of shear through construction joint by use of inclined reinforcement.

Provide keyways at least 1-1/2-inches deep in construction joints in walls and slabs and between walls and footings; approved bulkheads may be used for slabs.

3.10.2 Isolation Joints in Slabs on Ground

- a. Provide joints at points of contact between slabs on ground and vertical surfaces, such as column pedestals, foundation walls, grade beams, and elsewhere as indicated.
- b. Fill joints with premolded joint filler strips 1/2 inch thick, extending full slab depth. Install filler strips at proper level below finish floor elevation with a slightly tapered, dress-and-oiled wood strip temporarily secured to top of filler strip to form a groove not less than 3/4 inch in depth where joint is sealed with sealing compound and not less than 1/4 inch in depth where joint sealing is not required. Remove wood strip after concrete has set. Contractor must clean groove of foreign matter and loose particles after surface has dried.

3.10.3 Contraction Joints in Slabs on Ground

- a. Provide joints to form panels as indicated.
- b. Under and on exact line of each control joint, cut 50 percent of welded wire reinforcement before placing concrete.
- c. Sawcut contraction joints into slab on ground in accordance with ACI 301 Section 5.
- d. Joints must be 1/8-inch wide by 1/5 to 1/4 of slab depth and formed by inserting hand-pressed fiberboard strip into fresh concrete until top surface of strip is flush with slab surface. After concrete has cured for at least 7 days, the Contractor must remove inserts and clean groove of foreign matter and loose particles.
- e. Sawcutting will be limited to within 12 hours after set and at 1/4 slab depth.

3.10.4 Sealing Joints in Slabs on Ground

- a. Contraction and control joints which are to receive finish flooring material must be sealed with joint sealing compound after concrete curing period. Slightly underfill groove with joint sealing compound to prevent extrusion of compound. Remove excess material as soon after sealing as possible.
- b. Sealed groove must be left ready to receive filling material that is provided as part of finish floor covering work.

3.11 CURING AND PROTECTION

Curing and protection in accordance with ACI 301 Section 5, unless otherwise specified. Begin curing immediately following form removal. Avoid damage to concrete from vibration created by blasting, pile driving, movement of equipment in the vicinity, disturbance of formwork or protruding reinforcement, and any other activity resulting in ground vibrations. Protect concrete from injurious action by sun, rain, flowing water, frost, mechanical injury, tire marks, and oil stains. Do not allow concrete to dry out from time of placement until the expiration of the specified curing period. Do not use membrane-forming compound on surfaces where appearance would be objectionable, on any surface to be painted, where coverings are to be bonded to the concrete, or on concrete to which other concrete is to be bonded. If forms are removed prior to the expiration of the curing period, provide another curing procedure specified herein for the remaining portion of the curing period. Provide moist curing for those areas receiving liquid chemical sealer, hardener, or epoxy coating. Allow curing compound/sealer installations to cure prior to the installation of materials that adsorb VOCs.

3.11.1 Curing Periods

ACI 301 Section 5, except 10 days for retaining walls, pavement or chimneys. Begin curing immediately after placement. Protect concrete from premature drying, excessively hot temperatures, and mechanical injury; and maintain minimal moisture loss at a relatively constant temperature for the period necessary for hydration of the cement and hardening of the concrete. The materials and methods of curing are subject to approval by the Contracting Officer.

3.11.2 Curing Formed Surfaces

Accomplish curing of formed surfaces, including undersurfaces of girders, beams, supported slabs, and other similar surfaces by moist curing with forms in place for full curing period or until forms are removed. If forms are removed before end of curing period, accomplish final curing of formed surfaces by any of the curing methods specified above, as applicable.

3.11.3 Curing Unformed Surfaces

- a. Accomplish initial curing of unformed surfaces, such as monolithic slabs, floor topping, and other flat surfaces, by membrane curing.
- b. Accomplish final curing of unformed surfaces by any of curing methods specified, as applicable.
- c. Accomplish final curing of concrete surfaces to receive liquid floor

hardener of finish flooring by moisture-retaining cover curing.

3.11.4 Temperature of Concrete During Curing

When temperature of atmosphere is 41 degrees F and below, maintain temperature of concrete at not less than 55 degrees F throughout concrete curing period or 45 degrees F when the curing period is measured by maturity. When necessary, make arrangements before start of concrete placing for heating, covering, insulation, or housing as required to maintain specified temperature and moisture conditions for concrete during curing period.

When the temperature of atmosphere is 80 degrees F and above or during other climatic conditions which cause too rapid drying of concrete, make arrangements before start of concrete placing for installation of wind breaks, of shading, and for fog spraying, wet sprinkling, or moisture-retaining covering of light color as required to protect concrete during curing period.

Changes in temperature of concrete must be uniform and not exceed 37 degrees F in any 1 hour nor 80 degrees F in any 24-hour period.

3.11.5 Protection from Mechanical Injury

During curing period, protect concrete from damaging mechanical disturbances, particularly load stresses, heavy shock, and excessive vibration and from damage caused by rain or running water.

3.11.6 Protection After Curing

Protect finished concrete surfaces from damage by construction operations.

3.12 FIELD QUALITY CONTROL

3.12.1 Aggregate Testing

3.12.1.1 Fine Aggregate

At least once during each shift when the concrete plant is operating, there shall be one sieve analysis and fineness modulus determination in accordance with ASTM C136/C136M and COE CRD-C 104 for the fine aggregate or for each fine aggregate if it is batched in more than one size or classification. The location at which samples are taken may be selected by the Contractor as the most advantageous for control. However, the Contractor is responsible for delivering fine aggregate to the mixer within specification limits. When the amount passing on any sieve is outside the specification limits, the fine aggregate shall be immediately resampled and retested. If there is another failure on any sieve, the fact shall be immediately reported to the Contracting Officer, concreting shall be stopped, and immediate steps taken to correct the grading.

3.12.1.2 Coarse Aggregate

At least once during each shift in which the concrete plant is operating, there shall be a sieve analysis in accordance with ASTM C136/C136M for each size of coarse aggregate. The location at which samples are taken may be selected by the Contractor as the most advantageous for production control. However, the Contractor shall be responsible for delivering the aggregate to the mixer within specification limits. A test record of

samples of aggregate taken at the same locations shall show the results of the current test as well as the average results of the five most recent tests including the current test. The Contractor may adopt limits for control coarser than the specification limits for samples taken other than as delivered to the mixer to allow for degradation during handling. When the amount passing any sieve is outside the specification limits, the coarse aggregate shall be immediately resampled and retested. If the second sample fails on any sieve, that fact shall be reported to the Contracting Officer. Where two consecutive averages of 5 tests are outside specification limits, the operation shall be considered out of control and reported to the Contracting Officer. Concreting shall be stopped and immediate steps shall be taken to correct the grading.

3.12.2 Concrete Sampling

ASTM C172/C172M. Collect samples of fresh concrete to perform tests specified. ASTM C31/C31M for making test specimens.

3.12.3 Concrete Testing

3.12.3.1 Slump Tests

ASTM C143/C143M. Take concrete samples during concrete placement/discharge. The maximum slump may be increased as specified with the addition of an approved admixture provided that the water-cementitious material ratio is not exceeded. Perform tests at commencement of concrete placement, when test cylinders are made, and for each batch (minimum) or every 20 cubic yards (maximum) of concrete.

3.12.3.2 Temperature Tests

Test the concrete delivered and the concrete in the forms. Perform tests in hot or cold weather conditions (below 50 degrees F and above 80 degrees F) for each batch (minimum) or every 20 cubic yards (maximum) of concrete, until the specified temperature is obtained, and whenever test cylinders and slump tests are made.

3.12.3.3 Compressive Strength Tests

ASTM C39/C39M. Make six 6 inch by 12 inch test cylinders for each set of tests in accordance with ASTM C31/C31M, ASTM C172/C172M and applicable requirements of ACI 305R and ACI 306R. Take precautions to prevent evaporation and loss of water from the specimen. Test two cylinders at 7 days, two cylinders at 28 days, and hold two cylinder in reserve. Take samples for strength tests of each mix design of and for concrete placed each day not less than once a day, nor less than once for each 100 cubic yards of concrete for the first 500 cubic yards, then every 500 cubic yards thereafter, nor less than once for each 5400 square feet of surface area for slabs or walls. For the entire project, take no less than five sets of samples and perform strength tests for each mix design of concrete placed. Each strength test result must be the average of two cylinders from the same concrete sample tested at 28 days. Concrete compressive tests must meet the requirements of this section, the Contract Document, and ACI 301. Retest locations represented by erratic core strengths. Where retest does not meet concrete compressive strength requirements submit a mitigation or remediation plan for review and approval by the contracting officer. Repair core holes with nonshrink grout. Match color and finish of adjacent concrete.

3.12.3.4 Unit Weight of Structural Concrete

ASTM C567/C567M and ASTM C138/C138M. Determine unit weight of normal weight concrete. Perform test for every 20 cubic yards maximum.

3.12.3.5 Strength of Concrete Structure

The strength of the concrete structure will be considered to be deficient if any of the following conditions are identified:

- a. Failure to meet compressive strength tests as evaluated.
- b. Reinforcement not conforming to requirements specified.
- c. Concrete which differs from required dimensions or location in such a manner as to reduce strength.
- d. Concrete curing and protection of concrete against extremes of temperature during curing, not conforming to requirements specified.
- e. Concrete subjected to damaging mechanical disturbances, particularly load stresses, heavy shock, and excessive vibration.
- f. Poor workmanship likely to result in deficient strength.

Where the strength of the concrete structure is considered deficient submit a mitigation or remediation plan for review and approval by the contracting officer.

3.12.3.6 Non-Conforming Materials

Factors that indicate that there are non-conforming materials include (but not limited to) excessive compressive strength, inadequate compressive strength, excessive slump, excessive voids and honeycombing, concrete delivery records that indicate excessive time between mixing and placement, or excessive water was added to the mixture during delivery and placement. Any of these indicators alone are sufficient reason for the Contracting Officer to request additional sampling and testing.

Investigations into non-conforming materials must be conducted at the Contractor's expense. The Contractor must be responsible for the investigation and must make written recommendations to adequately mitigate or remediate the non-conforming material. The Contracting Officer may accept, accept with reduced payment, require mitigation, or require removal and replacement of non-conforming material at no additional cost to the Government.

3.12.3.7 Testing Concrete Structure for Strength

When there is evidence that strength of concrete structure in place does not meet specification requirements or there are non-conforming materials, make cores drilled from hardened concrete for compressive strength determination in accordance with ASTM C42/C42M, and as follows:

- a. Take at least three representative cores from each member or area of concrete-in-place that is considered potentially deficient. Location of cores will be determined by the Contracting Officer.
- b. Test cores after moisture conditioning in accordance with ASTM C42/C42M

if concrete they represent is more than superficially wet under service.

- c. Air dry cores, (60 to 80 degrees F with relative humidity less than 60 percent) for 7 days before test and test dry if concrete they represent is dry under service conditions.
- d. Strength of cores from each member or area are considered satisfactory if their average is equal to or greater than 85 percent of the 28-day design compressive strength of the class of concrete.

Fill core holes solid with patching mortar and finished to match adjacent concrete surfaces.

Correct concrete work that is found inadequate by core tests in a manner approved by the Contracting Officer.

3.13 REPAIR, REHABILITATION AND REMOVAL

Before the Contracting Officer accepts the structure the Contractor must inspect the structure for cracks, damage and substandard concrete placements that may adversely affect the service life of the structure. A report documenting these defects must be prepared which includes recommendations for repair, removal or remediation must be submitted to the Contracting Officer for approval before any corrective work is accomplished.

3.13.1 Crack Repair

Prior to final acceptance, all cracks in excess of 0.02 inches wide must be documented and repaired. The proposed method and materials to repair the cracks must be submitted to the Contracting Officer for approval. The proposal must address the amount of movement expected in the crack due to temperature changes and loading.

3.13.2 Repair of Weak Surfaces

Weak surfaces are defined as mortar-rich, rain-damaged, uncured, or containing exposed voids or deleterious materials. Concrete surfaces with weak surfaces less than 1/4 inch thick must be diamond ground to remove the weak surface. Surfaces containing weak surfaces greater than 1/4 inch thick must be removed and replaced or mitigated in a manner acceptable to the Contracting Officer.

3.13.3 Failure of Quality Assurance Test Results

Proposed mitigation efforts by the Contractor must be approved by the Contracting Officer prior to proceeding.

-- End of Section --

SECTION 04 20 00

UNIT MASONRY

PART 1 GENERAL

1.1 REFERENCES

The publications listed below form a part of this specification to the extent referenced. The publications are referred to within the text by the basic designation only.

AMERICAN CONCRETE INSTITUTE (ACI)

ACI SP-66 (2004) ACI Detailing Manual

ASTM INTERNATIONAL (ASTM)

ASTM A153/A153M (2016a) Standard Specification for Zinc Coating (Hot-Dip) on Iron and Steel Hardware

ASTM A615/A615M (2020) Standard Specification for Deformed and Plain Carbon-Steel Bars for Concrete Reinforcement

ASTM A951/A951M (2011) Standard Specification for Steel Wire for Masonry Joint Reinforcement

ASTM A996/A996M (2016) Standard Specification for Rail-Steel and Axle-Steel Deformed Bars for Concrete Reinforcement

ASTM A1008/A1008M (2020) Standard Specification for Steel, Sheet, Cold-Rolled, Carbon, Structural, High-Strength Low-Alloy, High-Strength Low-Alloy with Improved Formability, Solution Hardened, and Bake Hardenable

ASTM A1064/A1064M (2017) Standard Specification for Carbon-Steel Wire and Welded Wire Reinforcement, Plain and Deformed, for Concrete

ASTM C90 (2016) Standard Specification for Loadbearing Concrete Masonry Units

ASTM C207 (2018) Standard Specification for Hydrated Lime for Masonry Purposes

ASTM C270 (2019) Standard Specification for Mortar for Unit Masonry

ASTM C476 (2020) Standard Specification for Grout for Masonry

ASTM C494/C494M (2019) Standard Specification for Chemical Admixtures for Concrete

ASTM C641 (2017) Standard Test Method for Iron Staining Materials in Lightweight Concrete Aggregates

ASTM C780 (2020) Standard Test Method for Preconstruction and Construction Evaluation of Mortars for Plain and Reinforced Unit Masonry

ASTM C1019 (2019) Standard Test Method for Sampling and Testing Grout

ASTM C1314 (2014) Standard Test Method for Compressive Strength of Masonry Prisms

ASTM C1611/C1611M (2014) Standard Test Method for Slump Flow of Self-Consolidating Concrete

THE MASONRY SOCIETY (TMS)

TMS MSJC (2016) Masonry Standard Joint Committee's (MSJC) Book - Building Code Requirements and Specification for Masonry Structures, Containing TMS 402/ACI 530/ASCE 5, TMS 602/ACI 530.1/ASCE 6, and Companion Commentaries

1.2 SUBMITTALS

Government approval is required for submittals with a "G" classification. Submittals not having a "G" classification are for information only. When used, a code following the "G" classification identifies the office that will review the submittal for the Government. Submit the following in accordance with Section 01 33 00 SUBMITTAL PROCEDURES:

SD-02 Shop Drawings

Cut CMU Drawings; G

Reinforcement Detail Drawings; G

SD-05 Design Data

Masonry Compressive Strength; G

SD-07 Certificates

Concrete Masonry Units (CMU)

Admixtures for Masonry Mortar

Admixtures for Grout

Joint Reinforcement

1.3 DELIVERY, STORAGE, AND HANDLING

Deliver, store, handle, and protect material to avoid chipping, breakage, and contact with soil or contaminating material. Store and prepare materials in already disturbed areas to minimize project site disturbance and size of project site.

1.3.1 Masonry Units

Cover and protect masonry units from precipitation. Conform to handling and storage requirements of TMS MSJC.

- a. Pack glazed brick, glazed structural clay tile, and prefaced concrete masonry units in the manufacturer's standard paper cartons, trays, or shrink wrapped pallets with a divider between each unit. Do not stack pallets. Do not remove units from cartons until cartons are placed on scaffolds or in the location where units are to be laid.
- b. Mark prefabricated lintels on top sides to show either the lintel schedule number or the number and size of top and bottom bars.

1.3.2 Reinforcement, Anchors, and Ties

Store steel reinforcing bars, coated anchors, ties, and joint reinforcement above the ground. Maintain steel reinforcing bars and uncoated ties free of loose mill scale and loose rust.

1.3.3 Cementitious Materials, Sand and Aggregates

Deliver cementitious and other packaged materials in unopened containers, plainly marked and labeled with manufacturers' names and brands. Store cementitious material in dry, weathertight enclosures or completely cover. Handle cementitious materials in a manner that will prevent the inclusion of foreign materials and damage by water or dampness. Store sand and aggregates in a manner to prevent contamination and segregation.

1.4 PROJECT/SITE CONDITIONS

Conform to TMS MSJC for hot and cold weather masonry erection.

1.4.1 Hot Weather Procedures

When ambient air temperature exceeds 100 degrees F, or exceeds 90 degrees F and the wind velocity is greater than 8 mph, comply with TMS MSJC Article 1.8 D for: preparation prior to conducting masonry work; construction while masonry work is in progress; and protection for newly completed masonry.

PART 2 PRODUCTS

2.1 SYSTEM DESCRIPTION

2.1.1 Design - Specified Compressive Strength of Masonry

The specified compressive strength of masonry, f'_m , is 1,500 psi.

2.1.2 Performance - Verify Masonry Compressive Strength

Verify specified compressive strength of masonry using the "Unit Strength

Method" of TMS MSJC. Submit calculations and certifications of unit and mortar strength.

Verify specified compressive strength of masonry using the "Prism Test Method" of TMS MSJC when the "Unit Strength Method" cannot be used. Submit test results.

2.2 MANUFACTURED UNITS

2.2.1 General Requirements

Do not change the source of materials, which will affect the appearance of the finished work, after the work has started except with Contracting Officer's approval. Submit test reports from an approved independent laboratory. Certify test reports on a previously tested material as the same materials as that proposed for use in this project. Submit certificates of compliance stating that the materials meet the specified requirements.

2.2.2 Concrete Units

2.2.2.1 Aggregates

Test lightweight aggregates, and blends of lightweight and heavier aggregates in proportions used in producing the units, for stain-producing iron compounds in accordance with ASTM C641, visual classification method. Do not incorporate aggregates for which the iron stain deposited on the filter paper exceeds the "light stain" classification.

2.2.2.2 Concrete Masonry Units (CMU)

2.2.2.2.1 Size

Provide units with specified dimension of 8 inches wide, 8 inches high, and 16 inches long.

2.2.2.2.2 Surfaces

Provide units with exposed surfaces that are smooth and of uniform texture.

2.2.2.2.3 Weather Exposure

Provide concrete masonry units with water-repellant admixture added during manufacture where units will be exposed to weather.

2.2.2.2.4 Unit Types

- a. Hollow Load-Bearing Units: ASTM C90, normal weight. Provide load-bearing units for exterior walls, foundation walls, load-bearing walls, and shear walls.

2.3 EQUIPMENT

2.3.1 Vibrators

Maintain at least one spare vibrator on site at all times.

2.3.2 Grout Pumps

Pumping through aluminum tubes is not permitted.

2.4 MATERIALS

2.4.1 Mortar Materials

2.4.1.1 Cementitious Materials

Provide cementitious materials that conform to those permitted by ASTM C270.

2.4.1.2 Hydrated Lime and Alternates

Provide lime that conforms to one of the materials permitted by ASTM C207 for use in combination with portland cement, hydraulic cement, and blended hydraulic cement. Do not use lime in combination with masonry cement or mortar cement.

2.4.1.3 Aggregate and Water

Provide aggregate (sand) and water that conform to materials permitted by ASTM C270.

2.4.2 Grout and Ready-Mix Grout Materials

2.4.2.1 Cementitious Materials for Grout

Provide cementitious materials that conform to those permitted by ASTM C476.

2.4.2.2 Admixtures for Grout

Water-reducing admixtures that conform to ASTM C494/C494M Type F or G and viscosity-modifying admixtures that conform to ASTM C494/C494M Type S are permitted for use in grout. Other admixtures require approval by the Contracting Officer.

In cold weather, a non-chloride based accelerating admixture may be used subject to approval by the Contracting Officer; use accelerating admixture that is non-corrosive and conforms to ASTM C494/C494M, Type C.

2.4.2.3 Aggregate and Water

Provide fine and coarse aggregates and water that conform to materials permitted by ASTM C476.

2.5 MORTAR AND GROUT MIXES

2.5.1 Mortar Mix

- a. Provide mortar Type M unless specified otherwise herein.
- b. Use ASTM C270 Type M cement-lime mortar or mortar cement mortar for seismic-force-resisting elements indicated.
- c. Provide mortar that conforms to ASTM C270. Use Type M mortar for foundation walls.

For field-batched mortar, measure component materials by volume. Use

measuring boxes for materials that do not come in packages, such as sand, for consistent batching. Mix cementitious materials and aggregates between 3 and 5 minutes in a mechanical batch mixer with a sufficient amount of water to produce a workable consistency. Do not hand mix mortar unless approved by the Contracting Officer. Maintain workability of mortar by remixing or retempering. Discard mortar that has begun to stiffen or is not used within 2-1/2 hours after initial mixing.

2.5.2 Grout and Ready Mix Grout Mix

Use grout that conforms to ASTM C476, fine. Use conventional grout with a slump between 8 and 11 inches. Use self-consolidating grout with slump flow of 24 to 30 inches and a visual stability index (VSI) not greater than 1. Provide minimum grout strength of 3000 psi in 28 days, as tested in accordance with ASTM C1019. Do not change proportions and do not use materials with different physical or chemical characteristics in grout for the work unless additional evidence is furnished that grout meets the specified requirements. Use ready-mixed grout that conforms to ASTM C476.

2.6 ACCESSORIES

2.6.1 Grout Barriers

Grout barriers for vertical cores that consist of fine mesh wire, fiberglass, or expanded metal.

2.6.2 Anchors, Ties, and Bar Positioners

2.6.2.1 General

- a. Fabricate anchors and ties without drips or crimps. Size anchors and ties to provide a minimum of 5/8 inch mortar cover from each face of masonry.
- b. Fabricate steel wire anchors and ties shall from wire conforming to ASTM A1064/A1064M and hot-dip galvanize in accordance with ASTM A153/A153M.
- c. Fabricate joint reinforcement in conformance with ASTM A951/A951M. Hot dip galvanize joint reinforcement in exterior walls and in interior walls exposed to moist environment in conformance with ASTM A153/A153M.
- d. Fabricate sheet metal anchors and ties in conformance with ASTM A1008/A1008M. Hot dip galvanize sheet metal anchors and ties in exterior walls and in interior walls exposed to moist environment in compliance with ASTM A153/A153M Class B.

2.6.2.2 Bar Positioners

Factory-fabricate bar positioners, used to prevent displacement of reinforcing bars during the course of construction, from 9 gauge steel wire or equivalent, and hot-dip galvanized. Bar positioners must be suitable for intended use and be corrosion resistant steel. Bar positioners not fully contained within the wythe must be hot-dip galvanized.

2.6.3 Joint Reinforcement

Factory fabricate joint reinforcement in conformance with ASTM A951/A951M, welded construction. Provide ladder type joint reinforcement, having one longitudinal wire in the mortar bed of each face shell for hollow units and one wire for solid units and with all wires a minimum of 9 gauge. Size joint reinforcement to provide a minimum of 5/8 inch cover from each face. Space crosswires not more than 16 inches. Provide joint reinforcement for straight runs in flat sections not less than 10 feet long. Provide joint reinforcement with factory formed corners and intersections.

2.6.4 Reinforcing Steel Bars

Reinforcing steel bars and rods shall conform to ASTM A615/A615M or ASTM A996/A996M, Grade 60.

PART 3 EXECUTION

3.1 EXAMINATION

Prior to start of work, verify the applicable conditions as set forth in TMS MSJC, inspection.

3.2 PREPARATION

3.2.1 Stains

Protect exposed surfaces from mortar and other stains. When mortar joints are tooled, remove mortar from exposed surfaces with fiber brushes and wooden paddles. Protect base of walls from splash stains by covering adjacent ground with sand, sawdust, or polyethylene.

3.2.2 Loads

Do not apply uniform loads for at least 12 hours or concentrated loads for at least 72 hours after masonry is constructed. Provide temporary bracing as required.

3.2.3 Concrete Surfaces

Where masonry is to be placed, clean concrete of laitance, dust, dirt, oil, organic matter, or other foreign materials and slightly roughen to provide a surface texture with a depth of at least 1/8 inch. Sandblast, if necessary, to remove laitance from pores and to expose the aggregate.

3.2.4 Shelf Angles

Adjust shelf angles as required to keep the masonry level and at the proper elevation.

3.2.5 Bracing

Provide bracing and scaffolding necessary for masonry work. Design bracing to resist wind pressure as required by OSHA and local codes and submit bracing calculations, sealed by a registered professional engineer. Do not remove bracing in less than 10 days.

3.3 ERECTION

3.3.1 General

- a. Coordinate masonry work with the work of other trades to accommodate built-in items and to avoid cutting and patching. Lay masonry units in running bond pattern. Lay facing courses level with back-up courses, unless the use of adjustable ties has been approved in which case the tolerance is plus or minus 1/2 inch. Adjust each unit to its final position while mortar is still soft and has plastic consistency.
- b. Remove and clean units that have been disturbed after the mortar has stiffened, and relay with fresh mortar. Keep air spaces, cavities, chases, expansion joints, and spaces to be grouted free from mortar and other debris. Select units to be used in exposed masonry surfaces from those having the least amount of chipped edges or other imperfections detracting from the appearance of the finished work.
- c. When necessary to temporarily discontinue the work, step (rack) back the masonry for joining when work resumes. Tothing may be used only when specifically approved by the Contracting Officer. Before resuming work, remove loose mortar and thoroughly clean the exposed joint. Cover the top of walls subjected to rain or snow with nonstaining waterproof covering or membrane when work is not in process. Extend the covering a minimum of 610 mm (2 feet) down on each side of the wall and hold securely in place.
- d. Ensure that units being laid and surfaces to receive units are free of water film and frost. Lay solid units in a nonfurrowed full bed of mortar. Bevel mortar for veneer wythes and slope down toward the cavity side. Shove units into place so that the vertical joints are tight. Completely fill vertical joints between solid units with mortar, except where indicated at control, expansion, and isolation joints. Place hollow units so that mortar extends to the depth of the face shell at heads and beds, unless otherwise indicated. Mortar will be permitted to protrude up to 1/2 inch into the space or cells to be grouted. Provide means to prevent mortar from dropping into the space below or clean grout spaces prior to grouting.

3.3.1.1 Jointing

Tool mortar joints when the mortar is thumbprint hard. Tool horizontal joints after tooling vertical joints. Brush mortar joints to remove loose and excess mortar.

3.3.1.1.1 Tooled Joints

Tool mortar joints in exposed exterior and interior masonry surfaces concave, using a jointer that is slightly larger than the joint width so that complete contact is made along the edges of the unit. Perform tooling so that the mortar is compressed and the joint surface is sealed. Use a jointer of sufficient length to obtain a straight and true mortar joint. No exterior joints are to be left un-tooled.

3.3.1.1.2 Joint Widths

- a. Construct brick masonry with mortar joint widths equal to the difference between the specified and nominal dimensions of the unit,

within tolerances permitted by TMS MSJC.

- b. Provide 3/8 inch wide mortar joints in concrete masonry, except for prefaced concrete masonry units.
- c. Provide 3/8 inch wide mortar joints on unfaced side of prefaced concrete masonry units and not less than 3/16 inch nor more than 1/4 inch wide on prefaced side.
- d. Maintain mortar joint widths within tolerances permitted by TMS MSJC

3.3.1.2 Cutting and Fitting

Use full units of the proper size wherever possible, in lieu of cut units. Locate cut units where they would have the least impact on the architectural aesthetic goals of the facility. Perform cutting and fitting, including that required to accommodate the work of others, by masonry mechanics using power masonry saws. Concrete masonry units may be wet or dry cut. Before being placed in the work, dry wet-cut units to the same surface-dry appearance as uncut units being laid in the wall. Provide cut edges that are clean, true and sharp.

3.3.1.3 Unfinished Work

Rack back unfinished work for joining with new work. Tothing may be resorted to only when specifically approved by the Contracting Officer. Remove loose mortar and thoroughly clean the exposed joints before laying new work.

3.4 INSTALLATION

3.4.1 Bar Reinforcement Installation

3.4.1.1 Preparation

Submit detail drawings showing bar splice locations. Identify bent bars on a bending diagram and reference and locate such bars on the drawings. Show wall dimensions, bar clearances, and wall openings. Utilize bending details that conform to the requirements of ACI SP-66. No approval will be given to the shop drawings until the Contractor certifies that all openings, including those for mechanical and electrical service, are shown. If, during construction, additional masonry openings are required, resubmit the approved shop drawings with the additional openings shown along with the proposed changes. Clearly highlight location of these additional openings. Provide wall elevation drawings with minimum scale of 1/4 inch per foot. Submit drawings including plans, elevations, and details of wall reinforcement; details of reinforcing bars at corners and wall intersections; offsets; tops, bottoms, and ends of walls; control and expansion joints; lintels; and wall openings.

Clean reinforcement of loose, flaky rust, scale, grease, mortar, grout, and other coatings that might destroy or reduce its bond prior to placing grout. Do not use bars with kinks or bends not shown on the approved shop drawings. Place reinforcement prior to grouting. Unless otherwise indicated, extend vertical wall reinforcement to within 2 inches of tops of walls.

3.4.1.2 Positioning Bars

- a. Accurately place vertical bars within the cells at the positions indicated on the drawings. A minimum clearance of 1/2 inch shall be maintained between the bars and masonry units. Provide minimum clearance between parallel bars of 1/2 inch between the bars and masonry units for coarse grout and a minimum clearance of 1/4 inch between the bars and masonry units for fine grout. Provide minimum clearance between parallel bars of 1 inch or one diameter of the reinforcement, whichever is greater. Vertical reinforcement may be held in place using bar positioners located near the ends of each bar and at intermediate intervals of not more than 192 diameters of the reinforcement or by other means to prevent displacement beyond permitted tolerances. As masonry work progresses, secure vertical reinforcement to prevent displacement beyond allowable tolerances.
- b. Position horizontal reinforcing bars as indicated. Stagger splices in adjacent horizontal bars, unless otherwise indicated.
- c. Form splices by lapping bars as indicated. Do not cut, bend or eliminate reinforcing bars. Foundation dowel bars may be field-bent when permitted by TMS MSJC.

3.4.1.3 Splices of Bar Reinforcement

Lap splice reinforcing bars as indicated. When used, provide welded or mechanical connections that develop at least 125 percent of the specified yield strength of the reinforcement.

3.4.2 Placing Grout

3.4.2.1 General

Fill cells containing reinforcing bars with grout. Solidly grout hollow masonry units in walls or partitions supporting plumbing, heating, or other mechanical fixtures, voids at door and window jambs, and other indicated spaces. Solidly grout cells under lintel bearings on each side of openings for full height of openings. Solidly grout walls below grade, lintels, and bond beams. Units other than open end units may require grouting each course to preclude voids in the units.

Discard site-mixed grout that is not placed within 1-1/2 hours after water is first added to the batch or when the specified slump is not met without adding water after initial mixing. Discard ready-mixed grout that does not meet the specified slump without adding water other than water that was added at the time of initial discharge. Allow sufficient time between grout lifts to preclude displacement or cracking of face shells of masonry units. Provide a grout shear key between lifts when grouting is delayed and the lower lift loses plasticity. If blowouts, flowouts, misalignment, or cracking of face shells should occur during construction, tear down the wall and rebuild.

3.4.2.2 Grout Holes and Cleanouts

3.4.2.2.1 Grout Holes

Provide grouting holes in slabs, spandrel beams, and other in-place overhead construction. Locate holes over vertical reinforcing bars or as required to facilitate grout fill in bond beams. Provide additional

openings spaced not more than 16 inches on centers where grouting of hollow unit masonry is indicated. From such openings not less than 4 inches in diameter or 3 by 4 inches in horizontal dimensions. Upon completion of grouting operations, plug and finish grouting holes to match surrounding surfaces.

3.4.2.2.2 Cleanouts for Hollow Unit Masonry Construction

For hollow masonry units, provide cleanout holes at the bottom of every grout pour in cores containing vertical reinforcement when the height of the grout pour exceeds 5 feet 4 inches. Where all cells are to be grouted, construct cleanout courses using bond beam units in an inverted position to permit cleaning of all cells. Provide cleanout holes at a maximum spacing of 32 inches where all cells are to be filled with grout.

Establish a new series of cleanouts if grouting operations are stopped for more than 4 hours. Provide cleanouts not less than 3 by 3 inch by cutting openings in one face shell. Manufacturer's standard cutout units may be used at the Contractor's option. Do not cleanout holes until masonry work, reinforcement, and final cleaning of the grout spaces have been completed and inspected. For walls which will be exposed to view, close cleanout holes in an approved manner to match surrounding masonry.

3.4.2.3 Grout Placement

A grout pour is the total height of masonry to be grouted prior to erection of additional masonry. A grout lift is an increment of grout placement within a grout pour. A grout pour is filled by one or more lifts of grout.

- a. Lay masonry to the top of a pour permitted by TMS MSJC Table 7, based on the size of the grout space and the type of grout. Prior to grouting, remove masonry protrusions that extend 1/2 inch or more into cells or spaces to be grouted. Provide grout holes and cleanouts in accordance with paragraph GROUT HOLES AND CLEANOUTS above when the grout pour height exceeds 5 feet 4 inches. Hold reinforcement, bolts, and embedded connections rigidly in position before grouting is started. Do not prewet concrete masonry units.
- b. Place grout using a hand bucket, concrete hopper, or grout pump to fill the grout space without segregation of aggregate. Operate grout pumps to produce a continuous stream of grout without air pockets, segregation, or contamination.
- c. If the masonry has cured at least 4 hours, grout slump is maintained between 10 to 11 inches, and no intermediate reinforced bond beams are placed between the top and bottom of the pour height, place conventional grout in lifts not exceeding 12 feet 8 inches. For the same curing and slump conditions but with intermediate bond beams, limit conventional grout lift to the bottom of the lowest bond beam that is more than 5 feet 4 inches above the bottom of the lift, but do not exceed 12 feet 8 inches. If masonry has not cured at least 4 hours or grout slump is not maintained between 10 to 11 inches, place conventional grout in lifts not exceeding 5 feet 4 inches.
- d. Consolidate conventional grout lift and reconsolidate after initial settlement before placing next lift. For grout pours that are 12 inches or less in height, consolidate and reconsolidate grout by mechanical vibration or puddling. For grout pours that are greater

than 12 inches in height, consolidate and reconsolidate grout by mechanical vibration. Apply vibrators at uniformly spaced points not further apart than the visible effectiveness of the machine. Limit duration of vibration to time necessary to produce satisfactory consolidation without causing segregation. If previous lift is not permitted to set, dip vibrator into previous lift. Do not insert vibrators into lower lifts that are in a semi-solidified state. If lower lift sets prior to placement of subsequent lift, form a grout key by terminating grout a minimum of 1-1/2 inch below a mortar joint. Vibrate each vertical cell containing reinforcement in partially grouted masonry. Do not form grout keys within beams.

- e. If the masonry has cured 4 hours, place self-consolidating grout (SCG) in lifts not exceeding the pour height. If masonry has not cured for at least 4 hours, place SCG in lifts not exceeding 5 feet 4 inches. Do not mechanically consolidate self-consolidating grout. Place self-consolidating grout in accordance with manufacturer's recommendations.
- f. Upon completion of each day's grouting, remove waste materials and debris from the equipment, and dispose of outside the masonry.

3.4.3 Joint Reinforcement Installation

Install joint reinforcement at 16 inches on center unless otherwise indicated. Lap joint reinforcement not less than 6 inches. Install prefabricated sections at corners and wall intersections. Place the longitudinal wires of joint reinforcement in mortar beds to provide not less than 5/8 inch cover to either face of the unit.

3.4.4 Bond Beams

Reinforce and grout bond beams as indicated and as described in paragraphs above. Install grout barriers under bond beam units to retain the grout as required, unless wall is fully grouted or solid bottom units are used. For high lift grouting in partially grouted masonry, provide grout retaining material on the top of bond beams to prevent upward flow of grout. Ensure that reinforcement is continuous, including around corners, except through control joints or expansion joints, unless otherwise indicated.

3.5 FIELD QUALITY CONTROL

3.5.1 Tests

3.5.1.1 Field Testing of Mortar

Perform mortar testing at the following frequency: 2 times per day. For each required mortar test, provide a minimum of three mortar samples. Perform initial mortar testing prior to construction for comparison purposes during construction.

Prepare and test mortar samples for mortar aggregate ratio in accordance with ASTM C780 Appendix A4. Prepare and test mortar compressive strength specimens in accordance with ASTM C780 Appendix A6.

3.5.1.2 Field Testing of Grout

- a. Perform grout testing at the following frequency: 2 times per day.

For each required grout property to be evaluated, provide a minimum of three specimens.

- b. Sample and test conventional and self-consolidating grout for compressive strength and temperature in accordance with ASTM C1019.
- c. Evaluate slump in conventional grout in accordance with ASTM C1019.
- d. Evaluate slump flow and visual stability index of self-consolidating grout in accordance with ASTM C1611/C1611M.

3.5.1.3 Prism Tests

Perform at least one prism test sample for each 5,000 square feet of wall but not less than three such tests for any building. Evaluate three prisms in each test. Fabricate, store, handle, and test prisms in accordance with ASTM C1314.

Seven-day tests may be used provided the relationship between the 7- and 28-day strengths of the masonry is established by the tests of the materials used. If the compressive strength of any prism falls below the specified value by more than 500 psi, take steps to assure that the load-carrying capacity of the structure is not jeopardized. If the likelihood of low-strength masonry is confirmed and computations indicate that the load-carrying capacity may have been significantly reduced, tests of cores drilled, or prisms sawed, from the area in question may be required. In such case, take three specimens for each prism test more than 500 psi below the specified value. Masonry in the area in question will be considered structurally adequate if the average compressive strength of three specimens is equal to or exceeds the specified value. Additional testing of specimens extracted from locations represented by erratic core or prism strength test results will be permitted.

3.6 POINTING AND CLEANING

After mortar joints have attained their initial set, but prior to hardening, completely remove mortar and grout daubs and splashings from masonry-unit surfaces that will be exposed or painted. Before completion of the work, rake out defects in joints of masonry to be exposed or painted, fill with mortar, and tool to match existing joints. Immediately after grout work is completed, remove scum and stains that have percolated through the masonry work using a low pressure stream of water and a stiff bristled brush. Do not clean masonry surfaces, other than removing excess surface mortar, until mortar in joints has hardened. Leave masonry surfaces clean, free of mortar daubs, dirt, stain, and discoloration, including scum from cleaning operations, and with tight mortar joints throughout. Do not use metal tools and metal brushes for cleaning.

3.6.1 Dry-Brushing Concrete Masonry

Dry brush exposed concrete masonry surfaces at the end of each day's work and after any required pointing, using stiff-fiber bristled brushes.

3.7 PROTECTION

Protect facing materials against staining. Cover top of walls with nonstaining waterproof covering or membrane to protect from moisture intrusion when work is not in progress. Continue covering the top of the unfinished walls until the wall is waterproofed. Extend covering a

minimum of 2 feet down on each side of the wall and hold securely in place. Before starting or resuming work, clean top surface of masonry in place of loose mortar and foreign material.

-- End of Section --

SECTION 26 05 19

INSULATED WIRE AND CABLE

PART 1 GENERAL

1.1 REFERENCES

The publications listed below form a part of this specification to the extent referenced. The publications are referred to within the text by the basic designation only.

INSTITUTE OF ELECTRICAL AND ELECTRONICS ENGINEERS (IEEE)

IEEE 1202 (2006; R 2012; CORR 1 2012)
Flame-Propagation Testing of Wire and Cable

INSULATED CABLE ENGINEERS ASSOCIATION (ICEA)

ICEA S-58-679 (2014) Control, Instrumentation and
Thermocouple Extension Conductor
Identification

ICEA T-30-520 (1986) Conducting Vertical Cable Tray
Flame Tests with Theoretical Heat Input
Rate of 70,000 B.T.U./Hour

NATIONAL ELECTRICAL MANUFACTURERS ASSOCIATION (NEMA)

ANSI/NEMA WC 71/ICEA S-96-659 (2014) Standard for Nonshielded Cables
Rated 2001-5000 Volts for use in the
Distribution of Electric Energy

NEMA WC 26 (2008) Binational Wire and Cable Packaging
Standard

NEMA WC 57 (2014) Standard for Control, Thermocouple
Extension, and Instrumentation Cables

NEMA WC 70 (2009) Power Cable Rated 2000 V or Less
for the Distribution of Electrical
Energy--S95-658

NEMA WC 74/ICEA S-93-639 (2012) 5-46 kV Shielded Power Cable for
Use in the Transmission and Distribution
of Electric Energy

NATIONAL FIRE PROTECTION ASSOCIATION (NFPA)

NFPA 70 (2020; ERTA 20-1 2020; ERTA 20-2 2020; TIA
20-1; TIA 20-2; TIA 20-3; TIA 20-4)
National Electrical Code

UNDERWRITERS LABORATORIES (UL)

UL 44 (2018; Reprint May 2021) UL Standard for

Safety Thermoset-Insulated Wires and Cables

UL 83	(2017; Reprint Mar 2020) UL Standard for Safety Thermoplastic-Insulated Wires and Cables
UL 1685	(2015) UL Standard for Safety Vertical-Tray Fire-Propagation and Smoke-Release Test for Electrical and Optical-Fiber Cables
UL 2556	(2015) UL Standard for Safety Wire and Cable Test Methods

1.2 SUBMITTALS

Government approval is required for submittals with a "G" classification. Submittals not having a "G" classification are for information only. When used, a code following the "G" classification identifies the office that will review the submittal for the Government. Submit the following in accordance with Section 01 33 00 SUBMITTAL PROCEDURES:

SD-03 Product Data

Wire and Cable; G

Conductors; G

Cable Manufacturing Data

SD-06 Test Reports

Test Report(s), Inspection Report(s), and Verification Report(s); G

1.3 DELIVERY, STORAGE, AND HANDLING

Furnish cables on reels or coils. Each cable and the outside of each reel or coil, must be plainly marked or tagged to indicate the cable length, voltage rating, conductor size, and manufacturer's lot number and reel number. Each coil or reel of cable must contain only one continuous cable without splices. Cables for exclusively dc applications, as specified in paragraph "High-Voltage Test Source," must be identified as such. Shielded cables rated 2,001 volts and above must be reeled and marked in accordance with NEMA WC 26, as applicable. Reels must remain the property of the Contractor.

PART 2 PRODUCTS

2.1 MATERIALS

2.1.1 Wire Table

Furnish wire and cable in accordance with the requirements of the detailed requirements specified herein.

2.1.2 Rated Circuit Voltages

All power wire and cable must have minimum rated circuit voltages in accordance with NEMA WC 70, ANSI/NEMA WC 71/ICEA S-96-659, or

NEMA WC 74/ICEA S-93-639 as applicable. Power wire and cable for circuit voltages rated 0-600 volts must be rated not less than 600 volts. Control wire and cable must have minimum rated circuit voltages in accordance with NEMA WC 57, but must be rated 600 volts if routed in raceway with other conductors that are rated 600 volts.

2.1.3 Conductors

2.1.3.1 Material for Conductors

Conductors must conform to all the applicable requirements of NEMA WC 57, NEMA WC 70, as applicable. Copper conductors must be annealed copper material and they may be bare, or tin- or lead-alloy-coated, if required by the type of insulation used. Aluminum conductors is not acceptable.

2.1.3.2 Size

Minimum wire size must be No. 12 AWG for power and lighting circuits; No. 10 AWG for current transformer secondary circuits; No. 14 AWG for potential transformer, relaying, and control circuits.

2.1.3.3 Stranding

Conductor stranding classes cited herein must be as defined for control conductors in NEMA WC 57 or as defined for 0-2,000 volts power conductors in NEMA WC 70, as applicable. Lighting conductors No. 10 AWG and smaller must be solid or have Class B stranding. Any conductors used between stationary and moving devices, such as hinged doors or panels, must have Class H or K stranding. All other conductors must have Class B or C stranding, except that conductors as shown, or in the schedule, as No. 12 AWG may be 19 strands of No. 25 AWG, and conductors shown as No. 10 AWG may be 19 strands of No. 22 AWG.

2.1.3.4 Conductor Shielding

Use conductor shielding conforming to NEMA WC 57 for control wire and cable as applicable.

2.1.4 Insulation

2.1.4.1 Insulation Material

Unless specified otherwise or required by NFPA 70, wires in conduit, other than service entrance, must be 600-volt, Type THWN/THHN conforming to UL 83 or Type XHHW or RHW conforming to UL 44]. Insulation for control wire and cable must meet the requirements of NEMA WC 57. Insulation requirements for wire and cable rated less than 2,000 volts must meet the requirements of NEMA WC 70.

2.1.4.2 Insulation Thickness

The insulation thickness for each conductor must be based on its rated circuit voltage.

2.1.4.2.1 Power Cables, 2,000 Volts and Below

The insulation thickness for single-conductor and multiple-conductor power cables rated 2,000 volts and below must be as required by NEMA WC 70, as applicable. Some thicknesses of NEMA WC 70 will be permitted only for

single-conductor cross-linked thermosetting polyethylene insulated cables without a jacket. NEMA WC 70 ethylene-propylene rubber-insulated conductors must have a jacket.

2.1.4.2.2 Single-Conductor and Multiple-Conductor Control Cables

The insulation thickness of control conductor sizes 22 AWG to 10 AWG used for control and related purposes must be as required by NEMA WC 57, as applicable. Control conductors larger than 10 AWG must be as required by NEMA WC 70.

2.1.5 Jackets

All cables must have jackets meeting the requirements of NEMA WC 57, NEMA WC 70, ANSI/NEMA WC 71/ICEA S-96-659, and NEMA WC 74/ICEA S-93-639, as applicable, and as specified herein. Individual conductors of multiple-conductor cables must be required to have jackets only if they are necessary for the conductor to meet other specifications herein. Jackets of single-conductor cables and of individual conductors of multiple-conductor cables, except for shielded cables, must be in direct contact and adhere or be vulcanized to the conductor insulation. Multiple-conductor cables and shielded single-conductor cables must be provided with a common overall jacket, which must be tightly and concentrically formed around the core. Repaired jacket defects found and corrected during manufacturing are permitted if the cable, including jacket, afterward fully meets these specifications and the requirements of the applicable standards.

2.1.5.1 Jacket Material

The jacket must be one of the materials listed below. Polyvinyl chloride compounds will not be permitted. Variations from the materials required below will be permitted only if approved for each specific use, upon submittal of sufficient data to prove that they exceed all specified requirements for the particular application.

2.1.5.1.1 General Use

Heavy-duty black neoprene	NEMA WC 70
Heavy-duty chlorosulfonated polyethylene	NEMA WC 57, NEMA WC 70
Heavy-duty cross-linked (thermoset) chlorinated polyethylene	NEMA WC 70

2.1.5.1.2 Accessible Use Only, 2,000 Volts or Less

Cables installed where they are entirely accessible, such as cable trays

and raceways with removable covers, or where they pass through less than 10 feet of exposed conduit only, must have jackets of one of the materials in item "a. General Use" or one of the following:

General-purpose neoprene	NEMA WC 70
Black polyethylene (MDPE)	NEMA WC 57, NEMA WC 70
Thermoplastic chlorinated polyethylene	NEMA WC 70

2.1.5.2 Jacket Thickness

The minimum thickness of the jackets must be not less than 80 percent of the respective nominal thicknesses specified below.

2.1.5.2.1 Multiple-Conductor Cables

Thickness of the jackets of the individual conductors of multiple-conductor cables must be as required by NEMA WC 57, NEMA WC 70, as applicable and must be in addition to the conductor insulation thickness required by the applicable respective NEMA publication for the insulation used. Thickness of the outer jackets and associated coverings of the assembled multiple-conductor cables must be as required by NEMA WC 57, NEMA WC 70, as applicable.

2.1.5.2.2 Single-Conductor Cables

Single-conductor cables must have a jacket thickness as specified in NEMA WC 57, NEMA WC 70, as applicable.

2.1.6 Multiple-Conductor Cables

Grounding conductor(s) conforming to NEMA WC 57, NEMA WC 70, as applicable must be furnished for each multiple-conductor cable. Assembly and cabling must be as specified in paragraph CABLING.

2.2 CABLE IDENTIFICATION

2.2.1 Color-Coding

Insulation of individual conductors of multiple-conductor cables must be color-coded in accordance with ICEA S-58-679, except that colored braids will not be permitted. Only one color-code method must be used for each cable construction type. Control cable color-coding must be [in accordance with ICEA S-58-679. Power cable color-coding must be black for Phase A, red for Phase B, blue for Phase C, white for grounded neutral, and green for an insulated grounding conductor, if included. Other individual conductors must be color-coded as indicated, but such color-coding may be accomplished by applying colored plastic tapes or colored sleeves at terminations.

2.2.2 Cabling

Individual conductors of multiple-conductor cables must be assembled with flame-and moisture-resistant fillers, binders, and a lay conforming to NEMA WC 57, NEMA WC 70. Flat twin cables are prohibited. Fillers must be used in the interstices of multiple-conductor round cables with a common covering where necessary to give the completed cable a substantially circular cross section. Fillers must be non-hygroscopic material, compatible with the cable insulation, jacket, and other components of the cable. The rubber-filled or other approved type of binding tape must consist of a material that is compatible with the other components of the cable and must be lapped at least 10 percent of its width.

2.2.3 Dimensional Tolerance

The outside diameters of single-conductor cables and of multiple-conductor cables must not vary more than 5 percent and 10 percent, respectively, from the manufacturer's published catalog data.

PART 3 EXECUTION

3.1 INSTALLATION INSTRUCTIONS

Submit cable manufacturing data as requested. The following information must be provided by the cable manufacturer for each size, conductor quantity, and type of cable furnished:

- a. Minimum bending radius, in inches - For multiple-conductor cables, this information must be provided for both the individual conductors and the multiple-conductor cable.
- b. Pulling tension and sidewall pressure limits, in pounds.
- c. Instructions for stripping semiconducting insulation shields, if furnished, with minimum effort without damaging the insulation.
- d. Upon request, compatibility of cable materials and construction with specific materials and hardware manufactured by others must be stated. Also, if requested, recommendations must be provided for various cable operations, including installing, splicing, terminating, etc.

3.2 TEST REPORT(S), INSPECTION REPORT(S), AND VERIFICATION REPORT(S)

3.2.1 Cable Data

Do not begin any wire and cable fabrication until materials are submitted and approved by the Contracting Officer. Submit cable data for approval including, but not limited to, dimensioned sketches showing cable construction and sufficient additional data to show that wire and cable meet the requirements of this Section.

3.2.2 Inspection and Tests

Inspection and tests of wire and cable furnished under these specifications must be made by and at the plant of the manufacturer and the manufacturer must provide certification and certification reports of completed inspections and completed tests. The Government may require or perform further tests before or after installation. Testing in general

must comply with NEMA WC 57, NEMA WC 70 as applicable. Specific tests required for particular materials, components, and completed cables must be as specified in the sections of the above standards applicable to those materials, components, and cable types. Tests must also be performed in accordance with the additional requirements specified below. Submit 6 certified copies of test reports.

3.2.2.1 Flame Tests

All multiple-conductor and single-conductor cable assemblies must pass either the vertical cable tray flame tests required by ICEA T-30-520, the vertical tray flame propagation test requirements of UL 1685 and IEEE 1202, the wire and cable burning characteristics test of the UL 2556 VW-1 Test, or for control cables only the flame test as required by NEMA WC 57. If such tests, however, have previously been made on identical cables, these tests need not be repeated. Instead, certified reports of the original qualifying tests must be submitted. In this case the reports furnished under paragraph "Reports," must include information, identify critical information, and verify that all of each cable's materials, construction, and dimensions are the same as those in the qualifying tests.

3.2.2.2 Independent Tests

The Government may make visual inspections, continuity or resistance checks, insulation resistance readings, power factor tests, or dc high potential tests at field test values. A cable's failure to pass these tests and inspections, or failure to produce readings consistent with acceptable values for the application, will be grounds for rejection of the cable.

3.2.2.3 Reports

Furnish results of tests. No wire or cable must be shipped until authorized. Lot number and reel or coil number of wire and cable tested must be indicated on the test reports.

WIRE TABLE

Item No.	Size, AWG or kcmil	No. of Conds.	Rated Circuit Voltage	Stranding	Comments	Quantity, lin ft
Class [_____] stranding may be substituted for [_____] where indicated by "**".						

-- End of Section --

SECTION 26 05 26

GROUNDING AND BONDING FOR ELECTRICAL SYSTEMS

PART 1 GENERAL

Section 33 71 02 UNDERGROUND DISTRIBUTION SYSTEM applies to work specified in this section.

1.1 REFERENCES

The publications listed below form a part of this specification to the extent referenced. The publications are referred to within the text by the basic designation only.

AMERICAN WELDING SOCIETY (AWS)

AWS A3.0M/A3.0 (2020) Standard Welding Terms and Definitions

AWS B2.1/B2.1M (2014; Errata 2015) Specification for Welding Procedure and Performance Qualification

ASTM INTERNATIONAL (ASTM)

ASTM B3 (2013) Standard Specification for Soft or Annealed Copper Wire

ASTM B8 (2011; R 2017) Standard Specification for Concentric-Lay-Stranded Copper Conductors, Hard, Medium-Hard, or Soft

ASTM B187/B187M (2020) Standard Specification for Copper, Bus Bar, Rod and Shapes and General Purpose Rod, Bar and Shapes

INSTITUTE OF ELECTRICAL AND ELECTRONICS ENGINEERS (IEEE)

IEEE 81 (2012) Guide for Measuring Earth Resistivity, Ground Impedance, and Earth Surface Potentials of a Ground System

IEEE C2 (2017; Errata 1-2 2017; INT 1 2017) National Electrical Safety Code

NATIONAL ELECTRICAL MANUFACTURERS ASSOCIATION (NEMA)

ANSI/NEMA GR 1 (2007) Grounding Rod Electrodes and Grounding Rod Electrode Couplings

NATIONAL FIRE PROTECTION ASSOCIATION (NFPA)

NFPA 70 (2020; ERTA 20-1 2020; ERTA 20-2 2020; TIA 20-1; TIA 20-2; TIA 20-3; TIA 20-4) National Electrical Code

UNDERWRITERS LABORATORIES (UL)

UL 467	(2013; Reprint Jun 2017) UL Standard for Safety Grounding and Bonding Equipment
UL 546	(2008) UL Outline of Investigation for Conductor Termination Compounds

1.2 SUBMITTALS

Government approval is required for submittals with a "G" classification. Submittals not having a "G" classification are for information only. When used, a code following the "G" classification identifies the office that will review the submittal for the Government. Submit the following in accordance with Section 01 33 00 SUBMITTAL PROCEDURES:

SD-03 Product Data

Ground Rods; G

Ground Wires; G

Connectors and Fasteners; G

Test Wells; G

Conductive Corrosion Inhibiting Compounds; G

Ground Buses; G

SD-06 Test Reports

Bond Resistance Test; G

Ground Resistance Tests; G

Equipment Continuity Test; G

SD-07 Certificates

Ground Resistance Test Equipment; G

Micro-Ohmmeter Test Equipment; G

SD-11 Closeout Submittals

Record Drawings

1.3 QUALITY CONTROL

1.3.1 Regulatory Requirements

In each of the publications referred to herein, consider the advisory provisions to be mandatory, as though the word, "shall" had been substituted for "should" wherever it appears. Interpret references in these publications to the "authority having jurisdiction," or words of similar meaning, to mean the Contracting Officer. Ensure equipment, materials, installation, and workmanship are in accordance with the mandatory and advisory provisions of NFPA 70, IEEE C2 unless more

stringent requirements are specified or indicated.

1.3.2 Standard Products

Provide materials and equipment that are products of manufacturers regularly engaged in the production of such products which are of equal material, design and workmanship. Provide products which have been in satisfactory commercial or industrial use for 2 years prior to bid opening. Ensure the 2-year period includes applications of equipment and materials under similar circumstances and of similar size. Ensure the product has been on sale on the commercial market through advertisements, manufacturers' catalogs, or brochures during the 2-year period. Where two or more items of the same class of equipment are required, these items must be products of a single manufacturer.

1.3.3 Ground Resistance Test Equipment

Provide combination 3-point and 4-point type ground resistance test equipment specifically designed for grounding electrode resistance and soil resistivity tests. Submit proof of current equipment calibration with test equipment product data.

1.3.4 Micro-Ohmmeter Test Equipment

Perform circuit and bond resistance tests using a micro-ohmmeter with the following characteristics:

- a. Resistance range selectable and capable of measuring to 10 micro-Ohms using a minimum of 1 ampere of test current.
- b. Positive and negative test leads of the 2-wire balanced type. Provide both clamp and probe type connections to allow measurements across all bonded surfaces. Provide long length balanced test lead to allow measurements from a bonding location to the nearest test well.

Submit proof of current equipment calibration with test equipment product data.

PART 2 PRODUCTS

Submit material, equipment, and fixture lists for grounding systems, including manufacturer's style or catalog numbers, specification and drawing reference numbers, warranty information, and fabrication site information.

2.1 MATERIALS

2.1.1 Ground Rods

Provide ground rods of [copper][copper-clad steel] conforming to UL 467 and ANSI/NEMA GR 1. Ensure ground rods are not less than 3/4 inch in diameter and 10 feet in length.

Provide ground rods and ground rod sections die-stamped near the top with the name or trademark of the manufacturer and the length of the segment in feet.

2.1.2 Ground Wires

2.1.2.1 Bare

Provide annealed bare copper, Class "B" stranded ground and bond wires in accordance with ASTM B8 for wires #4 AWG and larger and solid in accordance with ASTM B3 for wires #6 AWG and smaller. Provide conductors with 98 percent conductivity and sized wires in accordance with the requirements of NFPA 70 and NFPA 780.

2.1.2.2 Insulated

Ensure insulated conductors conform to the requirements of Section 26 05 00.00 40 COMMON WORK RESULTS FOR ELECTRICAL.

Where installed in conduit as part of a complete circuit provide conductors with green insulation for sizes #8 AWG and smaller and with green phase tape at each end and in each junction box for sizes #6 AWG and larger.

2.1.2.3 Straps/Jumpers

Provide copper bonding straps and jumpers with a cross-sectional area of not less than as indicated. Ensure bonding straps and jumpers for shock-mounted devices with hinged joints are made of woven-wire braid wire.

2.1.3 Connectors and Fasteners

2.1.3.1 Exothermic Welds

Ensure the molds, materials and powder charges used to make exothermic welds are the standard product of a single manufacturer and listed by the manufacturer for use on the specific type, size, quantity and configuration of conductors to which the weld is applied.

2.1.3.2 Irreversible Compression Lugs

Provide irreversible compression lug type connectors manufactured from tin-plated copper and installed using a hydraulic compression tool and die to apply correct, uniformly distributed, circumferential pressure. Ensure tools and dies are as recommended by the irreversible compression lug type connector manufacturer. Use an embossing die code or other standard method to provide visible indication that a connector has been adequately compressed onto the conductor. Apply irreversible compression lug type connectors in strict accordance with the manufacturer's written instructions and published installation instructions. Use 2-hole lug type connectors for connections to NEMA cable pads and bus bars, and single-hole connectors otherwise.

2.1.3.3 Mechanical

Provide split bolt and clamp style mechanical type connectors manufactured from bronze, listed by the manufacturer as suitable for direct burial use. Ensure mechanical type connectors are applied in strict accordance with the manufacturer's published installation instructions.

2.1.3.4 Fasteners

Provide bolts, nuts, washers, lock washers, and associated fasteners used

for grounding and bonding connections manufactured of bronze. Where fasteners contact dissimilar metals, apply conductive oxide-inhibiting compound.

2.1.4 Test Wells

Provide test wells that are H2O rated, precast reinforced concrete, circular, with open bottom and concrete or cast iron lid/frame. Ensure test wells have inside dimensions of not less than 12 inches in diameter by 24 inches deep. Provide test well lid with cast "GROUND" legend.

2.1.5 Conductive Corrosion Inhibiting Compounds

Provide conductive corrosion inhibiting compounds UL Listed in accordance with UL 546, listed by the manufacturer as suitable for the application, and suitable for all aluminum and copper conductor/connector applications. Ensure conductive corrosion inhibiting compounds inhibit oxidation at the conductor/connector interface and have no deleterious effect on the conductor/connector metal or EPDM, natural rubber, or polyethylene insulating materials.

2.1.6 Ground Buses

Provide solid copper ground buses conforming to ASTM B187/B187M with minimum dimensions of 0.25 inches thick, 4 inches wide, and 12 inches in length or as indicated. Ensure ground buses are equipped with two UL Recognized red 1000V rated insulated standoffs and stainless steel mounting brackets.

Provide grounding buses with predrilled NEMA hole configuration as indicated.

PART 3 EXECUTION

3.1 INSTALLATION

Install grounding systems in accordance with NFPA 70, NFPA 780 and IEEE C2, and as indicated.

Bond exposed non-current-carrying metallic parts of electrical equipment and metallic raceway systems to ground.

Bond grounding conductors in metallic and non-metallic raceways to ground. Make ground connections at equipment and to ground rods as indicated. Interconnect all grounding media in or on the structure to provide a common ground potential. This includes lightning protection, electrical service, telecommunications system grounds, as well as underground metallic piping systems.

Bond wiring system neutrals to ground in accordance with the requirements of NFPA 70. Where ground fault protection is employed, ensure that connection of ground and neutral does not interfere with correct operation of fault protection.

3.1.1 Ground Rods

Install ground rods so that the top of the rod is 4 inches above grade.

3.1.2 Conductors

Install bare or insulated conductors as indicated. Install bare conductors where not specifically identified as bare or insulated except where installed in conduit with associated phase conductors. Install insulated conductors in conduit with insulation of the same material as the associated phase conductors with which it is installed.

Provide straps/jumpers across joints subject to vibration. Install strap/jumper such that vibration will not change its electrical characteristics. Apply strap/jumper to the metallic structure on each side of the joint; do not penetrate any adjacent parts. Install straps/jumpers in areas that are accessible for maintenance. Install strap/jumper such that it does not restrict the movement of the metallic structures to which it is connected. Install strap/jumper such that it does not weaken the metallic structures to which it is attached. Do not connect two or more straps/jumpers in series.

3.1.3 Ground Buses

Install ground busses in accordance with manufacturer's instructions.

3.1.4 Equipment Grounding

Install ground systems for power.

3.1.4.1 Equipment and Enclosure Bonding

Bond each metallic enclosure and all electrical equipment to ground. Make at least one copper connection from the system ground point to one or more enclosures in the area such that all enclosures and equipment provide a low-impedance path to ground when properly bonded together.

In addition to the green colored equipment grounding conductor required in each raceway and sized in accordance with Table 250.122 of NFPA 70, bond each switchboard enclosure, transformer housing, and other electrical equipment, to the grounding system with a stranded copper conductor, routed external to the feeder raceway.

3.1.4.2 Bonding of Conduit and Raceway Systems

Bond all metal conduit, fittings, junction boxes, outlet boxes, armored and metal sheathed cable, and other raceways. Ensure adequate electrical contact at the joints and terminations. Ensure metallic raceway systems have electrical continuity with equipment. Individually and directly connect equipment to the building ground, independent of the raceway system.

For rigid metal conduit and terminations, ensure threaded connections are wrench-tight with no exposed threads. Ream all ends of the conduit to remove burrs and rough edges. Bond conduits entering boxes and enclosures to the box with bonding-type locknuts, one outside and one inside. Locknuts that gouge into the metal box when tightened are not acceptable.

Conduit systems that are interrupted by PVC dielectric links are bonded separately on either side of the link. Do not jumper the dielectric link.

Install flexible metal conduit with an integral grounding conductor.

3.1.5 Bonding Materials And Methods

Accomplish bonding of metal surfaces by welding or structural joining methods.

3.1.5.1 Welding

Weld using the exothermic process with procedures conforming to AWS A3.0M/A3.0, AWS B2.1/B2.1M, and manufacturer's recommendation. Where dissimilar metals are to be joined via exothermic weld, follow the weld kit manufacturer's recommendations and published instructions. Ensure connections between dissimilar metals do not produce galvanic action in accordance with MIL-STD-889.

Use welding processes of the exothermic fusion type that makes a connection without corroding or loosening. Ensure process joins all strands and does not cause the parts to be damaged or weakened. Completed connection or joint is equal or larger in size than the conductors joined and has the same current-carrying capacity as the largest conductor. Paint the buried ground connections with a bitumastic paint.

3.1.5.2 Cleaning of Bonding Surfaces

Thoroughly clean surfaces that comprise the bond before joining. Apply an appropriate abrasive with gentle and uniform pressure to ensure a smooth and uniform surface. Do not remove excessive metal from the surface. Clean clad metals in such a manner that the cladding material is not penetrated by the cleaning process. Then clean bare metal with an appropriate solvent to remove any grease, oil, dirt, corrosion preventives, and other contaminants. Bond to the cleaned area within one hour after cleaning. Seal joint and refinish the exposed surfaces within two hours of exposure to prevent oxidation. When additional time is required, apply a corrosion preventive compound until the area can be refinished.

3.1.5.3 Protection of Finished Bonds

Protect finished bonds by painting to match the original finish after the bond is made.

3.2 FIELD QUALITY CONTROL

The requirements of Section 26 08 00 APPARATUS COORDINATION, INSPECTION AND TESTING apply to this section.

Perform the following tests in the presence of the Contracting Officer. Furnish test equipment and personnel and submit written results of each test. Notify the Contracting Officer at least 14 calendar working days prior to each test.

Submit written results of each test to Contracting Officer for review and approval. Document each location where test is performed, the field conditions at the time of the test, the measured results of the test, and whether the measured results "PASSED" or "FAILED" relative to specified pass/fail performance criteria.

Perform rework to correct FAILED conditions at no additional cost to the Government.

3.2.1 Bond Resistance Test

Resistance of any bond connection cannot exceed 0.5 milliohm. Rework bonds that exceed this resistance at no additional cost to the Government.

3.2.2 Ground Resistance Tests

Make ground resistance and counterpoise tests during dry weather, and no sooner than 48 hours after rainfall. Conduct tests using the ratio method that measures the ratio of the resistance to earth of an auxiliary test electrode to the series resistance of the electrode under test and a second auxiliary electrode. Perform measurements in accordance with IEEE 81.

3.2.3 Ground Isolation Test

Test ground systems for isolation from other ground systems.

3.2.4 Equipment Continuity Test

Test connection from electrical distribution equipment including panelboards, switchboards, transformers, substations, and motor control centers to counterpoise. Measure and record the circuit resistance between electrical equipment ground connections and the counterpoise. The circuit resistance shall not exceed 5 Ohms.

3.3 CLOSEOUT ACTIVITIES

Submit record drawings indicating the location of ground rods, mats, grids, building ground bus, supplementary grounding electrodes, steel building columns, and other metal structures connected to the grounding system.

-- End of Section --

SECTION 26 05 48

SEISMIC PROTECTION FOR ELECTRICAL EQUIPMENT

PART 1 GENERAL

1.1 REFERENCES

The publications listed below form a part of this specification to the extent referenced. The publications are referred to within the text by the basic designation only.

AMERICAN INSTITUTE OF STEEL CONSTRUCTION (AISC)

AISC 325 (2017) Steel Construction Manual

1.2 SYSTEM DESCRIPTION

1.2.1 General Requirements

The requirements for seismic protection measures described in this section shall be applied to the electrical equipment and systems listed below. Structural requirements shall be in accordance with Section 13 48 73 SEISMIC CONTROL FOR MECHANICAL EQUIPMENT.

1.2.2 Electrical Equipment

Electrical equipment shall include the following items to the extent required on the drawings or in other sections of these specifications:

Standby Generators	Transformers
Switchboards (Floor Mounted)	

1.2.3 Electrical Systems

The following electrical systems shall be installed as required on the drawings and other sections of these specifications and shall be seismically protected in accordance with this specification: switchboard, dry-type transformers and standby generators.

1.2.4 Contractor Designed Bracing

Submit copies of the Design Calculations with the Drawings. Calculations shall be approved, certified, stamped and signed by a Registered Professional Engineer. Calculations shall verify the capability of structural members to which bracing is attached for carrying the load from the brace. Design the bracing in accordance with UFC 3-301-01 and additional data furnished by the Contracting Officer. Resistance to lateral forces induced by earthquakes shall be accomplished without consideration of friction resulting from gravity loads. UFC 3-301-01 uses parameters for the building, not for the equipment in the building; therefore, corresponding adjustments to the formulas shall be required. Loadings determined using UFC 3-301-01 are based on strength design;

therefore, AISC 325 shall be used for the design.

1.2.5 Conduits Requiring No Special Seismic Restraints

Seismic restraints may be omitted from electrical conduit less than 3 inches trade size. All other interior conduit, shall be seismically protected as specified.

1.3 EQUIPMENT REQUIREMENTS

Submit detail drawings along with catalog cuts, templates, and erection and installation details, as appropriate, for the items listed. Submittals shall be complete in detail, indicating thickness, type, grade, class of metal, and dimensions; and shall show construction details, reinforcement, anchorage, and installation with relation to the building construction. Submit copies of the design calculations with the detail drawings. Calculations shall be stamped by a registered engineer and shall verify the capability of structural members to which bracing is attached for carrying the load from the brace.

1.3.1 Rigidly Mounted Equipment

The following specific items of equipment: switchboards, dry-type transformers and standby generators to be furnished under this contract shall be constructed and assembled to withstand the seismic forces specified in UFC 3-301-01. Each item of rigid electrical equipment shall be entirely located and rigidly attached on one side only of a building expansion joint. Piping, electrical conduit, etc., which cross the expansion joint shall be provided with flexible joints that are capable of accommodating displacements equal to the full width of the joint in both orthogonal directions.

Engine-Generators
Dry-Type Transformers
Switch Boards

1.4 SUBMITTALS

Government approval is required for submittals with a "G" classification. Submittals not having a "G" classification are for information only. When used, a code following the "G" classification identifies the office that will review the submittal for the Government. Submit the following in accordance with Section 01 33 00 SUBMITTAL PROCEDURES:

SD-02 Shop Drawings

Equipment Requirements

SD-03 Product Data

Equipment Requirements; G

-- End of Section --

SECTION 26 24 13

SWITCHBOARDS

PART 1 GENERAL

1.1 REFERENCES

The publications listed below form a part of this specification to the extent referenced. The publications are referred to within the text by the basic designation only.

AMERICAN NATIONAL STANDARDS INSTITUTE (ANSI)

ANSI C12.1 ((2014; Errata 2016) Electric Meters - Code for Electricity Metering

ASTM INTERNATIONAL (ASTM)

ASTM A240/A240M (2020a) Standard Specification for Chromium and Chromium-Nickel Stainless Steel Plate, Sheet, and Strip for Pressure Vessels and for General Applications

ASTM A780/A780M (2020) Standard Practice for Repair of Damaged and Uncoated Areas of Hot-Dip Galvanized Coatings

ASTM D149 (2020) Dielectric Breakdown Voltage and Dielectric Strength of Solid Electrical Insulating Materials at Commercial Power Frequencies

ASTM D709 (2017) Standard Specification for Laminated Thermosetting Materials

ASTM D1535 (2014; R 2018) Standard Practice for Specifying Color by the Munsell System

INSTITUTE OF ELECTRICAL AND ELECTRONICS ENGINEERS (IEEE)

IEEE 81 (2012) Guide for Measuring Earth Resistivity, Ground Impedance, and Earth Surface Potentials of a Ground System

IEEE 100 (2000; Archived) The Authoritative Dictionary of IEEE Standards Terms

IEEE C2 (2017; Errata 1-2 2017; INT 1 2017) National Electrical Safety Code

IEEE C37.90.1 (2013) Standard for Surge Withstand Capability (SWC) Tests for Relays and Relay Systems Associated with Electric Power Apparatus

IEEE C57.12.28 (2014) Standard for Pad-Mounted Equipment
- Enclosure Integrity

IEEE C57.12.29 (2014) Standard for Pad-Mounted Equipment
- Enclosure Integrity for Coastal
Environments

INTERNATIONAL ELECTRICAL TESTING ASSOCIATION (NETA)

NETA ATS (2021) Standard for Acceptance Testing
Specifications for Electrical Power
Equipment and Systems

NATIONAL ELECTRICAL MANUFACTURERS ASSOCIATION (NEMA)

ANSI/NEMA PB 2.1 (2013) General Instructions for Proper
Handling, Installation, Operation and
Maintenance of Deadfront Distribution
Switchboards Rated 600 V or Less

NEMA ICS 6 (1993; R 2016) Industrial Control and
Systems: Enclosures

NEMA PB 2 (2011) Deadfront Distribution Switchboards

NEMA ST 20 (2014) Dry-Type Transformers for General
Applications

NATIONAL FIRE PROTECTION ASSOCIATION (NFPA)

NFPA 70 (2020; ERTA 20-1 2020; ERTA 20-2 2020; TIA
20-1; TIA 20-2; TIA 20-3; TIA 20-4)
National Electrical Code

UNDERWRITERS LABORATORIES (UL)

UL 467 (2013; Reprint Jun 2017) UL Standard for
Safety Grounding and Bonding Equipment

UL 489 (2016; Rev 2019) UL Standard for Safety
Molded-Case Circuit Breakers, Molded-Case
Switches and Circuit-Breaker Enclosures

UL 891 (2005; Reprint Oct 2012) Switchboards

1.2 RELATED REQUIREMENTS

Section 26 08 00 APPARATUS INSPECTION AND TESTING applies to this section,
with the additions and modifications specified herein.

1.3 DEFINITIONS

Unless otherwise specified or indicated, electrical and electronics terms
used in these specifications, and on the drawings, are as defined in
IEEE 100.

1.4 SUBMITTALS

Government approval is required for submittals with a "G" classification. Submittals not having a "G" classification are for information only. When used, a code following the "G" classification identifies the office that will review the submittal for the Government. Submit the following in accordance with Section 01 33 00 SUBMITTAL PROCEDURES:

SD-02 Shop Drawings

Switchboard Drawings; G

SD-03 Product Data

Switchboard; G

SD-06 Test Reports

Switchboard Production Tests; G

Acceptance Checks and Tests; G

SD-10 Operation and Maintenance Data

Switchboard Operation and Maintenance, Data Package 5; G

SD-11 Closeout Submittals

Assembled Operation and Maintenance Manuals; G

Equipment Test Schedule; G

Request for Settings; G

Required Settings; G

Service Entrance Available Fault Current Label; G

1.5 QUALITY ASSURANCE

1.5.1 Product Data

Include manufacturer's information on each submittal for each component, device and accessory provided with the switchboard including:

- a. Circuit breaker type, interrupting rating, and trip devices, including available settings.
- b. Manufacturer's instruction manuals and published time-current curves (in electronic format) of the main secondary breaker and largest secondary feeder device.

1.5.2 Switchboard Drawings

Include wiring diagrams and installation details of equipment indicating proposed location, layout and arrangement, control panels, accessories, piping, ductwork, and other items that must be shown to ensure a coordinated installation. Identify circuit terminals on wiring diagrams and indicate the internal wiring for each item of equipment and the

interconnection between each item of equipment. Indicate on the drawings adequate clearance for operation, maintenance, and replacement of operating equipment devices. Include the nameplate data, size, and capacity on submittal. Also include applicable federal, military, industry, and technical society publication references on submittals. Include the following:

- a. One-line diagram including breakers[, fuses][, current transformers, and meters].
- b. Outline drawings including front elevation, section views, footprint, and overall dimensions.
- c. Bus configuration including dimensions and ampere ratings of bus bars.
- d. Markings and NEMA nameplate data[, including fuse information (manufacturer's name, catalog number, and ratings)].
- e. Circuit breaker type, interrupting rating, and trip devices, including available settings.
- f. Wiring diagrams and elementary diagrams with terminals identified, and indicating prewired interconnections between items of equipment and the interconnection between the items.
- g. Manufacturer's instruction manuals and published time-current curves (in electronic format) of the main secondary breaker and largest secondary feeder device. Use this information (designer of record) to provide breaker settings that ensures protection and coordination are achieved.

1.5.3 Regulatory Requirements

In each of the publications referred to herein, consider the advisory provisions to be mandatory, as though the word, "shall" or "must" had been substituted for "should" wherever it appears. Interpret references in these publications to the "authority having jurisdiction," or words of similar meaning, to mean the Contracting Officer. Provide equipment, materials, installation, and workmanship in accordance with the mandatory and advisory provisions of NFPA 70 unless more stringent requirements are specified or indicated.

1.5.4 Standard Products

Provide materials and equipment that are products of manufacturers regularly engaged in the production of such products which are of equal material, design and workmanship, and:

- a. Have been in satisfactory commercial or industrial use for 2 years prior to bid opening including applications of equipment and materials under similar circumstances and of similar size.
- b. Have been on sale on the commercial market through advertisements, manufacturers' catalogs, or brochures during the 2-year period.
- c. Where two or more items of the same class of equipment are required, provide products of a single manufacturer; however, the component parts of the item need not be the products of the same manufacturer unless stated in this section.

1.5.4.1 Alternative Qualifications

Products having less than a 2-year field service record will be acceptable if a certified record of satisfactory field operation for not less than 6000 hours, exclusive of the manufacturers' factory or laboratory tests, is furnished.

1.5.4.2 Material and Equipment Manufacturing Date

Products manufactured more than one year prior to date of delivery to site are not acceptable.

1.6 MAINTENANCE

1.6.1 Switchboard Operation and Maintenance Data

Submit Operation and Maintenance Manuals in accordance with Section 01 78 23 OPERATION AND MAINTENANCE DATA.

1.6.2 Assembled Operation and Maintenance Manuals

Assemble and securely bind manuals in durable, hard covered, water resistant binders. Assemble and index the manuals in the following order with a table of contents:

- a. Manufacturer's O&M information required by the paragraph SD-10, OPERATION AND MAINTENANCE DATA.
- b. Catalog data required by the paragraph SD-03, PRODUCT DATA.
- c. Drawings required by the paragraph SD-02, SHOP DRAWINGS.
- d. Prices for spare parts and supply list.
- e. Information on metering.
- f. Design test reports.
- g. Production test reports.

1.6.3 Spare Parts

Provide spare parts as specified below. Provide spare parts that are of the same material and workmanship, meet the same requirements, and are interchangeable with the corresponding original parts furnished.

1.7 WARRANTY

Provide equipment items that are supported by service organizations reasonably convenient to the equipment installation in order to render satisfactory service to the equipment on a regular and emergency basis during the warranty period of the contract.

PART 2 PRODUCTS

2.1 PRODUCT COORDINATION

Products and materials not considered to be switchboards and related

accessories are specified in Section 33 71 02 UNDERGROUND ELECTRICAL DISTRIBUTION.

2.2 SWITCHBOARD

NEMA PB 2 and UL 891.

2.2.1 Ratings

Provide equipment with the following ratings:

- a. Voltage rating: 480Y/277 or 208Y/120 120 volts AC, three-phase, 4-wire as indicated.
- b. Continuous current rating of the main bus: as indicated.
- c. Short-circuit current rating: as indicated.
- d. UL listed and labeled as service entrance equipment.

2.2.2 Construction

Provide the following:

- a. Switchboard: consisting of one or more vertical sections bolted together to form a rigid assembly and front and rear aligned as indicated.
- b. All circuit breakers: front accessible.
- c. Rear aligned switchboards: front accessible load connections.
- d. Where indicated, "space for future" or "space" means to include a vertical bus provided behind a blank front cover. Where indicated, "provision for future" means full hardware provided to mount a breaker suitable for the location.
- e. Completely factory engineered and assembled, including protective devices and equipment indicated with necessary interconnections, instrumentation, and control wiring.

2.2.2.1 Enclosure

Provide the following:

- a. Enclosure: NEMA ICS 6 Type 3R as indicated fabricated entirely of 12 gauge ASTM A240/A240M type 304 or 304L stainless steel.
- b. Enclosure: bolted together with removable bolt-on side, and sloping roof downward toward rear.
- c. Front doors: provided with stainless steel padlockable vault handles with a three point catch.
- d. Bases, frames and channels of enclosure: corrosion resistant and fabricated of ASTM A240/A240M type 304L stainless steel. Separate sections using vertical steel barriers.
- e. Base: includes any part of enclosure that is within 3 inches of

concrete pad.

- f. Paint color: ASTM D1535 light gray No. 61 or No. 49 over rust inhibitor.
- g. Paint coating system: comply with IEEE C57.12.28 for galvanized steel and IEEE C57.12.29 for stainless steel.

2.2.2.2 Bus Bars

Provide the following:

- a. Bus bars: [copper with silver-plated contact surfaces.
 - (1) Phase bus bars: [uninsulated][insulated with a tape wrap or insulating sleeve providing a minimum breakdown voltage of 16,000 volts per ASTM D149].
 - (2) Neutral bus: rated 100 percent of the main bus continuous current rating[as indicated.
- b. Make bus connections and joints with hardened steel bolts.
- c. Main-bus (through bus): rated at the full ampacity of the main throughout the switchboard.
- d. Minimum one-quarter by 2 inch copper ground bus secured to each vertical section along the entire length of the switchboard.

2.2.2.3 Main Section

Provide the main section consisting of a combination section with molded-case circuit breaker and utility transformer compartment.

2.2.2.4 Distribution Sections

Provide the distribution section[s] consisting of individually mounted, as indicated.

2.2.2.5 Auxiliary Sections

Provide auxiliary sections consisting of indicated metering equipment and transformer, as indicated.

2.2.2.6 Handles

Provide handles for individually mounted devices of the same design and method of external operation. Label handles prominently to indicate device ampere rating, color coded for device type. Identify ON-OFF indication by handle position and by prominent marking.

2.2.3 Protective Device

Provide main and branch protective devices as indicated.

2.2.3.1 Molded-Case Circuit Breaker

Provide the following:

- a. UL 489. UL listed and labeled, low voltage molded-case circuit breaker, with a short-circuit current rating as indicated.

2.2.4 Metering

2.2.4.1 Digital Meters

IEEE C37.90.1 for surge withstand. Provide true rms, plus/minus one percent accuracy, programmable, microprocessor-based meter enclosed in a sealed case with the following features.

- a. Display capability:

- (1) Multi-Function Meter: Display a selected phase to neutral voltage, phase to phase voltage, percent phase to neutral voltage THD, percent phase to phase voltage THD; a selected phase current, neutral current, percent phase current THD, percent neutral current; selected total PF, kW, KVA, kVAR, FREQ, kVAh, kWh. Detected alarm conditions include over/under current, over/under voltage, over/under KVA, over/under frequency, over/under selected PF/kVAR, voltage phase reversal, voltage imbalance, reverse power, over percent THD. Include a Form C KYZ pulse output relay on the meter.

- b. Design meters to accept input from standard 5A secondary instrument transformers and direct voltage monitoring range to 300 volts, phase to phase.

- c. Provide meter that calculates and stores average max/min demand values with time and date for all readings based on a user selectable sliding window averaging period.

2.2.5 Heaters

Provide 120-volt heaters in each switchboard section. Provide heaters of sufficient capacity to control moisture condensation in the section, 250 watts minimum, and controlled by a thermostat and humidistat located in the section. Provide industrial type thermostat, high limit, to maintain sections within the range of 60 to 90 degrees F. Provide humidistat with a range of 30 to 60 percent relative humidity. Obtain supply voltage for the heaters from a control power transformer within the switchboard. If heater voltage is different than switchboard voltage, provide transformer rated to carry 125 percent of heater full load rating. Provide transformer with a 220 degrees C insulation system with a temperature rise not exceeding 115 degrees C and conforming to NEMA ST 20

2.2.6 Terminal Boards

Provide with engraved plastic terminal strips and screw type terminals for external wiring between components and for internal wiring between removable assemblies. Provide short-circuiting type terminal boards associated with current transformer. Terminate conductors for current transformers with ring-tongue lugs. Provide terminal board identification that is identical in similar units. Provide color coded external wiring that is color coded consistently for similar terminal boards.

2.2.7 Wire Marking

Mark control and metering conductors at each end. Provide factory

installed, white, plastic tubing, heat stamped with black block type letters on factory-installed wiring. On field-installed wiring, provide white, preprinted, polyvinyl chloride (PVC) sleeves, heat stamped with black block type letters. Provide a single letter or number on each sleeve, elliptically shaped to securely grip the wire, and keyed in such a manner to ensure alignment with adjacent sleeves. Provide specific wire markings using the appropriate combination of individual sleeves. Indicate on each wire marker the device or equipment, including specific terminal number to which the remote end of the wire is attached.

2.3 MANUFACTURER'S NAMEPLATE

Provide a nameplate on each item of equipment bearing the manufacturer's name, address, model number, and serial number securely affixed in a conspicuous place; the nameplate of the distributing agent is not acceptable. This nameplate and method of attachment may be the manufacturer's standard if it contains the required information.

2.4 FIELD FABRICATED NAMEPLATES

ASTM D709. Provide laminated plastic nameplates for each switchboard, equipment enclosure, relay, switch, and device; as specified in this section or as indicated on the drawings. Identify on each nameplate inscription the function and, when applicable, the position. Provide nameplates of melamine plastic, 0.125 inch thick, white with black center core. Provide matte finish surface. Provide square corners. Accurately align lettering and engrave into the core. Provide nameplates with minimum size of one by 2.5 inches. Provide lettering that is a minimum of 0.25 inch high normal block style.

2.5 SOURCE QUALITY CONTROL

2.5.1 Switchboard Design Tests

NEMA PB 2 and UL 891.

2.5.1.1 Design Tests

Furnish documentation showing the results of design tests on a product of the same series and rating as that provided by this specification.

- a. Short-circuit current test.
- b. Enclosure tests.
- c. Dielectric test.

2.5.1.2 Additional Design Tests

In addition to normal design tests, perform the following tests on the actual equipment. Furnish reports which include results of design tests performed on the actual equipment.

- a. Temperature rise tests.
- b. Continuous current.

2.5.2 Switchboard Production Tests

NEMA PB 2 and UL 891. Furnish reports which include results of production tests performed on the actual equipment for this project. These tests include:

- a. 60-hertz dielectric tests.
- b. Mechanical operation tests.
- c. Electrical operation and control wiring tests.
- d. Ground fault sensing equipment test.

2.6 ARC FLASH WARNING LABEL

Provide warning label for switchboards. Locate this self-adhesive warning label on the outside of the enclosure warning of potential electrical arc flash hazards and appropriate PPE required. Provide label format as indicated.

2.7 SERVICE ENTRANCE AVAILABLE FAULT CURRENT LABEL

Provide label on exterior of switchboards used as service equipment listing the maximum available fault current at that location. Include on the label the date that the fault calculation was performed and the contact information for the organization that completed the calculation. Locate this self-adhesive warning label on the outside of the switchboard. Provide label format as indicated.

PART 3 EXECUTION

3.1 INSTALLATION

Conform to IEEE C2, NFPA 70, and to the requirements specified herein. Provide new equipment and materials unless indicated or specified otherwise.

3.2 GROUNDING

NFPA 70 and IEEE C2, except that grounds and grounding systems with a resistance to solid earth ground not exceeding 25 ohms.

3.2.1 Grounding Electrodes

Provide driven ground rods as specified in Section 33 71 02 UNDERGROUND ELECTRICAL DISTRIBUTION. Connect ground conductors to the upper end of the ground rods by exothermic weld or compression connector. Provide compression connectors at equipment end of ground conductors.

3.2.2 Equipment Grounding

Provide bare copper cable not smaller than No. 4/0 AWG not less than 24 inches below grade connecting to the indicated ground rods. When work in addition to that indicated or specified is directed to obtain the specified ground resistance, the provision of the contract covering "Changes" applies.

3.2.3 Connections

Make joints in grounding conductors and loops by exothermic weld or compression connector. Install exothermic welds and compression connectors as specified in Section 33 71 02 UNDERGROUND ELECTRICAL DISTRIBUTION.

3.2.4 Grounding and Bonding Equipment

UL 467, except as indicated or specified otherwise.

3.3 INSTALLATION OF EQUIPMENT AND ASSEMBLIES

Install and connect equipment furnished under this section as indicated on project drawings, the approved shop drawings, and as specified herein.

3.3.1 Switchboard

ANSI/NEMA PB 2.1.

3.3.2 Meters and Instrument Transformers

ANSI C12.1.

3.3.3 Field Applied Painting

Where field painting of enclosures is required to correct damage to the manufacturer's factory applied coatings, provide manufacturer's recommended coatings and apply in accordance with manufacturer's instructions.

3.3.4 Galvanizing Repair

Repair damage to galvanized coatings using ASTM A780/A780M, zinc rich paint, for galvanizing damaged by handling, transporting, cutting, welding, or bolting. Do not heat surfaces that repair paint has been applied to.

3.3.5 Field Fabricated Nameplate Mounting

Provide number, location, and letter designation of nameplates as indicated. Fasten nameplates to the device with a minimum of two sheet-metal screws or two rivets.

3.4 FOUNDATION FOR EQUIPMENT AND ASSEMBLIES

3.4.1 Exterior Location

Mount switchboard on concrete slab as follows:

- a. Unless otherwise indicated, provide the slab with dimensions at least 8 inches thick, reinforced with a 6 by 6 inch No. 6 mesh placed uniformly 4 inches from the top of the slab.
- b. Place slab on a 6 inch thick, well-compacted gravel base.
- c. Install slab such that the top of the concrete slab is approximately 4 inches above the finished grade.

- d. Provide edges above grade 1/2 inch chamfer.
- e. Provide slab of adequate size to project at least 8 inches beyond the equipment.
- f. Provide conduit turnups and cable entrance space required by the equipment to be mounted.
- g. Seal voids around conduit openings in slab with water- and oil-resistant caulking or sealant.
- h. Cut off and bush conduits 3 inches above slab surface.
- i. Provide concrete work as specified in Section 03 30 00 CAST-IN-PLACE CONCRETE.

3.4.2 Interior Location

Mount switchboard on concrete slab as follows:

- a. Unless otherwise indicated, provide the slab with dimensions at least 4 inches thick.
- b. Install slab such that the top of the concrete slab is approximately 4 inches above the finished grade.
- c. Provide edges above grade 1/2 inch chamfer.
- d. Provide slab of adequate size to project at least 8 inches beyond the equipment.
- e. Provide conduit turnups and cable entrance space required by the equipment to be mounted.
- f. Seal voids around conduit openings in slab with water- and oil-resistant caulking or sealant.
- g. Cut off and bush conduits 3 inches above slab surface.
- h. Provide concrete work as specified in Section 03 30 00 CAST-IN-PLACE CONCRETE.

3.5 FIELD QUALITY CONTROL

Submit Required Settings of breakers to the Contracting Officer after approval of switchboard and at least 30 days in advance of their requirement.

3.5.1 Performance of Acceptance Checks and Tests

Perform in accordance with the manufacturer's recommendations and include the following visual and mechanical inspections and electrical tests, performed in accordance with NETA ATS.

3.5.1.1 Switchboard Assemblies

- a. Visual and Mechanical Inspection

(1) Compare equipment nameplate data with specifications and approved

shop drawings.

- (2) Inspect physical, electrical, and mechanical condition.
- (3) Verify appropriate anchorage, required area clearances, and correct alignment.
- (4) Clean switchboard and verify shipping bracing, loose parts, and documentation shipped inside cubicles have been removed.
- (5) Inspect all doors, panels, and sections for paint, dents, scratches, fit, and missing hardware.
- (6) Verify that fuse and circuit breaker sizes and types correspond to approved shop drawings as well as to the circuit breaker's address for microprocessor-communication packages.
- (7) Verify that current transformer ratios correspond to approved shop drawings.
- (8) Inspect all bolted electrical connections for high resistance using low-resistance ohmmeter, verifying tightness of accessible bolted electrical connections by calibrated torque-wrench method, or performing thermographic survey.
- (9) Confirm correct operation and sequencing of electrical and mechanical interlock systems.
- (10) Confirm correct application of manufacturer's recommended lubricants.
- (11) Inspect insulators for evidence of physical damage or contaminated surfaces.
- (12) Verify correct barrier installation and operation.
- (13) Exercise all active components.
- (14) Inspect all mechanical indicating devices for correct operation.
- (15) Verify that filters are in place and vents are clear.
- (16) Test operation, alignment, and penetration of instrument transformer withdrawal disconnects.
- (17) Inspect control power transformers.

b. Electrical Tests

- (1) Perform insulation-resistance tests on each bus section.
- (2) Perform dielectric withstand voltage tests.
- (3) Perform insulation-resistance test on control wiring; Do not perform this test on wiring connected to solid-state components.
- (4) Perform control wiring performance test.
- (5) Perform primary current injection tests on the entire current

circuit in each section of assembly.

- (6) Perform phasing check on double-ended switchboard to ensure correct bus phasing from each source.
- (7) Verify operation of switchboard heaters.

3.5.1.2 Circuit Breakers

Low Voltage Molded Case

a. Visual and Mechanical Inspection

- (1) Compare nameplate data with specifications and approved shop drawings.
- (2) Inspect circuit breaker for correct mounting.
- (3) Operate circuit breaker to ensure smooth operation.
- (4) Inspect case for cracks or other defects.
- (5) Inspect all bolted electrical connections for high resistance using low resistance ohmmeter, verifying tightness of accessible bolted connections and/or cable connections by calibrated torque-wrench method, or performing thermographic survey.
- (6) Inspect mechanism contacts and arc chutes in unsealed units.

b. Electrical Tests

- (1) Perform contact-resistance tests.
- (2) Perform insulation-resistance tests.
- (3) Perform Breaker adjustments for final settings in accordance with Government provided settings.
- (4) Perform long-time delay time-current characteristic tests
- (5) Determine short-time pickup and delay by primary current injection.
- (6) Determine ground-fault pickup and time delay by primary current injection.
- (7) Determine instantaneous pickup current by primary injection.
- (8) Verify correct operation of any auxiliary features such as trip and pickup indicators, zone interlocking, electrical close and trip operation, trip-free, and anti-pump function.

3.5.1.3 Current Transformers

a. Visual and Mechanical Inspection

- (1) Compare equipment nameplate data with specifications and approved shop drawings.
- (2) Inspect physical and mechanical condition.

- (3) Verify correct connection.
- (4) Verify that adequate clearances exist between primary and secondary circuit.
- (5) Inspect all bolted electrical connections for high resistance using low-resistance ohmmeter, verifying tightness of accessible bolted electrical connections by calibrated torque-wrench method, or performing thermographic survey.
- (6) Verify that all required grounding and shorting connections provide good contact.

b. Electrical Tests

- (1) Perform resistance measurements through all bolted connections with low-resistance ohmmeter, if applicable.
- (2) Perform insulation-resistance tests.
- (3) Perform polarity tests.
- (4) Perform ratio-verification tests.

3.5.1.4 Metering and Instrumentation

a. Visual and Mechanical Inspection

- (1) Compare equipment nameplate data with specifications and approved shop drawings.
- (2) Inspect physical and mechanical condition.
- (3) Verify tightness of electrical connections.

b. Electrical Tests

- (1) Determine accuracy of meters at 25, 50, 75, and 100 percent of full scale.
- (2) Calibrate watthour meters according to manufacturer's published data.
- (3) Verify all instrument multipliers.
- (4) Electrically confirm that current transformer and voltage transformer secondary circuits are intact.

3.5.1.5 Grounding System

a. Visual and Mechanical Inspection

- (1) Inspect ground system for compliance with contract plans and specifications.

b. Electrical Tests

- (1) IEEE 81. Perform ground-impedance measurements utilizing the

fall-of-potential method. On systems consisting of interconnected ground rods, perform tests after interconnections are complete. On systems consisting of a single ground rod perform tests before any wire is connected. Take measurements in normally dry weather, not less than 48 hours after rainfall. Use a portable ground resistance tester in accordance with manufacturer's instructions to test each ground or group of grounds. Use an instrument equipped with a meter reading directly in ohms or fractions thereof to indicate the ground value of the ground rod or grounding systems under test.

- (2) Submit the measured ground resistance of each ground rod and grounding system, indicating the location of the rod and grounding system. Include the test method and test setup (i.e., pin location) used to determine ground resistance and soil conditions at the time the measurements were made.

3.5.2 Follow-Up Verification

Upon completion of acceptance checks, settings, and tests, show by demonstration in service that circuits and devices are in good operating condition and properly performing the intended function. Trip circuit breakers by operation of each protective device. Test each item to perform its function not less than three times. As an exception to requirements stated elsewhere in the contract, provide the Contracting Officer five working days advance notice of the dates and times for checks, settings, and tests.

-- End of Section --

SECTION 26 32 15

ENGINE-GENERATOR SET STATIONARY 15-2500 KW, WITH AUXILIARIES

PART 1 GENERAL

1.1 REFERENCES

The publications listed below form a part of this specification to the extent referenced. The publications are referred to within the text by the basic designation only.

AMERICAN SOCIETY OF MECHANICAL ENGINEERS (ASME)

ASME B16.3	(2016) Malleable Iron Threaded Fittings, Classes 150 and 300
ASME B16.5	(2020) Pipe Flanges and Flanged Fittings NPS 1/2 Through NPS 24 Metric/Inch Standard
ASME B16.11	(2016) Forged Fittings, Socket-Welding and Threaded
ASME B16.21	(2016) Nonmetallic Flat Gaskets for Pipe Flanges

ASTM INTERNATIONAL (ASTM)

ASTM A53/A53M	(2020) Standard Specification for Pipe, Steel, Black and Hot-Dipped, Zinc-Coated, Welded and Seamless
ASTM A106/A106M	(2019a) Standard Specification for Seamless Carbon Steel Pipe for High-Temperature Service
ASTM A181/A181M	(2014; R 2020) Standard Specification for Carbon Steel Forgings, for General-Purpose Piping
ASTM A193/A193M	(2020) Standard Specification for Alloy-Steel and Stainless Steel Bolting Materials for High-Temperature Service and Other Special Purpose Applications
ASTM A194/A194M	(2020a) Standard Specification for Carbon Steel, Alloy Steel, and Stainless Steel Nuts for Bolts for High-Pressure or High-Temperature Service, or Both
ASTM A234/A234M	(2019) Standard Specification for Piping Fittings of Wrought Carbon Steel and Alloy Steel for Moderate and High Temperature Service
ASTM B395/B395M	(2018) Standard Specification for U-Bend

Seamless Copper and Copper Alloy Heat
Exchanger and Condenser Tubes

ASTM D975 (2020) Standard Specification for Diesel
Fuel Oils

ELECTRICAL GENERATING SYSTEMS ASSOCIATION (EGSA)

EGSA 101P (1995) Performance Standard for Engine
Driven Generator Sets

INSTITUTE OF ELECTRICAL AND ELECTRONICS ENGINEERS (IEEE)

IEEE 1 (2000; R 2011) General Principles for
Temperature Limits in the Rating of
Electric Equipment and for the Evaluation
of Electrical Insulation

IEEE 43 (2013) Recommended Practice for Testing
Insulation Resistance of Rotating Machinery

IEEE 81 (2012) Guide for Measuring Earth
Resistivity, Ground Impedance, and Earth
Surface Potentials of a Ground System

IEEE 100 (2000; Archived) The Authoritative
Dictionary of IEEE Standards Terms

IEEE 115 (2019) Guide for Test Procedures for
Synchronous Machines: Part I Acceptance
and Performance Testing; Part II Test
Procedures and Parameter Determination for
Dynamic Analysis

IEEE 120 (1989; R 2007) Master Test Guide for
Electrical Measurements in Power Circuits

IEEE 519 (2014) Recommended Practices and
Requirements for Harmonic Control in
Electrical Power Systems

IEEE C2 (2017; Errata 1-2 2017; INT 1 2017)
National Electrical Safety Code

IEEE C57.13 (2016) Requirements for Instrument
Transformers

INTERNATIONAL CODE COUNCIL (ICC)

ICC IBC (2021) International Building Code

INTERNATIONAL ELECTRICAL TESTING ASSOCIATION (NETA)

NETA ATS (2021) Standard for Acceptance Testing
Specifications for Electrical Power
Equipment and Systems

INTERNATIONAL ELECTROTECHNICAL COMMISSION (IEC)

IEC 60034-2A (1974; ED 1.0) Rotating Electrical
Machines Part 2: Methods for Determining
Losses and Efficiency of Rotating
Electrical Machinery from Tests (Excluding
Machines for Traction Vehicles)
Measurement of Losses by the Calorimetric
Method

INTERNATIONAL ORGANIZATION FOR STANDARDIZATION (ISO)

ISO 3046 (2002, 2006, 2009, 2001) Reciprocating
Internal Combustion Engines -
Performance--Part 1, 3, 4, 5, 6

ISO 8528 (1993; R 2018) Reciprocating Internal
Combustion Engine Driven Alternating
Current Generator Sets--Part 1, 2, 3, 4,
5, 6, 7, 8, 9, 10, 12, 13

NATIONAL ELECTRICAL MANUFACTURERS ASSOCIATION (NEMA)

NEMA ICS 6 (1993; R 2016) Industrial Control and
Systems: Enclosures

NEMA MG 1 (2018) Motors and Generators

NEMA PB 2 (2011) Deadfront Distribution Switchboards

NATIONAL FIRE PROTECTION ASSOCIATION (NFPA)

NFPA 30 (2021; TIA 20-1; TIA 20-2) Flammable and
Combustible Liquids Code

NFPA 37 (2021) Standard for the Installation and
Use of Stationary Combustion Engines and
Gas Turbines

NFPA 54 (2021) National Fuel Gas Code

NFPA 70 (2020; ERTA 20-1 2020; ERTA 20-2 2020; TIA
20-1; TIA 20-2; TIA 20-3; TIA 20-4)
National Electrical Code

NFPA 110 (2016) Standard for Emergency and Standby
Power Systems

SOCIETY OF AUTOMOTIVE ENGINEERS INTERNATIONAL (SAE)

SAE ARP892 (1965; R 1994) DC Starter-Generator, Engine

SAE J537 (2016) Storage Batteries

U.S. NATIONAL ARCHIVES AND RECORDS ADMINISTRATION (NARA)

40 CFR 60 Standards of Performance for New
Stationary Sources

UNDERWRITERS LABORATORIES (UL)

UL 142	(2006; Reprint Jan 2021) UL Standard for Safety Steel Aboveground Tanks for Flammable and Combustible Liquids
UL 467	(2013; Reprint Jun 2017) UL Standard for Safety Grounding and Bonding Equipment
UL 489	(2016; Rev 2019) UL Standard for Safety Molded-Case Circuit Breakers, Molded-Case Switches and Circuit-Breaker Enclosures
UL 891	(2005; Reprint Oct 2012) Switchboards
UL 1236	(2015; Reprint Feb 2021) UL Standard for Safety Battery Chargers for Charging Engine-Starter Batteries

1.2 RELATED MATERIALS

Section 33 71 02 UNDERGROUND ELECTRICAL DISTRIBUTION apply to this section, except as modified herein.

1.3 SUBMITTALS

Government approval is required for submittals with a "G" classification. Submittals not having a "G" classification are for information only. When used, a code following the "G" classification identifies the office that will review the submittal for the Government. Submit the following in accordance with Section 01 33 00 SUBMITTAL PROCEDURES:

SD-02 Shop Drawings

Engine-Generator Set and Auxiliary Equipment

Auxiliary Systems Engine-Generator Set and Auxillary Equipment Drawing Requirements

Auxiliary Systems Drawing Requirements Acceptance

SD-03 Product Data

Harmonic Requirements

Engine-Generator Set Efficiencies

Emissions

Filters

Special tools

Remote Alarm Annunciator

Engine-Generator Parameter Schedule

Heat Exchanger

Generator
Manufacturer's Catalog
Site Welding
Spare Parts
Onsite Training
Vibration-Isolation
Posted Data and Instructions
Instructions
Experience
Field Engineer
General Installation
Exciter

SD-05 Design Data

Performance Criteria
Sound Limitations
Integral Main Fuel Storage Tank
Power Factor
Heat Exchanger
Time-Delay on Alarms
Cooling System
Vibration Isolation
Battery Charger
Capacity Calculations for Engine-Generator Set
Brake Mean Effective Pressure (BMEP) Calculations
Torsional Vibration Stress Analysis Computations
Capacity Calculations for Batteries
Turbocharger Load Calculations

SD-06 Test Reports

Performance Tests
Factory Inspection and Tests

Factory Tests

Onsite Inspection and Tests

Acceptance Checks and Tests

Functional Acceptance Tests

Maintenance Procedures

Operation and Maintenance Manuals

Inspections

Functional Acceptance Test Procedure

SD-07 Certificates

Cooling System

Vibration Isolation

Prototype Test

Reliability and Durability

Fuel System Certification

Start-Up Engineer

Instructor's Qualification Resume

Engine Emission Limits

Sound Limitations

Site Visit

Current Balance

Materials and Equipment

Factory Inspection and Tests

SD-09 Manufacturer's Field Reports

Engine Tests

Generator Tests

Assembled Engine-Generator Set Tests

SD-10 Operation and Maintenance Data

Preliminary Assembled Operation and Maintenance Manuals

SD-11 Closeout Submittals

Posted Data and Instructions

Training Plan

1.4 QUALITY ASSURANCE

1.4.1 Conformance to Codes and Standards

Where equipment is specified to conform to requirements of any code or standard such as UL, NEMA, etc., the design, fabrication and installation must also conform to the code.

1.4.2 Vibration Limitation

Limit the maximum engine-generator set vibration in the horizontal, vertical, and axial directions to 6 mils (peak-peak RMS), with an overall velocity limit of 0.95 inches/second RMS, at rated speed for all loads through 110 percent of rated speed. The engine-generator set must be provided with vibration isolation in accordance with the manufacturer's standard recommendation. Where the vibration isolation system does not secure the base to the structure floor or unit foundation, provide seismic restraints in accordance with the seismic parameters specified.

1.4.3 Torsional Analysis

Submit torsional analysis including prototype testing or calculations which certify and demonstrate that no damaging or dangerous torsional vibrations will occur when the prime mover is connected to the generator, at synchronous speeds, plus/minus 10 percent.

1.4.4 Performance Data

Submit vibration isolation system performance data for the range of frequencies generated by the engine-generator set during operation from no load to full load and the maximum vibration transmitted to the floor. Also submit a description of seismic qualification of the engine-generator mounting, base, and vibration isolation.

1.4.5 Seismic Requirements

Seismic requirements must be in accordance with 26 05 48 SEISMIC PROTECTION FOR ELECTRICAL EQUIPMENT as shown on the drawings.

1.4.6 Experience

Each component manufacturer must have a minimum of 3 years' experience in the manufacture, assembly and sale of components used with stationary engine-generator sets for commercial and industrial use. The engine-generator set manufacturer/assembler must have a minimum of 3 years' experience in the manufacture, assembly and sale of stationary engine-generator sets for commercial and industrial use. Submit a statement showing and verifying these requirements.

1.4.7 Field Engineer

The engine-generator set manufacturer or assembler must furnish a qualified field engineer to supervise the complete installation of the engine-generator set, assist in the performance of the onsite tests, and instruct personnel as to the operational and maintenance features of the

equipment. The field engineer must have attended the engine generator manufacturer's training courses on installation and operation and maintenance of engine generator sets. Submit a letter listing the qualifications, schools, formal training, and experience of the field engineer.

1.4.8 Detailed Drawings

Submit detailed drawings showing the following:

- a. Base-mounted equipment, complete with base and attachments, including anchor bolt template and recommended clearances for maintenance and operation.
- b. Starting system.
- c. Fuel system.
- d. Cooling system.
- e. Exhaust system.
- f. Electric wiring of relays, breakers, programmable controllers, and switches including single line and wiring diagrams.
- g. Lubrication system, including piping, pumps, strainers, filters, [heat exchangers for lube oil and turbocharger cooling,] [electric heater,] controls and wiring.
- h. Location, type, and description of vibration isolation devices for all applications.
- i. The safety system, including wiring schematics.
- j. One-line schematic and wiring diagrams of the generator, exciter, regulator, governor, and instrumentation.
- k. Panel layouts.
- l. Mounting and support for each panel and major piece of electrical equipment.
- m. Engine-generator set rigging points and lifting instructions.

1.4.9 Auxiliary Systems Engine-Generator Set and Auxiliary Equipment Drawing Requirements

Submit drawings pertaining to the engine-generator set and auxiliary equipment, including but not limited to the following:

- a. Certified outline, general arrangement (setting plan), and anchor bolt details. Show total weight and center of gravity of assembled equipment on the steel sub-base.
- b. Detailed elementary, schematic wiring, and interconnection diagrams of the engine starting system, jacket coolant heating system, engine protective devices, engine alarm devices, engine speed governor system, generator and excitation system, and other integral devices.

- c. Detailed elementary, schematic wiring; and interconnection diagrams of the fuel system, starting battery system, engine-generator control panel, generator circuit breaker, and remote alarm annunciator.
- d. Dimensional drawings or catalog cuts of exhaust silencers, radiator, fuel day tanks, fuel oil cooler, valves and pumps, intake filters, vibration isolators, and other auxiliary equipment not integral with the engine-generator set.

1.4.10 Auxiliary Systems Drawing Requirements

Submit drawings showing floor plan arrangement of exhaust, air intake, fuel oil cooler, and jacket coolant water systems including arrangement of piping and pipe sizes.

1.4.11 Vibration Isolation System Certification

Submit certification from the manufacturer that the vibration isolation system will reduce the vibration to the limits specified in the paragraph VIBRATION ISOLATION.

1.4.12 Fuel System Certification

When the fuel system requires a fuel oil cooler as described in the paragraph FUEL OIL COOLER, submit certification from the engine manufacturer that the fuel system design is satisfactory.

1.5 DELIVERY, STORAGE, AND HANDLING

Properly protect materials and equipment, in accordance with the manufacturers recommended storage procedures, before, during, and after installation. Protect stored items from the weather and contamination. During installation, cap piping and similar openings to keep out dirt and other foreign matter.

Deliver equipment on pallets or blocking wrapped in heavy-duty plastic, sealed to protect parts and assemblies from moisture and dirt. Protect and prepare batteries for shipment as recommended by the battery manufacturer. Store auxiliary equipment at the site in covered enclosures, protected from atmospheric moisture, dirt, and ground water.

1.6 EXTRA MATERIALS

Provide two sets of special tools and two sets of filters required for maintenance. Special tools are those that only the manufacturer provides, for special purposes, or to reach otherwise inaccessible parts. One handset must be provided for each electronic governor when required to indicate and/or change governor response settings. Furnish 4 liters one gallon of identical paint used on engine-generator set in manufacturer's sealed container with each engine-generator set.

Wrenches and tools specifically designed and required to work on the new equipment, which are not commercially available as standard mechanic's tools, must be furnished to the Contracting Officer.

Provide proposed operating instructions for the engine-generator set and auxiliary equipment laminated between matte-surface thermoplastic sheets and suitable for placement adjacent to corresponding equipment. After approval, install operating instructions where directed.

1.7 MAINTENANCE SERVICES

Submit the operation and maintenance manuals and have them approved prior to commencing onsite tests.

1.7.1 Operation Manual

Provide three copies of the operation manual in 8-1/2 by 11 inch three-ring binders. Sections must be separated by heavy plastic dividers with tabs which identify the material in the section. Fold drawings with the title block visible, and placed in 8-1/2 by 11 inch plastic pockets with reinforced holes. The manual must include:

- a. Step-by-step procedures for system startup, operation, and shutdown;
- b. Drawings, diagrams, and single-line schematics to illustrate and define the electrical, mechanical, and hydraulic systems with their controls, alarms, and safety systems;
- c. Procedures for interface and interaction with related systems to include [automatic transfer switches] [fire alarm/suppression systems] [load shedding systems] [uninterruptible power supplies] [_____].

1.7.2 Maintenance Manual

Provide three copies of the maintenance manual containing the information described below in 8-1/2 x 11 inch three-ring binders. Separate each section by a heavy plastic divider with tabs. Fold drawings with the title block visible, and placed in plastic pockets with reinforced holes. The manual must include:

- a. Procedures for each routine maintenance item. Procedures for troubleshooting. Factory-service, take-down overhaul, and repair service manuals, with parts lists.
- b. The manufacturer's recommended maintenance schedule.
- c. A component list which includes the manufacturer's name, address, type or style, model or serial number, rating, and catalog number for the major components.
- d. A list of spare parts for each piece of equipment and a complete list of materials and supplies needed for operation.

1.7.3 Assembled Operation and Maintenance Manuals

The contents of the assembled operation and maintenance manuals must include the manufacturer's O&M information required by the paragraph SD-10, OPERATION AND MAINTENANCE DATA and the manufacturer's O&M information specified in Section 26 36 23 AUTOMATIC TRANSFER SWITCHES AND BY-PASS/ISOLATION SWITCH.

- a. Manuals must be in separate books or volumes, assembled and bound securely in durable, hard covered, water resistant binder, and indexed by major assembly and components in sequential order.
- b. A table of contents (index) must be made part of the assembled O&M. The manual must be assembled in the order noted in table of contents.

- c. The cover sheet or binder on each volume of the manuals must be identified and marked with the words, "Operation and Maintenance Manual."

1.8 SITE CONDITIONS

Protect the components of the engine-generator set, including cooling system components, pumps, fans, and similar auxiliaries when not operating and provide components capable of the specified outputs in the following environment:

- a. Site Location: State of Hawaii (Oahu and Hawaii Island)
- b. Site Elevation: 15 feet above mean sea level.
- c. Ambient Temperatures:
 - (1) Maximum 120 degrees F dry bulb.
 - (2) Minimum 32 degrees F dry bulb.
- d. Seismic Zone: Category IV as defined by ICC IBC.

PART 2 PRODUCTS

2.1 SYSTEM REQUIREMENTS

- a. Provide and install each engine-generator set complete and totally functional, with all necessary ancillary equipment to include: air filtration; starting system; generator controls, protection, and isolation; instrumentation; lubrication; fuel system; cooling system; and engine exhaust system. Each engine-generator set must satisfy the requirements specified in the Engine-Generator Parameter Schedule. Submit certification that the engine-generator set and cooling system function properly in the ambient temperatures specified.
- b. Provide each engine-generator set consisting of one engine, one generator, and one exciter mounted, assembled, and aligned on one base; and all other necessary ancillary equipment which may be mounted separately. Assemble sets having a capacity of 750 kW or smaller and attach to the base prior to shipping. Sets over 750 kW capacity may be shipped in sections. Provide set components that are environmentally suitable for the locations shown and that are the manufacturer's standard product offered in catalogs for commercial or industrial use. Provide a generator strip heater for moisture control when the generator is not operating. Identify any nonstandard products or components and the reason for their use.

2.1.1 Engine-Generator Parameter Schedule

Engine-Generator Set and Auxiliary Equipment Capacity Calculations for Engine-Generator Set

ENGINE-GENERATOR PARAMETER SCHEDULE	
Identification	Make/Model
Electrical Characteristics	
Power Rating	Emergency Standby Gross bhp rating / Net brake power rating [_____] kW at 0.8 power factor
Governor Type	Type Make / Model Isochronous
Overload Capacity (Prime applications only)	110 percent of Service Load for 1 hour in 12 consecutive hours
Service Load	[_____] kVA (continuous)
Motor Starting kVA (Max.)	[_____] kVA
Power Factor	0.8 lagging
Voltage Regulation (No Load to Full Load)(Stand-alone applications)	plus or minus 2 percent (maximum)
Voltage Bandwidth (steady state)	plus or minus 0.5 percent
Frequency	60 Hz
Voltage	[_____] volts
Phases	3 Phase, Wye
Minimum Generator Sub-transient Reactance	20 percent Sub-transient
Nonlinear Loads	25 kVA
Max Step Load Increase	75 percent of Service Load at 0.8 PF
Transient Recovery Time with Step Load Increase (Voltage)	3 seconds
Transient Recovery	3 seconds
Time with Step Load Increase (Frequency)	
Maximum Voltage Deviation with Step Load Increase	10 percent of rated voltage

ENGINE-GENERATOR PARAMETER SCHEDULE	
Maximum Frequency Deviation with Step Load Increase	2.5 percent of rated frequency
Max Step Load Decrease (without shutdown)	50 percent of Service Load at 0.8 PF
Frequency Bandwidth (steady state)	plus or minus 0.25 percent
Frequency Regulation (droop) (No Load to Full Load)	0.25 percent (maximum)
Frequency Bandwidth (steady state)	plus or minus 0.25 percent
Reactances	Synchronous reactance, Xd Transient reactance, X'd Sub-transient reactance, X"d Negative sequence reactance, X2 Zero sequence reactance, Xo
Capacity Calculations	
Calculations must verify that the engine-generator set power rating is adequate for the following load conditions:	
Lighting	25 kW
Computer	5 kW
Uninterruptible Power Supplies (UPS)	10 kVA
Variable Frequency Drives (VFD)	25 kVA
Capacity Calculations for Batteries	
Calculation must verify that the engine starting battery capacity exceeds dc power requirements.	
Mechanical Characteristics	
Engine Description	Strokes/cycle Number of cylinders Bore and Stroke, inches
Engine Speed	1800 rpm
Piston Speed	[_____] fpm
Heat Exchanger Type	fin-tube (radiator)
Engine Cooling Type	water/ethylene glycol

ENGINE-GENERATOR PARAMETER SCHEDULE	
Intercooler Type	Air-to-Air / Jacket Water
Induction Method	Turbocharged
Turbocharger	Make / Model
Max Time to Start and be Ready to Assume Load	10 seconds
Max Summer Indoor Temp (Prior to Engine-generator Operation)	120 degrees F
Min Winter Indoor Temp (Prior to Engine-generator Operation)	85 degrees F
Max Allowable Heat Transferred To Engine Generator Space at Rated Output Capacity	80 MBTU/hr
Max Summer Outdoor Temp (Ambient)	120 degrees F
Min Winter Outdoor Temp (Ambient)	80 degrees F
Installation Elevation	15 above sea level
Engine-Generator Set Efficiencies	
Fuel Consumption	At 0.8 power factor, Gallons / hour for: 1 / 2 load 3 / 4 load Full Load
Generator Efficiency	At 0.8 power factor, (percent) hour for: 1 / 2 load 3 / 4 load Full Load
Radiator Capacity	Coolant Type gpm coolant cfm air through radiator Btu per hr of heat exchange based on optimum coolant temperature to and from engine
Engine-Generator Set Emissions Data	
Exhaust Temperature	Degrees F at full load
Weight of Exhaust Gas	lb per hr at full load
Weight of Intake Air	lb per hr at full load

ENGINE-GENERATOR PARAMETER SCHEDULE	
Total Heat Rejected	Btu per hr, at full load to: Jacket Coolant System Fuel Oil Cooling System
Emissions	lb per hr, at full load Total Suspended Particulate Particulate Matter with an average aerodynamic diameter of 10 microns Sulfur Dioxides Nitrogen Oxides (as NO2) Carbon Monoxide Volatile Organic Compounds
Visible Emissions	Percent opacity at full load: 0.3 percent
Brake Mean Effective Pressure (BMEP) Calculations	
<p>Calculation must verify that the engine meets the specified maximum BMEP, as follows:</p> $\text{BMEP psi} = (120,000 \times \text{bkW}) \times (792,000 \times \text{bhp}) / (\text{rpm} \times \text{cu. in.})$ <p>Where:</p> <p>bkW bhp = bkW' + bkW" bhp' + bhp" bkW" bhp" is the Brake kW horsepower required by engine driven fan for cooling radiator or motor driven fan for cooling radiator. bkW' bhp' = kW/GEN.EFF. kW/(GEN.EFF. times 0.746) GEN.EFF. = Generator efficiency cu. in. = Total engine piston displacement in cubic inches rpm = Engine revolutions per minute kW = Minimum power rating</p>	
Torsional Vibration Stress Analysis Computations	

ENGINE-GENERATOR PARAMETER SCHEDULE

Torsional vibrational stresses in the crankshaft and generator shaft of assembled engine and driven generator must not exceed 5000 psi when engine is driving generator at rated speed while assembled unit is loaded to rated engine-generator set power. Computations must be based on a mathematical model of the assembled generator set provided or based on calculations using measured values from tests on a unit identical to the one provided. Calculations based on models of, or measured data from, the unassembled engine and generator will not be acceptable. Calculations must include:

- a. A description of the system relating information pertinent to analysis such as operating speed range and identification plate data.
- b. A mass elastic assembly drawing, showing the arrangement of the units in the generator set and dimensions of shafting, including minimum diameters (or section moduli) of shafting in the system.
- c. A labeled line diagram of the mass elastic system indicating values of masses, stiffness, equivalent lengths, and equivalent diameters including basic assumptions and definition of terms.
- d. Sample computations showing procedures used to obtain resulting stress values.
- e. Computations indicating assembled engine-generator speed of 1800 rpm with assembly loaded to rated generator power and the resulting computed critical torsional stress values in the assembled engine crankshaft and generator shaft.

Turbocharger Load Calculations

NOTE: When the engine-generator set installation includes field installed exhaust system (i.e., the engine-generator set is installed internal to a building in lieu of in a self-contained outdoor enclosure), include the following paragraph.

When the proposed exhaust system layout is different from that shown on the contract drawings, submit calculations showing that the external loads from the exhaust system such as weight and thermal expansion do not exceed the engine manufacturer's maximum allowed forces and moments on the turbocharger.

2.1.2 Rated Output Capacity

Provide each engine-generator-set with power equal to the sum of service load plus the machine's efficiency loss and associated ancillary equipment loads. Rated output capacity must also consider engine and/or generator

oversizing required to meet requirements in paragraph Engine-Generator Parameter Schedule.

The engine must meet the specified maximum BMEP requirements at rated speed as calculated in accordance with the calculations in the engine-generator parameter schedule. The engine capacity must be based on the following:

- a. Engine burning diesel fuel conforming to ASTM D975, Grade 2-D, at an ambient temperature of 85 degrees F. For stationary engines operated in the United States, diesel fuel requirements are found in 40 CFR 60 Subpart IIII.
- b. Engine cooled by a radiator fan mechanically driven by the engine or remote with a motor driven fan.
- c. Engine cooled by coolant mixture of water and ethylene glycol, 50 percent by volume of each.

Maximum BMEP, psi	
	Turbocharged
Four-cycle engines	
Engine speed, rpm:	1800

2.1.2.1 Engine Emission Limits

Engine must be certified by the manufacturer to meet applicable EPA emission standards found in 40 CFR 60 Subpart IIII. In addition, engine must meet any applicable state or local emission requirements (ex: California SCAQMD).

2.1.2.2 Performance Class

The voltage and frequency behavior of the generator set must be in accordance with ISO 8528 operating limit values for performance Class G3.

2.1.3 Power Ratings

Power ratings must be in accordance with EGSA 101P.

2.1.4 Transient Response

The engine-generator set governor and voltage regulator must cause the engine-generator set to respond to the maximum step load changes such that output voltage and frequency recover to and stabilize within the operational bandwidth within the transient recovery time. The engine-generator set must respond to maximum step load changes such that the maximum voltage and frequency deviations from bandwidth are not exceeded.

2.1.5 Reliability and Durability

Provide prime engine-generator sets that have both an engine and a generator capable of delivering the specified power on a prime basis with an anticipated mean time between overhauls of not less than 10,000 hours

operating with a 70 percent load factor. Cite two like engines and two like generators that have performed satisfactorily in a stationary power plant, independent from the physical location of the manufacturer's and assembler's facilities. The engine and generators should have been in operation for a minimum of 8000 actual hours at a minimum load of 70 percent of the rated output capacity. During two consecutive years of service, the units should not have experienced any failure resulting in a downtime in excess of 72 hours. Provide engines that are the same model, speed, bore, stroke, number and configuration of cylinders and rated output capacity. Provide generators that are the same model, speed, pitch, cooling, exciter, voltage regulator and rated output capacity. Each standby engine-generator set must have both an engine and a generator capable of delivering the specified power on a standby basis with an anticipated mean time between overhauls of no less than 5,000 hours operating with a load factor of 70 percent. Cite two like engines and two like generators that have performed satisfactorily in a stationary power plant, independent and separate from the physical location of the manufacturer's and assembler's facilities, for standby without any failure to start, including all periodic exercise. Provide like engines and generators that have had no failures resulting in downtime for repairs in excess of 72 hours during two consecutive years of service. Provide engines that are the same model, speed, bore, stroke, number and configuration of cylinders, and rated output capacity. Provide generators that are the same model, speed, pitch, cooling, exciter, voltage regulator and rated output capacity.

Submit a reliability and durability certification letter from the manufacturer and assembler to prove that existing facilities are and have been successfully utilizing the same components proposed to meet this specification, in similar service. Certification may be based on components, i.e. engines used with different models of generators and generators used with different engines, and does not exclude annual technological improvements made by a manufacturer in the basic standard-model component on which experience was obtained, provided parts interchangeability has not been substantially affected and the current standard model meets the performance requirements specified. Provide a list with the name of the installations, completion dates, and name and telephone number of a point of contact.

2.1.6 Vibration Isolation

Provide an engine-generator set with a vibration isolation system in accordance with the manufacturer's standard recommendation. Submit vibration isolation system performance data for the range of frequencies generated by the engine-generator set during operation from no load to full load and the maximum vibration transmitted to the floor plus description of seismic qualification of the engine-generator mounting, base, and vibration isolation. Submit torsional analysis including prototype testing or and calculations which certify and demonstrate that no damaging or dangerous torsional vibrations will occur when the prime mover is connected to the generator, at synchronous speeds, plus 10 percent. Design and qualify vibration isolation systems as an integral part of the base and mounting system in accordance with the seismic parameters specified. Where the vibration isolation system does not secure the base to the structure floor or unit foundation, provide seismic restraints in accordance with the seismic parameters specified.

2.1.7 Harmonic Requirements

Non-linear loads to be served by each engine-generator set are as indicated. The maximum linear load demand (kVA at PF) when non-linear loads will also be in use is as indicated.

2.1.8 Starting Time Requirements

Upon receipt of a signal to start, each engine generator set will start, reach rated frequency and voltage and be ready to assume load within the time specified. For standby sets used in emergency power applications, each engine generator set will start, reach rated frequency and voltage, and power will be supplied to the load terminals of the automatic transfer switch within the starting time specified.

2.2 NAMEPLATES

Provide the manufacturer's name, type or style, model or serial number and rating on a plate secured to the equipment for each major component of this specification. Provide plates and tags sized so that inscription is readily legible to operating or maintenance personnel and securely mounted to or attached in proximity of their identified controls or equipment. Lettering must be normal block lettering, a minimum of 0.25 inch high. As a minimum, provide nameplates for:

Engines	Relays
Generators	Fuel Tanks
Regulators	Governors
Pumps and pump motors	Heat exchangers (other than base mounted)
Generator Breaker	

Where the following equipment is not provided as a standard component by the engine generator set manufacturer, the nameplate information may be provided in the maintenance manual in lieu of nameplates.

Battery charger	Heaters
Battery	Silencers
	Exciters

2.2.1 Materials

Construct ID plates and tags of 16 gage minimum thickness bronze or stainless steel sheet metal engraved or stamped with inscription. Construct plates and tags not exposed to the weather or high operational temperature of the engine of laminated plastic, 0.125 inch thick, matte white finish with black center core, with lettering accurately aligned and engraved into the core.

2.2.2 Control Devices and Operation Indicators

Provide ID plates or tags for control devices and operation indicators, including valves, off-on switches, visual alarm annunciators, gages and thermometers, that are required for operation and maintenance of provided mechanical systems. Plates or tags must be minimum of 0.5 inch high and 2 inches long and must indicate component system and component function.

2.2.3 Equipment

Provide ID plates of a minimum size of 3 inches high and 5 inches long on provided equipment indicating the following information:

- a. Manufacturer's name, address, type and model number, serial number, and certificate of compliance with applicable EPA mission standards;
- b. Contract number and accepted date;
- c. Capacity or size;
- d. System in which installed; and
- e. System which it controls.

2.3 SAFETY DEVICES

Exposed moving parts, parts that produce high operating temperatures, parts which may be electrically energized, and parts that may be a hazard to operating personnel must be insulated, fully enclosed, guarded, or fitted with other types of safety devices. Install safety devices such that proper operation of the equipment is not impaired.

2.4 MATERIALS AND EQUIPMENT

Submit certification stating that where materials or equipment are specified to comply with requirements of UL, written proof of such compliance has been obtained. The label or listing of the specified agency, or a written certificate from an approved, nationally recognized testing organization equipped to perform such services, stating that the items have been tested and conform to the requirements and testing methods of the specified agency are acceptable as proof.

2.4.1 Circuit Breakers, Low Voltage

UL 489.

2.4.2 Filter Elements

Provide the manufacturer's standard fuel-oil, lubricating-oil, and combustion-air filter elements.

2.4.3 Instrument Transformers

NEMA/ANSI C12.11.

2.4.4 Revenue Metering

IEEE C57.13.

2.4.5 Pipe (Fuel/Lube-Oil, Compressed Air, Coolant, and Exhaust)

ASTM A53/A53M, or ASTM A106/A106M steel pipe. Pipe smaller than 2 inches must be Schedule 80. Pipe 2 inches and larger must be Schedule 40.

2.4.5.1 Flanges and Flanged Fittings

ASTM A181/A181M, Class 60, or ASME B16.5, Grade 1, Class 150.

2.4.5.2 Pipe Welding Fittings

ASTM A234/A234M, Grade WPB or WPC, Class 150 or ASME B16.11, 3000 lb.

2.4.5.3 Threaded Fittings

ASME B16.3, Class 150.

2.4.5.4 Valves

MSS SP-80, Class 150.

2.4.5.5 Gaskets

Manufacturer's standard.

2.4.6 Electrical Enclosures

NEMA ICS 6.

2.4.6.1 Switchboards

NEMA PB 2.

2.4.6.2 Panelboards

NEMA PB 1.

2.4.7 Electric Motors

Provide electric motors that conform to the requirements of NEMA MG 1. Motors must have sealed ball bearings and a maximum speed of 1800 rpm. Motors used indoors must have drip-proof frames; enclose those that are used outside. Alternating current motors larger than 1/2 Hp must be of the squirrel-cage induction type for operation on 208 volts or higher, 60 Hz, and three-phase power. Alternating current motors 1/2 Hp or smaller, must be suitable for operation on 120 volts, 60 Hz, and single-phase power.

2.4.8 Motor Controllers

Provide motor controllers and starters that conform to the requirements of NFPA 70 and NEMA ICS 2.

2.5 ENGINE

Each engine must operate on No. 2-D diesel fuel conforming to ASTM D975, must be designed for stationary applications and must be complete with ancillaries. The engine must be a standard production model shown in the manufacturer's catalog describing and depicting each engine-generator set and all ancillary equipment in sufficient detail to demonstrate complete

specification compliance. The engine must be naturally aspirated, supercharged, or turbocharged. The engine must be 4-stroke-cycle and compression-ignition type. The engine must be vertical in-line, V- or opposed-piston type, with a solid cast block or individually cast cylinders. The engine must have a minimum of two cylinders. Opposed-piston type engines must have more than four cylinders. Each block must have a coolant drain port. Equip each engine with an over-speed sensor.

ISO 3046. Diesel engines must be four-cycle naturally aspirated, or turbocharged, or turbocharged and intercooled; vertical in-line or vertical Vee type; designed for stationary service. Engines must be capable of immediate acceleration from rest to normal speed without intermediate idle/warm up period or pre-lubrication to provide essential electrical power. Two-cycle engines are not acceptable.

2.5.1 Sub-base Mounting

Mount each engine-generator set on a structural steel sub-base sized to support the engine, generator, and necessary accessories, auxiliaries and control equipment to produce a complete self-contained unit as standard with the manufacturer. Design the structural sub-base to properly support the equipment and maintain proper alignment of the engine-generator set in the specified seismic zone. In addition, provide sub-base with both lifting rings and jacking pads properly located to facilitate shipping and installation of the unit. Factory align engine and generator on the sub-base and securely bolt into place in accordance with the manufacturer's standard practice. Crankshaft must have rigid coupling for connection to the generator.

2.5.2 Assembly

Completely shop assemble each engine-generator set on its structural steel sub-base. Paint entire unit with manufacturer's standard paints and colors. After factory tests and before shipping, thoroughly clean and retouch painting as necessary to provide complete protection.

2.5.3 Turbocharger

If required by the manufacturer to meet the engine-generator set rating, provide turbine type driven by exhaust gas from engine cylinders, and direct connected to the blower supplying air to the engine intake manifold.

2.5.4 Intercooler

Provide manufacturer's standard intercooler for engine size specified.

2.5.5 Crankcase Protection

2.5.6 Miscellaneous Engine Accessories

Provide the following engine accessories where the manufacturer's standard design permits:

- a. Piping on engine to inlet and outlet connections, including nonstandard companion flanges.
- b. Structural steel sub-base and vibration isolators, foundation bolts, nuts, and pipe sleeves.

- c. Level jack screws or shims, as required.
- d. Rails, chocks, and shims for installation of sub-base on the foundation.
- e. Removable guard, around fan. Support guard, on engine sub-base, to suit manufacturer's standard.

2.5.7 Intercooler

Provide manufacturer's standard intercooler for engine size specified.

2.6 FUEL SYSTEM

Provide fuel system conforming to the requirements of NFPA 30 and NFPA 37 and containing the following elements.

2.6.1 Pumps

Fuel transfer pumps may be mounted on the day tank. Pump[s] must be [duplex,] horizontal, positive displacement. Direct-connect pump to motor through a flexible coupling. Equip each pump with a bypass relief valve, if not provided with an internal relief valve. Provide motor and controller in accordance with the paragraphs ELECTRIC MOTORS and MOTOR CONTROLLERS, respectively.

2.6.1.1 Main Pump

Provide engines with an engine driven pump. The pump must supply fuel at a minimum rate sufficient to provide the amount of fuel required to meet the performance indicated within the parameter schedule. Base the fuel flow rate on meeting the load requirements and all necessary recirculation.

2.6.1.2 Auxiliary Fuel Pump

Provide auxiliary fuel pumps to maintain the required engine fuel pressure, if either required by the installation or indicated on the drawings. The auxiliary pump must be driven by a dc electric motor powered by the starting/station batteries. Automatically actuate the auxiliary pump by a pressure-detecting device.

2.6.2 Fuel Filter

Provide a minimum of one full-flow fuel filter for each engine. The filter must be readily accessible and capable of being changed without disconnecting the piping or disturbing other components. Mark the inlet and outlet connections of the filter.

Provide intake filter assemblies for each engine of the oil bath or dry type, as standard with the manufacturer. Filters must be capable of removing a minimum of 92 percent of dirt and abrasive 3 microns and larger from intake air. Size filters to suit engine requirements at 100 percent of rated full load. Design unit for field access for maintenance purposes.

2.6.3 Relief/Bypass Valve

Provide a relief/bypass valve to regulate pressure in the fuel supply line, return excess fuel to a return line and prevent the build-up of

excessive pressure in the fuel system.

2.6.4 Integral Main Fuel Storage Tank

Provide each engine with an integral main fuel tank. Each tank must be factory installed and provided as an integral part of the generator manufacturer's product. Provide each tank with connections for fuel supply line, fuel return line, local fuel fill port, gauge, vent line, and float switch assembly. Provide a fuel return line cooler as recommended by the manufacturer and assembler. The temperature of the fuel returning to the tank must be below the flash point of the fuel. Mount the tank within the enclosure for each engine-generator set provided with weatherproof enclosures. The fuel fill line must be accessible without opening the enclosure.

- a. All Tanks: UL 142. Provide double wall (110 percent containment) fuel tanks with a capacity as indicated. Epoxy coat day tanks inside and prime and paint outside. Construct tanks of not less than 3/16 inch steel plate with welded joints and necessary stiffeners on exterior of tank. Provide a braced structural steel framework support. Weld tank top tight. Provide 4 1/2 inch square inspection port with a 2 inch NPT fill connection and spill box. Provide proper normal and emergency venting for the primary tank and emergency venting only for the secondary tank / containment basin in accordance with UL 142 requirements. Provide an overflow or return line between the fuel day tank and storage tank in accordance with NFPA 37.
- b. Float Switches for Day Tanks: Provide tank-top mounted or external float cage, single-pole, single-throw type designed for use on fuel oil tanks. Arrange high level float switches to close on rise of liquid level, and low level float switches to close on fall of liquid level. Mount float cage units with isolating and drain valves. Contacts must be suitable for the station battery voltage.
 - (1) Critical low level float switch which must activate at 5 percent of normal liquid level must shut engine off.
 - (2) Low-low level float switch which must activate alarm at 30 percent of normal liquid level.
 - (3) Low level float switch which must open the fuel oil solenoid valve and start the remote fuel transfer pump at 75 percent of normal liquid level.
 - (4) High level float switch which must close the fuel oil solenoid valve and stop the remote fuel transfer pump at 90 percent of normal liquid level.
 - (5) Critical high level float switch which must activate alarm at 95 percent of normal liquid level.
- c. Leak Detector Switch for All Tanks: Actuates when fuel is detected in containment basin, stops fuel transfer pump, and closes the fuel oil solenoid valve.
- d. Tank Gages for All Tanks: Provide buoyant force type gages for fuel tanks with dial indicator not less than 4 inches in size and arranged for top mounting. Calibrate each reading dial or scale for its specific tank to read from empty to full, with intermediate points of

1/4, 1/2, and 3/4.

2.6.4.1 Capacity

Each tank must have capacity [as shown] [to supply fuel to the engine for an uninterrupted 48-hour period at 100 percent rated load without being refilled.

2.6.4.2 Local Fuel Fill

Each local fuel fill port on the day tank must have a screw-on cap.

2.6.4.3 Fuel Level Controls

Provide tanks with a float-switch assembly to perform the following functions:

- a. Activate the "Low Fuel Level" alarm at 70 percent of the rated tank capacity.
- b. Activate the "Overfill Fuel Level" alarm at 95 percent of the rated tank capacity.

2.6.4.4 Arrangement

Integral tanks may allow gravity flow into the engine. Gravity flow tanks and any tank that allows a fuel level above the fuel injectors must have an internal or external factory installed valve located as near as possible to the shell of the tank. The valve must close when the engine is not operating. Provide integral day tanks with any necessary pumps to supply fuel to the engine as recommended by the generator set manufacturer. The fuel supply line from the tank to the manufacturer's standard engine connection must be welded pipe.

2.7 LUBRICATION

Provide engine with a separate lube-oil system conforming to NFPA 30 and NFPA 37. Pressurize each system by engine-driven pumps. Regulate system pressure as recommended by the engine manufacturer. Provide a pressure relief valve on the crankcase for closed systems. Vent the crankcase in accordance with the manufacturer's recommendation. Do not vent the crankcase to the engine exhaust system. Crankcase breathers, if provided on engines installed in buildings or enclosures, must be piped to vent to the outside. The system must be readily accessible for service such as draining, refilling, etc. Each system must permit addition of oil and have oil-level indication with the set operating. The system must utilize an oil cooler as recommended by the engine manufacturer.

2.7.1 Lube-Oil Filter

Provide one full-flow filter for each pump. The filter must be readily accessible and capable of being changed without disconnecting the piping or disturbing other components. Mark inlet and outlet connections.

2.7.2 Lube-Oil Sensors

Equip each engine with lube-oil pressure sensors located downstream of the filters and provide signals for required indication and alarms. Submit two complete sets of filters, required for maintenance, supplied in a

suitable storage box. Provide these filters in addition to filters replaced after testing.

2.7.3 Precirculation Pump

Provide a motor-driven precirculation pump powered by the station battery, complete with motor starter, if recommended by the engine manufacturer.

2.8 COOLING SYSTEM

Provide each engine with its own cooling system to operate automatically while its engine is running. The cooling system coolant must use a combination of water and ethylene-glycol sufficient for freeze protection at the minimum winter outdoor temperature specified. The maximum temperature rise of the coolant across each engine must not exceed that recommended below. Submit a letter which certifies that the engine-generator set and cooling system function properly in the ambient temperature specified, stating the following values:

- a. The maximum allowable inlet temperature of the coolant fluid.
- b. The minimum allowable inlet temperature of the coolant fluid through the engine.
- c. The maximum allowable temperature rise in the coolant fluid through the engine.
- d. The minimum allowable inlet fuel temperature.

2.8.1 Coolant Pumps

Provide centrifugal coolant pumps. Each engine must have an engine-driven primary pump. Provide secondary pumps that are electric motor driven and have automatic controllers.

2.8.2 Heat Exchanger

Provide heat exchanger with the size and capacity to limit the maximum allowable temperature rise in the coolant across the engine to that recommended and submitted for the maximum summer outdoor design temperature and site elevation. Submit manufacturer's data to quantify heat rejected to the space with the engine generator set at rated capacity. Provide heat exchangers that are corrosion resistant, suitable for service in ambient conditions of application.

2.8.2.1 Fin-Tube-Type Heat Exchanger (Radiator)

Heat exchanger may be factory coated with corrosion resistant film, provided that corrective measures are taken to restore the heat rejection capability of the radiator to the initial design requirement via oversizing, or other compensating methods. Provide internal surfaces that are compatible with liquid fluid coolant used. Materials and coolant are subject to approval by the Contracting Officer. Provide heat exchangers that are pressure type incorporating a pressure valve, vacuum valve and a cap. Design caps for pressure relief prior to removal. Provide heat exchanger and cooling system that is capable of withstanding a minimum pressure of 7 psi and protect with a strong grille or screen guard. Provide heat exchanger with at least two tapped holes; equip one tapped hole with a drain cock, and plug the rest.

Provide for each engine-generator set, as standard with the manufacturer.

- a. Design Conditions: Each radiator unit must have ample capacity to remove not less than the total Btu per hour of heat rejected by its respective engine at 100 percent full-rated load to the jacket water, fuel oil, and lubricating oil system, and intercooler. Radiator capacity must be rated at optimum temperature of coolant leaving the engine and intercooler as recommended by the engine manufacturer with an ambient dry bulb air temperature outside the enclosure of 120 degrees F maximum, and 85 degrees F minimum at the site elevation specified in the paragraph SITE CONDITIONS, and with the coolant mixture specified in the paragraph ENGINE CAPACITY. Pressure drop through the radiator must not exceed 6 psi when circulating the maximum required coolant flow. Radiator air velocity must be a maximum of 1500 feet per minute.
- b. Engine Mounted Radiator Construction: Radiator fan must direct airflow from the engine outward through the radiator. Fan must be V-belt driven directly from the engine crankshaft. Radiator fan must have sufficient capacity to meet design conditions against a static restriction of 0.5 inch of water. Fan static capacity must be adjusted to suit the ductwork furnished. Cooling section must have a tube and fin-type core consisting of copper or copper base alloy tubes with nonferrous fins. Select engine-driven fans for quiet vibration-free operation. Make provision for coolant expansion either by self-contained expansion tanks or separately mounted expansion tanks, as standard with the manufacturer. Provide suitable guards for each fan and drive.
- c. Coolant solution must be a mixture of clean water and ethylene glycol, 50 percent by volume each. Provide an anti-freeze solution tester suitable for the mixture.

2.8.2.2 Shell and U-Tube Type Heat Exchanger

Provide multiple pass shell, U-tube type heat exchanger. Exchanger must operate with low temperature water in the shell and high temperature water in the tubes. Provide exchangers that are constructed in accordance with ASME BPVC SEC VIII D1 and certified with ASME stamp secured to the unit. Provide U-tube bundles that are completely removable for cleaning and tube replacement and free to expand with the shell. Construct shells of seamless steel pipe or welded steel. Tubes must be cupronickel or inhibited admiralty, constructed in accordance with ASTM B395/B395M, suitable for the temperatures and pressures specified. Tubes less than 3/4 inch unless otherwise indicated are not acceptable. Design shell side and tube side for 150 psig working pressure and factory tested at 300 psig. Locate high and low temperature water and pressure relief connections in accordance with the manufacturers standard practice. Water connections larger than 3 inches must be ASME Class 150 flanged. Water pressure loss through clean tubes must be as recommended by the engine manufacturer. Minimum water velocity through tubes must be 1 fps and assure turbulent flow. Provide one or more pressure relief valves for each heat exchanger in accordance with ASME BPVC SEC VIII D1. The aggregate relieving capacity of the relief valves must be not less than that required by the above code. Install discharge from the valves indicated. Install the relief valves on the heat exchanger shell. Install a drain connection with 3/4 inch hose bib at the lowest point in the system near the heat exchanger. Install additional drain connection with threaded cap or plug

wherever required for thorough draining of the system.

2.8.3 Thermostatic Control Valve

Provide a modulating type, thermostatic control valve in the coolant system to maintain the coolant temperature range submitted in paragraph SUBMITTALS.

2.8.4 Temperature Sensors

Equip each engine with coolant temperature sensors. Provide temperature sensors with signals for pre-high and high indication and alarms.

2.9 SOUND LIMITATIONS

Submit sound power level data for the packaged unit operating at 100 percent load in a free field environment. The data should demonstrate compliance with the sound limitation requirements of this specification. Submit certification from the manufacturer stating that the sound emissions meet the specification. Do not exceed the following sound pressure levels in any of the indicated frequencies when measured in a free field at a radial distance of 22.9 feet 7 meters at 45 degrees apart in all directions when operating at 100 percent load.

Frequency Band (Hz)	Maximum Acceptable Sound Level (Decibels)
31	N/A
63	81.6
125	93.2
250	87.7
500	84.9
1,000	85.0
2,000	84.4
4,000	83.2
8,000	86.7

2.10 AIR INTAKE EQUIPMENT

Locate filters and silencers in locations that are convenient for servicing. Provide high-frequency filter type silencers and locate in the air intake system as recommended by the engine manufacturer. Provide silencer to reduce the noise level at the air intake so that the indicated pressure levels specified in paragraph SOUND LIMITATIONS will not be exceeded. A combined filter-silencer unit meeting requirements for the separate filter and silencer items may be provided. Provide rubber expansion elements in air-intake lines.

Provide intake filter assemblies for each engine of the oil bath or dry type, as standard with the manufacturer. Filters must be capable of

removing a minimum of 92 percent of dirt and abrasive 3 microns and larger from intake air. Size filters to suit engine requirements at 100 percent of rated full load. Design unit for field access for maintenance purposes.

2.11 EXHAUST SYSTEM

Provide a separate and complete system for each engine. Support piping to minimize vibration. Where a V-type engine is provided, use a V-type connector, with necessary flexible sections and hardware, to connect the engine exhaust outlets.

2.11.1 Flexible Sections and Expansion Joints

Provide a flexible section at each engine and an expansion joint at each muffler. Provide flexible sections and expansion joints that have flanged connections. Provide flexible sections made of convoluted seamless tube without joints or packing. Provide bellows type expansion joints. Provide stainless steel expansion and flexible elements suitable for engine exhaust gas at the maximum exhaust temperature that is specified by the engine manufacturer. Provide expansion and flexible elements that are capable of absorbing vibration from the engine and compensation for thermal expansion and contraction.

2.11.2 Exhaust Muffler

Provide a chamber type exhaust muffler. Provide welded steel muffler designed for [outside] [inside] [vertical] [horizontal] mounting. Provide eyebolts, lugs, flanges, or other items as necessary for support in the location and position indicated. Do not exceed the engine manufacturer's recommended pressure drop. Outside mufflers must be zinc coated or painted with high temperature 400 degrees F resisting paint. The muffler and exhaust piping together must reduce the noise level to less than the maximum acceptable level listed for sound limitations in paragraph SOUND LIMITATIONS. Provide muffler with a drain valve, nipple, and cap at the low-point of the muffler.

A critical class silencer must be provided for each engine which will reduce the exhaust sound spectrum by the following listed values at a 75 foot radius from the outlet, with generator set loaded to rated capacity and clear weather. Inlet and outlet connections must be flanged.

Octave Band Center Frequency (Hertz)								
Minimum Silencer Attenuation Decibels	63	125	250	500	1000	2000	4000	8000
Hospital Grade	20	40	50	45	32	30	30	30

2.11.3 Exhaust Piping

Slope horizontal sections of exhaust piping downward away from the engine to a drip leg for collection of condensate with drain valve and cap. Changes in direction must be long radius. Insulate exhaust piping, mufflers and silencers installed inside any building in accordance with paragraph THERMAL INSULATION and covered to protect personnel. Provide vertical exhaust piping with a hinged, gravity-operated, self-closing, rain cover.

Field installed exhaust piping must conform to the following:

- a. Exhaust Piping: Provide flanges for connections to engines, exhaust mufflers, and flexible connections. Provide steel pipe conforming to ASTM A53/A53M for each engine complete with necessary fittings, flanges, gaskets, bolts, and nuts. Exhaust piping must be Schedule 40 pipe for 12 inches and smaller. Exhaust piping exposed to weather shall be 316L stainless steel in accordance with ASTM A312/A312M, with 316L stainless steel flanges and fittings. Flanges must be Class 150 slip-on forged steel welding flanges in accordance with ASME B16.5, with material in accordance with ASTM A181/A181M, Grade I. Fittings must be butt welding conforming to ASTM A234/A234M, with wall thickness same as adjoining piping. Fittings must be of same material and wall thickness as pipe. Built-up miter welded fittings may be used. Miter angles of each individual section must not exceed 22.5 degrees total and not more than 11.25 degrees relative to the axis of the pipe at any one cut. Gaskets for exhaust piping must be of high temperature asbestos-free material suitable for the service and must be ASME B16.21, composition ring, 0.0625 inch thick. Bolting material for exhaust flanges must be alloy-steel bolt-studs conforming to ASTM A193/A193M, Grade B7 bolts and alloy-steel nuts conforming to ASTM A194/A194M, Grade 7. Bolts must be of sufficient length to obtain full bearing on the nuts and must project not more than two full threads beyond the nut. Provide stainless steel counterbalance type rain caps at termination of each exhaust pipe.
- b. Expansion (Flexible) Joints: Provide sections of multiple corrugated stainless steel expansion joints [with liners] in the engine exhaust piping for each engine to absorb expansion strains and vibration transmitted to the piping. Flexible joints must be suitable for operation at 200 degrees F above normal exhaust gas temperature at 100 percent load, 10,000 cycles, minimum. Joints must be flanged and located between engine exhaust manifold and exhaust piping, must be the same size as exhaust piping size, and must be designed and constructed for engine exhaust service.
- c. Hangers and Supports: MSS SP-58.
- d. Piping Insulation: Provide exhaust piping insulation in accordance with Section 23 07 00 THERMAL INSULATION FOR MECHANICAL SYSTEMS.

2.12 EMISSIONS

The finished installation must comply with Federal, state, and local regulations and restrictions regarding the limits of emissions. Submit certification from the engine manufacturer stating that the engine exhaust emissions meet the federal, state, and local regulations and restrictions specified. At a minimum this certification must include emission factors for criteria pollutants including nitrogen oxides, carbon monoxide, particulate matter, sulfur dioxide, non-methane hydrocarbon, and for hazardous air pollutants (HAPs).

2.13 STARTING SYSTEM

Provide starting system for [standby engine generator sets used in emergency applications in accordance with NFPA 99 and NFPA 110 and as follows.

2.13.1 Controls

Provide an engine control switch with functions including: run/start (manual), off/reset, and, automatic mode. Provide start-stop logic for adjustable cycle cranking and cool-down operation. Arrange the logic for [manual starting] [and] [fully automatic starting in accordance with paragraph AUTOMATIC ENGINE-GENERATOR-SET SYSTEM OPERATION]. Provide electrical starting systems with an adjustable cranking limit device to limit cranking periods from 1 second up to the maximum duration.

2.13.2 Capacity

Provide starting system with sufficient capacity, at the maximum indoor summer temperature specified to crank the engine without damage or overheating. The system must provide a minimum of three cranking periods with 15 second intervals between cranks. Each cranking period must have a maximum duration of 15 seconds. Starting must be accomplished using an adequately sized dc starter system with a positive shift solenoid to engage the starter motor and to crank the engine continuously for 60 seconds without overheating.

2.13.3 Electrical Starting

Manufacturers recommended dc system, utilizing a negative circuit ground. Starting motors must be in accordance with SAE ARP892.

2.13.3.1 Battery

Provide a starting battery system including the battery, battery rack, intercell connectors, spacers, automatic battery charger with overcurrent protection, metering and relaying. Provide battery in accordance with SAE J537. Size critical system components (rack, protection, etc.) to withstand the seismic acceleration forces specified. Provide lead-acid battery with sufficient capacity, at the minimum indoor and maximum indoor temperature specified, to provide the specified cranking periods. Valve-regulated lead-acid batteries are not acceptable.

2.13.3.2 Battery Charger

Provide a current-limiting battery charger, conforming to UL 1236, that automatically recharges the batteries. Submit battery charger sizing calculations. The charger must be capable of an equalize charging rate [for recharging fully depleted batteries within 24 hours which is manually adjustable in a continuous range and a floating charge rate for maintaining the batteries at fully charged condition. Provide an ammeter to indicate charging rate. Provide a voltmeter to indicate charging voltage. Provide a timer for the equalize charging-rate setting. A battery is considered to be fully depleted when the output voltage falls to a value which will not operate the engine generator set and its components.

Provide 120 volt ac, enclosed, automatic equalizing, dual-rate, solid-state, constant voltage type battery charger with automatic ac line compensation. DC output must be voltage regulated and current limited. Charger must have two ranges, float and equalize, and must provide continuous taper charging. The charger must have a continuous output rating of not less than 10 amperes and must be sized to recharge the engine starting batteries in a minimum of 8 hours while providing the control power needs of the engine-generator set. Enclosure must be

NEMA ICS 6, Type 1. The following accessories must be included:

- a. DC ammeter
- b. DC voltmeter
- c. Equalize light
- d. AC on light
- e. Low voltage light
- f. High voltage light
- g. Equalize test button/switch
- h. AC circuit breaker
- i. Low dc voltage alarm relay
- j. High dc voltage alarm relay
- k. Current failure relay
- l. AC power failure relay

2.13.4 Storage Batteries

Provide storage batteries of suitable rating and capacity to supply and maintain power for the remote alarm annunciator for a period of 90 minutes minimum without the voltage applied falling below 87.5 percent of normal. Provide a 120 volt ac automatic battery charger.

2.13.5 Exerciser

Provide exerciser in accordance with Section 26 36 23 AUTOMATIC TRANSFER SWITCH AND BY-PASS/ISOLATION SWITCH.

2.14 GOVERNOR

Provide a forward acting type engine speed governor system. Steady-state frequency band and frequency regulation (droop) must be in accordance with the operating limit values of the performance class specified in the paragraph PERFORMANCE CLASS.

Provide engine with a governor which maintains the frequency within a bandwidth of the rated frequency, over a steady-state load range of zero to 100 percent of rated output capacity. Configure the governor for safe manual adjustment of the speed/frequency during operation of the engine-generator set, without special tools, from 90 to 110 percent of the rated speed/frequency, over a steady state load range of 0 to 100 percent or rated capacity. Submit two complete sets of special tools required for maintenance (except for electronic governor handset). Special tools are those that only the manufacturer provides, for special purposes, or to reach otherwise inaccessible parts. Provide a suitable tool box for tools. Provide one handset for each electronic governor when required to indicate and/or change governor response settings. Maintain the midpoint of the frequency bandwidth linearly for steady-state loads over the range of zero to 100 percent of rated output capacity, with 3 percent droop

configured for safe, manual, external adjustment of the droop from zero to 0.33 percent for droop governors.

2.15 GENERATOR

Provide synchronous type, one or two bearing, generator conforming to the performance criteria in NEMA MG 1, equipped with winding terminal housings in accordance with NEMA MG 1, equipped with an amortisseur winding, and directly connected to the engine. Submit calculations of the engine and generator output power capability, including efficiency and parasitic load data. Provide Class H insulation.

- a. Select NEMA MG 1, Part 16, standby duty, and temperature rise of 130 degrees C for engine-generator sets which are expected to operate for less than 300 hours per year. Select NEMA MG 1, Part 22, continuous duty, and temperature rise of 105 degrees C for engine-generator sets expected to operate 300 hours or greater per year or rated 300 kW and above.
- b. Select 2/3 pitch design option for engine-generator sets rated 300 kW and above.
- c. Select 10-12 lead re-connectable for engine-generator sets rated 300 kW to 800 kW.
- d. For applications requiring high SCR loading or in harsh environments laden with salts and chemicals, select vacuum pressure impregnation (VPI) insulated coils. When engine-generator sets are rated 800 kW and larger, also select form wound coils.
- e. Provide salient-pole type, ac, brushless-excited, revolving field, air-cooled, self-ventilated, drip-proof guarded, coupled type, synchronous generator conforming to NEMA MG 1, Part [16] [22], and IEEE C50.12. Generator must be rated for standby duty at 100 percent of the power rating of the engine-generator set as specified in paragraph ENGINE-GENERATOR SET RATINGS AND PERFORMANCE. Temperature rise of each of the various parts of the generator must not exceed 130 degrees C as measured by resistance, based on a maximum ambient temperature of 40 degrees C. Winding insulation must be Class H.
- f. Stator: Stator windings must be 2/3 pitch design.
- g. Rotor: The rotor must have connected amortisseur windings.
- h. Generator Space Heater: Provide 120 volt ac heaters. Heater capacity must be as recommended by the generator manufacturer to aid in keeping the generator insulation dry.
- i. Grounding: Provide non-corrosive steel grounding pads located at two opposite mounting legs.
- j. Filters: Provide manufacturer's standard generator cooling air filter assembly.
- k. Design generator to protect against mechanical, electrical and thermal damage due to vibration, 25 percent overspeeds, or voltages and temperatures at a rated output capacity of 110 percent for prime applications and 100 percent for standby applications.

- l. Provide generator ancillary equipment meeting the short circuit requirements of NEMA MG 1. Select drip-proof guarded option for generators without weatherproof enclosures.
- m. Submit manufacturer's standard data for each generator (prototype data at the specified rating or above is acceptable), listing the following information:
 - (1) Direct-Axis sub-transient reactance (per unit).
 - (2) The generator kW rating and short circuit current capacity (both symmetric and asymmetric).

2.15.1 Current Balance

At 100 percent rated output capacity, and load impedance equal for each of the 3 phases, the permissible current difference between any 2 phases must not exceed 2 percent of the largest current on either of the 2 phases. Submit certification stating that the flywheel has been statically and dynamically balanced and is capable of being rotated at 125 percent of rated speed without vibration or damage.

2.15.2 Voltage Balance

At any balanced load between 75 and 100 percent of rated output capacity, the difference in line-to-neutral voltage among the 3 phases must not exceed 1 percent of the average line-to-neutral voltage. For a single phase load condition, consisting of 25 percent load at unity power factor placed between any phase and neutral with no load on the other 2 phases, the maximum simultaneous difference in line-to-neutral voltage between the phases must not exceed 3 percent of rated line to neutral voltage. The single-phase load requirement must be valid utilizing normal exciter and regulator control. The interpretation of the 25 percent load for single phase load conditions means 25 percent of rated current at rated phase voltage and unity power factor.

2.15.3 Waveform

The deviation factor of the line-to-line voltage at zero load and at balanced rated output capacity must not exceed 10 percent. The RMS of all harmonics must be less than 5.0 percent and that of any one harmonic less than 3.0 percent of the fundamental at rated output capacity. Design and configure engine-generator to meet the total harmonic distortion limits of IEEE 519.

2.16 EXCITER

Provide brushless generator exciter. Provide semiconductor rectifiers that have a minimum safety factor of 300 percent for peak inverse voltage and forward current ratings for all operating conditions, including 110 percent generator output at 104 degrees F ambient. The exciter and regulator in combination must maintain generator-output voltage within the limits specified.

Provide a brushless excitation system consisting of an exciter and rotating rectifier assembly [, and permanent magnet generator] integral with the generator and a voltage regulator. Insulation class for parts integral with the generator must be as specified in paragraph GENERATOR. System must provide a minimum short circuit of 300 percent rated

engine-generator set current for at least 10 seconds. Steady state voltage regulation must be in accordance with the operating limit values of the performance class specified in the paragraph PERFORMANCE CLASS.

- a. Exciter and Rotating Rectifier Assembly: Rectifiers must be provided with surge voltage protection.
- b. Permanent Magnet Generator: Provide a voltage spike suppression device for permanent magnet generator (PMG) excitation systems.
- c. Voltage Regulator: Voltage regulator must be solid state or digital, automatic, three-phase sensing, volts per hertz type regulator. Regulator must receive its input power from a PMG. Voltage variation for any 40 degree C change over the operating temperature range must be less than plus or minus 1.0 percent. Operating temperature must be minus 40 degree C to plus 70 degree C. Voltage adjust range must be plus to minus 5.0 percent of nominal. Inherent regulator features must include over excitation shutdown.

2.16.1 Electromagnetic Interference (EMI) Suppression

Provide as an integral part of the generator and excitation system, EMI suppression complying with MIL-STD-461.

2.17 VOLTAGE REGULATOR

Provide a solid-state voltage regulator, separate from the exciter, for each generator. Maintain the voltage within a bandwidth of the rated voltage, over a steady-state load range of zero to 100 percent of rated output capacity. Configure regulator for safe manual adjustment of the engine-generator voltage output without special tools, during operation, from 90 to 110 percent of the rated voltage over the steady state load range of 0 to 100 percent of rated output capacity. Regulation drift exceeding plus or minus 0.5 percent for an ambient temperature change of 68 degrees F is not acceptable. Reactive droop compensation or reactive differential compensation must load share the reactive load proportionally between sets during parallel operation. Provide voltage regulator with a maximum droop of 2 percent of rated voltage over a load range from 0 to 100 percent of rated output capacity and automatically maintain the generator output voltage within the specified operational bandwidth.

2.18 GENERATOR ISOLATION AND PROTECTION

Provide necessary devices for electrical protection and isolation of each engine-generator set and its ancillary equipment. The generator circuit breaker (IEEE Device 52) ratings must be consistent with the generator rated voltage and frequency, with continuous, short circuit withstand, and interrupting current ratings to match the generator capacity. Provide electrically operated generator circuit breaker. Mount a set of surge capacitors at the generator terminals. Provide monitoring and control devices.

The generator circuit breaker must comply with UL 489 requirements for molded case, adjustable thermal magnetic trip type circuit breaker. The circuit breaker continuous current rating must be adequate for the power rating of the engine-generator set and the circuit breaker must be rated to withstand the short circuit current provided by the generator set. Provide circuit breaker in a NEMA ICS 6, Type 1 enclosure mounted on the engine-generator set.

2.18.1 Switchboards

Provide free-standing, metal-enclosed, general purpose, 3-phase, 4-wire, 600 volt rated, with neutral bus and continuous ground bus, switchboards conforming to NEMA PB 2 and UL 891. Neutral bus and ground bus capacity must be full capacity. Provide panelboards conforming to NEMA PB 1. Provide enclosure designs, construction, materials and coatings as indicated. Bus continuous current rating must be as indicated. Current withstand (short circuit rating) must be equal to the breaker interrupting rating. Provide copper buses.

2.18.2 Devices

Provide switches, circuit breakers, switchgear, fuses, relays, and other protective devices as specified in Section 26 36 23 AUTOMATIC TRANSFER SWITCHES AND BY-PASS/ISOLATION SWITCH.

2.19 SAFETY SYSTEM

Provide and install devices, wiring, remote panels, and local panels, etc., as a complete system to automatically activate the appropriate signals and initiate the appropriate actions. Provide a safety system with a self-test method to verify its operability. Provide alarm signals that have manual acknowledgment and reset devices. The alarm signal systems must reactivate for new signals after acknowledgment is given to any signal. Configure the systems so that loss of any monitoring device will be dealt with as an alarm on that system element.

2.19.1 Audible Signal

Provide audible alarm signal sound at a frequency of 70 Hz at a volume of 75 dB at 10 feet. The sound must be continuously activated upon alarm and silenced upon acknowledgment. Locate signal devices as shown.

2.19.2 Visual Signal

The visual alarm signal must be a panel light. The light must be normally off, activated to be blinking upon alarm. The light must change to continuously lit upon acknowledgement. If automatic shutdown occurs, the display must maintain activated status to indicate the cause of failure and must not be reset until cause of alarm has been cleared and/or restored to normal condition. Shutdown alarms must be red; all other alarms must be amber.

2.19.3 Alarms and Action Logic

2.19.3.1 Shutdown

Accomplish simultaneous activation of the audible signal, activation of the visual signal, stopping the engine, and opening the generator main circuit breakers.

2.19.3.2 Problem

Accomplish activation of the visual signal.

2.19.4 Safety Indications and Shutdowns

Provide a local alarm panel with the following shutdown and alarm functions in accordance with NFPA 99 and NFPA 110 level 1 mounted either on or adjacent to the engine generator set.

A remote alarm panel is required for audible alarms, e.g., in the control room.

Indicator Function (at battery voltage)	NFPA 99 Level 1 CV S RA	NFPA 110 Level 1 CV S RA	NFPA 110 Level 2 CV S RA
Overcrank	X X X	X X X	X X O
Low water temperature	X NA X	X NA X	X NA O
High engine temperature pre-alarm	X NA X	X NA X	O NA NA
High engine temperature	X X X	X X X	X X O
Low lube oil pressure pre-alarm	X NA X	NA NA NA	NA NA NA
Low lube oil pressure	X X X	X X X	X X O
Overspeed	X X X	X X X	X X O
Low fuel main tank	X NA X	X NA X	O NA O
Low coolant level	X O X	X O X	X O X
EPS supplying load	X NA NA	X NA NA	O NA NA
Control switch not in automatic position	X NA X	X NA X	X NA X
High battery voltage	X NA NA	X NA NA	O NA NA
Low cranking voltage	X NA X	X NA X	O NA NA
Low voltage in battery	X NA NA	X NA NA	O NA NA
Battery charger ac failure	X NA NA	X NA NA	O NA NA
Lamp test	X NA NA	X NA NA	X NA NA
Contacts for local and remote common alarm	X NA X	X NA X	X NA X
Audible alarm silencing switch	NA NA X	NA NA X	NA NA O

Indicator Function (at battery voltage)	NFPA 99 Level 1 CV S RA	NFPA 110 Level 1 CV S RA	NFPA 110 Level 2 CV S RA
Low starting air pressure	X NA NA	X NA NA	O NA NA
Low starting hydraulic pressure	X NA NA	X NA NA	O NA NA
Air shutdown damper when used	X X X	X X X	X X O
Remote emergency stop	NA X NA	NA X NA	NA X NA
Symbology: CV: Control panel-mounted visual. S: Shutdown of EPS indication. RA: Remote audible. Symbology: CV: Control panel-mounted visual. S: Shutdown of EPS indication. RA: Remote audible. X: Required. O: Optional. NA: Not applicable.			

2.19.5 Time-Delay on Alarms

For startup of the engine-generator set, install time-delay devices bypassing the low lubricating oil pressure alarm during cranking, and the coolant-fluid outlet temperature alarm. Submit the magnitude of monitored values which define alarm or action set points, and the tolerance (plus and/or minus) at which the devices activate the alarm or action for items contained within the alarm panels. The lube-oil time-delay device must return its alarm to normal status after the engine starts. The coolant time-delay device must return its alarm to normal status 5 minutes after the engine starts.

2.20 ENCLOSURES

2.20.1 Enclosures

Design enclosures for the application and environment, conforming to NEMA ICS 6. Locking mechanisms are optional.

Provide for each engine-generator set and fabricate from 16 gage minimum stainless steel in accordance with the manufacturer's standard design. Provide a complete, weatherproof enclosure for the engine, generator, and auxiliary systems and equipment. Support exhaust piping and silencer so that the turbocharger is not subjected to exhaust system weight or lateral forces generated in connecting piping that exceed the engine manufacturer's maximum allowed forces and moments. The housing must have sufficient louvered openings to allow entrance of outside air for engine and generator

cooling at full load. Design louvered openings to exclude driving rain and snow. Provide properly arranged and sized, hinged panels in the enclosure to allow convenient access to the engine, generator, and control equipment for maintenance and operational procedures. Provide hinged panels with spring type latches which must hold the panels closed securely and will not allow them to vibrate. Brace the housing internally to prevent excessive vibration when the set is in operation.

2.20.2 Electronic

Electronic indicating instruments must be true RMS indicating instruments, 100 percent solid state, state-of-the-art, microprocessor controlled to provide specified functions. Provide control, logic, and function devices that are compatible as a system, sealed, dust and water tight, and that utilize modular components with metal housings and digital instrumentation. Provide an interface module to decode serial link data from the electronic panel and translate alarm, fault and status conditions to set of relay contacts. Instrument accuracy less than 98 percent for unit mounted devices and 99 percent for control room, panel mounted devices, throughout a temperature range of minus 4 to 158 degrees F is not acceptable. Provide LED or back lit LCD data display. Additionally, the display must provide indication of cycle programming and diagnostic codes for troubleshooting. Numeral height must be 0.5 inch.

2.20.3 Parameter Display

Provide indication or readouts of the tachometer, lubricating-oil pressure, ac voltmeter, ac ammeter, frequency meter, and safety system parameters. Specify a momentary switch for other panels.

2.21 SURGE PROTECTION

Electrical and electronic components must be protected from, or designed to withstand the effects of surges from switching and lightning.

2.22 AUTOMATIC ENGINE-GENERATOR-SET SYSTEM OPERATION

Provide fully automatic operation for the following operations: engine generator set starting and load transfer upon loss of normal source; retransfer upon restoration of the normal source; sequential starting; paralleling, and load-sharing for multiple engine-generator sets; and stopping of each engine-generator set after cool-down. Devices must automatically reset after termination of their function.

2.22.1 Automatic Transfer Switch

Provide automatic transfer switches in accordance with Section 26 36 23 AUTOMATIC TRANSFER SWITCH AND BY-PASS/ISOLATION SWITCH.

2.22.2 Monitoring and Transfer

Provide devices to monitor voltage and frequency for the normal power source and each engine-generator set, and control transfer from the normal source and retransfer upon restoration of the normal source. Describe functions, actuation, and time delays as described in Section 26 36 23 AUTOMATIC TRANSFER SWITCH AND BY-PASS/ISOLATION SWITCH.

2.23 MANUAL ENGINE-GENERATOR-SET SYSTEM OPERATION

Provide complete facilities for manual starting and testing without load, loading and unloading of each set.

2.24 BASE

Provide a steel base. Design the base to rigidly support the engine-generator set, ensure permanent alignment of rotating parts, be arranged to provide easy access to allow changing of lube-oil, and ensure that alignment is maintained during shipping and normal operation. The base must permit skidding in any direction during installation and must withstand and mitigate the affects of synchronous vibration of the engine and generator. Provide base with suitable holes for anchor bolts and jacking screws for leveling.

2.25 THERMAL INSULATION

Provide thermal insulation.

2.26 PAINTING AND FINISHING

Clean, prime and paintthe engine-generator set in accordance with the manufacturer's standard color and practice.

2.27 FACTORY INSPECTION AND TESTS

Submit six complete reproducible copies of the factory inspection result on the checklist format specified below. Perform the factory tests on each engine-generator set. The component manufacturer's production line test is acceptable as noted. Run each engine-generator set for at least 1 hour at rated output capacity prior to inspections. Complete inspections and make all necessary repairs prior to testing. Use engine generator controls and protective devices that are provided by the generator set manufacturer as part of the standard package for factory tests. When controls and switchgear are not provided as part of the generator set manufacturer's standard package, the actual controls and protective devices provided for the project are not required to be used during the factory test. The Contracting Officer may provide one or more representatives to witness inspections and tests.

2.27.1 Factory Inspection

Perform inspections prior to beginning and after completion of testing of the assembled engine-generator set. Look for leaks, looseness, defects in components, proper assembly, etc. and note any item found to be in need of correction as a necessary repair. Use the following checklist for the inspection:

INSPECTION ITEM	GOOD	BAD	NOTES
Drive belts			
Governor and adjustments			
Engine timing mark			

INSPECTION ITEM	GOOD	BAD	NOTES
Starting motor			
Starting aids			
Coolant type and concentration			
Radiator drains			
Block coolant drains			
Coolant fill level			
All coolant line connections			
All coolant hoses			
Combustion air filter			
Combustion air silencer			
Lube oil type			
Lube oil sump drain			
Lube-oil filter			
Lube-oil-level indicator			
Lube-oil-fill level			
All lube-oil line connections			
All lube-oil lines			
Fuel type and amount			
All fuel-line connections			
All fuel lines			
Fuel filter			
Coupling and shaft alignment			
Voltage regulators			
Battery-charger connections			
All wiring connections			
Instrumentation			

INSPECTION ITEM	GOOD	BAD	NOTES
Hazards to personnel			
Base			
Nameplates			
Paint			
Exhaust-heat recovery unit			
Switchboard			
Switchgear			

2.27.2 Factory Tests

Submit a letter giving notice of the proposed dates of factory inspections and tests at least 14 days prior to beginning tests, including:

- a. A detailed description of the manufacturer's procedures for factory tests at least 14 days prior to beginning tests.
- b. Six copies of the Factory Test data described below in 8-1/2 by 11 inch binders having a minimum of 3 rings from which material may readily be removed and replaced, including a separate section for each test. Separate sections by heavy plastic dividers with tabs. Provide full size (8-1/2 by 11 inch minimum) data plots showing grid lines, with full resolution.
 - (1) A detailed description of the procedures for factory tests.
 - (2) A list of equipment used, with calibration certifications.
 - (3) A copy of measurements taken, with required plots and graphs.
 - (4) The date of testing.
 - (5) A list of the parameters verified.
 - (6) The condition specified for the parameter.
 - (7) The test results, signed and dated.
 - (8) A description of adjustments made.

On engine-generator set tests where the engine and generator are required to be connected and operated together, the load power factor must be the power factor specified in the engine generator set parameter schedule power factor. Perform electrical measurements in accordance with IEEE 120. Temperature limits in the rating of electrical equipment and for the evaluation of electrical insulation must be in accordance with IEEE 1. In the following tests where measurements are to be recorded after stabilization of an engine-generator set parameter (voltage, frequency,

current, temperature, etc.), stabilization is considered to have occurred when measurements are maintained within the specified bandwidths or tolerances, for a minimum of four consecutive readings. Tests specifically for the generator may be performed utilizing any prime mover.

- a. Insulation Resistance for Stator and Exciter Test, IEEE 115 and IEEE 43, to the performance criteria in NEMA MG 1, Part 22. Generator manufacturer's production line test is acceptable.
- b. High Potential Test, in accordance with IEEE 115 and NEMA MG 1, test voltage in accordance with NEMA MG 1. Generator manufacturer's production line test is acceptable.
- c. Winding Resistance Test, Stator and Exciter, in accordance with IEEE 115. Generator manufacturer's production line test is acceptable.
- d. Phase Balance Voltage Test, to the performance criteria specified in paragraph GENERATOR. This test can be performed with any prime mover. Generator manufacturer's production line test results are acceptable.
 - (1) Start and operate the generator at no load.
 - (2) Adjust a regulated phase voltage (line-to-neutral) to rated voltage.
 - (3) Read and record the generator frequency, line-to-neutral voltages, and the line-to-line voltages.
 - (4) Apply 75 percent rated load and record the generator frequency, line-to-neutral voltages, and the line-to-line voltages.
 - (5) Apply rated load and record the generator frequency, line-to-neutral voltages, and the line-to-line voltages.
 - (6) Calculate average line-neutral voltage and percent deviation of individual line-neutral voltages from average for each load condition.
- e. Current Balance on Stator Winding Test, by measuring the current on each phase of the winding with the generator operating at 100 percent of Rated Output Capacity, with the load impedance equal for each of the three phases: to the performance criteria specified in paragraph GENERATOR.
- f. Voltage Waveform Deviation and Distortion Test in accordance with IEEE 115 to the performance criteria specified in paragraph GENERATOR. Use high-speed recording instruments capable of recording voltage waveform deviation and all distortion, including harmonic distortion. Include appropriate scales to provide a means to measure and interpret results.
- g. Voltage and Frequency Droop Test. Verify that the output voltage and frequency are within the specified parameters as follows:
 - (1) With the generator operating at no load, adjust voltage and frequency to rated voltage and frequency. Record the generator output frequency and line-line and line-neutral voltages.

- (2) Increase load to Rated Output Capacity. Record the generator output frequency and line-line and line-neutral voltages.
- (3) Calculate the percent droop for voltage and frequency with the following equations:

$$\text{Voltage droop percent} = \frac{(\text{No-Load Volts}) - (\text{Rated Capacity Volts})}{(\text{Service-Load Volts})} \times 100$$

$$\text{Frequency droop percent} = \frac{(\text{No-Load Hertz}) - (\text{Rated Capacity Hertz})}{(\text{Service-Load Hertz})} \times 100$$

- (4) Repeat steps 1 through 3 two additional times without making any adjustments.
- h. Frequency and Voltage Stability and Transient Response. Verify that the engine-generator set responds to addition and dropping of blocks of load in accordance with the transient response requirements. Document maximum voltage and frequency variation from bandwidth and verify that voltage and frequency return to and stabilize within the specified bandwidth, within the specified response time period. Document results in tabular form and with high resolution, high speed strip chart recorders or comparable digital recorders, as approved by the Contracting Officer. Include the following tabular data:
- (1) Ambient temperature (at 15 minute intervals).
 - (2) Generator output current (before and after load changes).
 - (3) Generator output voltage (before and after load changes).
 - (4) Frequency (before and after load changes).
 - (5) Generator output power (before and after load changes).
 - (6) Graphic representations must include the actual instrument trace of voltage and frequency showing: charts marked at start of test; observed steady-state band; mean of observed band; momentary overshoot and undershoot (generator terminal voltage and frequency) and recovery time for each load change together with the voltage and frequency maximum and minimum trace excursions for each steady state load condition prior to and immediately following each load change. Generator terminal voltage and frequency transient recovery time for each step load increase and decrease.
 - (a) Perform and record engine manufacturer's recommended pre-starting checks and inspections.
 - (b) Start the engine, make and record engine manufacturer's after-starting checks and inspections during a reasonable warm-up period and no load. Verify stabilization of voltage and frequency within specified bandwidths.
 - (c) With the unit at no load, apply the Maximum Step Load Increase.

- (d) Apply load in steps equal to the Maximum Step Load Increase until the addition of one more step increase will exceed the Service Load.
 - (e) Decrease load to the unit such that addition of the Maximum Step Load Increase will load the unit to 100 percent of Service Load.
 - (f) Apply the Maximum Step Load Increase.
 - (g) Decrease load to zero percent in steps equal to the Maximum Step Load Decrease.
 - (h) Repeat steps (c) through (g).
- j. Test Voltage Unbalance with Unbalanced Load (Line-to-Neutral) to the performance criteria specified in paragraph GENERATOR. Prototype test data is acceptable in lieu of the actual test. Submit manufacturer's standard certification that prototype tests were performed for the generator model proposed. This test may be performed using any prime mover.
- (1) Start and operate the generator set at rated voltage, no load, rated frequency, and under control of the voltage regulator. Read and record the generator frequency, line-to-neutral voltages, and the line-to-line voltages.
 - (2) Apply the specified load between terminals L_1-L_2 , L_2-L_0 , and L_3-L_0 in turn. Record all instrument readings at each line-neutral condition.
 - (3) Express the greatest difference between any two of the line-to-line voltages and any two of the line-to-neutral voltages as a percent of rated voltage.
 - (4) Compare the largest differences expressed in percent with the maximum allowable difference specified.

PART 3 EXECUTION

3.1 GENERAL INSTALLATION

Provide clear space for operation and maintenance in accordance with NFPA 70 and IEEE C2. Submit a copy of the manufacturer's installation procedures and a detailed description of the manufacturer's recommended break-in procedure. Install pipe, duct, conduit, and ancillary equipment to facilitate easy removal and replacement of major components and parts of the engine-generator set.

3.2 PIPING INSTALLATION

Weld piping. Provide flanged valve connections. Provide flanged connections at equipment. Provide threaded connections to the engine if the manufacturers standard connection is threaded. Except where otherwise specified, use welded flanged fittings to allow for complete dismantling and removal of each piping system from the facility without disconnecting or removing any portion of any other system's equipment or piping. Make connections to equipment with vibration isolation-type flexible

connectors. Support and align piping and tubing to prevent stressing of flexible hoses and connectors. Flash pipes extending through the roof. Install piping clear of windows, doors and openings, to permit thermal expansion and contraction without damage to joints or hangers, and install a 1/2 inch drain valve with cap at each low point.

The installation of gas engines must conform to the requirements of NFPA 37 and its references therein, including NFPA 54, NFPA 58, and ASME B31.3.

3.2.1 Flanged Joints

Provide flanges that are Class 125 type, drilled, and of the proper size and configuration to match the equipment and engine connections. Provide gasketed flanged joints that are square and tight.

3.2.2 Cleaning

After fabrication and before assembly, piping interiors must be manually wiped clean of debris.

3.3 ELECTRICAL INSTALLATION

Perform electrical installation in compliance with NFPA 70, IEEE C2, and Section 26 20 00 INTERIOR DISTRIBUTION SYSTEM. For vibration isolation, provide flexible fittings for conduit, cable trays, and raceways attached to engine-generator sets; provide flexible stranded conductor for metallic conductor cables installed on the engine generator set and from the engine generator set to equipment not mounted on the engine generator set; and provide crimp-type terminals or lugs for terminations of conductors on the engine generator set.

3.4 FIELD PAINTING

Perform field painting as specified in Section 09 90 00 PAINTS AND COATINGS.

3.5 ONSITE INSPECTION AND TESTS

Perform and report on factory tests and inspections prior to shipment. Provide certified copies of manufacturer's test data and results. Test procedures must conform to ASME, IEEE, [IEC,] and ANSI standards, and to ISO requirements on testing, as appropriate and applicable. The manufacturer performing the tests must provide equipment, labor, and consumables necessary for tests and measuring and indicating devices must be certified to be within calibration. Tests must indicate satisfactory operation and attainment of specified performance. If satisfactory, equipment tested will be given a tentative approval. Equipment must not be shipped before approval of the factory test reports for the following tests.

Submit a letter giving notice of the proposed dates of onsite inspections and tests at least 14 days prior to beginning tests.

- a. Submit a detailed description of the Contractor's procedures for onsite tests including the test plan and a listing of equipment necessary to perform the tests at least 30 days prior to beginning tests.
- b. Submit six copies of the onsite test data described below in 8-1/2 by

11 inch binders having a minimum of 3 rings from which material may readily be removed and replaced, including a separate section for each test. Separate sections by heavy plastic dividers with tabs. Provide full size (8-1/2 by 11 inch minimum) data plots showing grid lines, with full resolution.

- (1) A detailed description of the procedures for onsite tests.
- (2) A list of equipment used, with calibration certifications.
- (3) A copy of measurements taken, with required plots and graphs.
- (4) The date of testing.
- (5) A list of the parameters verified.
- (6) The condition specified for the parameter.
- (7) The test results, signed and dated.
- (8) A description of adjustments made.

3.5.1 Test Conditions

3.5.1.1 Data

Make and record measurements of all parameters necessary to verify that each set meets specified parameters. If the results of any test step are not satisfactory, make adjustments, replacements, or repairs and repeat the step until satisfactory results are obtained. Unless otherwise indicated, record data in 15 minute intervals during engine-generator set operation and include: readings of all engine-generator set meters and gauges for electrical and power parameters; oil pressure; ambient temperature; and engine temperatures available from meters and gauges supplied as permanent equipment on the engine-generator set. Perform electrical measurements in accordance with IEEE 120. Definitions of terms are in accordance with IEEE 100. Provide temperature limits in the rating of electrical equipment and for the evaluation of electrical insulations in accordance with IEEE 1.

3.5.1.2 Power Factor

Submit the generator capability curve showing generator kVA output capability (kW vs. kvar) for both leading and lagging power factors ranging from 0 to 1.0. For all engine-generator set operating tests the load power factor must be the power factor specified in the engine-generator set parameter schedule.

3.5.1.3 Contractor Supplied Items

Provide equipment and supplies required for inspections and tests including fuel, test instruments, and loadbanks at the specified power factors.

3.5.1.4 Instruments

Verify readings of panel gauges, meters, displays, and instruments provided as permanent equipment during test runs, using test instruments of greater precision and accuracy. Test instrument accuracy must be

within the following: current plus or minus 1.5 percent, voltage plus or minus 1.5 percent, real power plus or minus 1.5 percent, reactive power plus or minus 1.5 percent, power factor plus or minus 3 percent, frequency plus or minus 0.5 percent. Calibrate test instruments by a recognized standards laboratory within 30 days prior to testing.

3.5.1.5 Sequence

Provide the sequence of testing as specified in the approved testing plan unless variance is authorized by the Contracting Officer. Perform field testing in the presence of the Contracting Officer. Schedule and sequence tests in order to optimize run-time periods; however, follow the general order of testing: Construction Tests; Inspections; Pre-operational Tests; Safety Run Tests; Performance Tests; and Final Inspection.

3.5.2 Construction Tests

Perform individual component and equipment functional tests for fuel piping, coolant piping, and lubricating-oil piping, electrical circuit continuity, insulation resistance, circuit protective devices, and equipment not provided by the engine-generator set manufacturer prior to connection to the engine-generator set.

3.5.2.1 Piping Test

- a. Flush lube-oil and fuel-oil piping with the same type of fluid intended to flow through the piping, until the outflowing fluid has no obvious sediment or emulsion.
- b. Test fuel piping which is external to the engine-generator set in accordance with NFPA 30. Pressure all remaining piping which is external to the engine-generator set with air pressure at 150 percent of the maximum anticipated working pressure, but not less than 150 psi, for a period of 2 hours to prove the piping has no leaks. If piping is to be insulated, perform the test before the insulation is applied.

3.5.2.2 Electrical Equipment Tests

- a. Perform low-voltage cable insulation integrity tests for cables connecting the generator breaker to the automatic transfer switch. Test low-voltage cable, complete with splices, for insulation resistance after the cables are installed, in their final configuration, ready for connection to the equipment, and prior to energization. Apply a test voltage of 500 volts dc for one minute between each conductor and ground and between all possible combinations conductors in the same trench, duct, or cable, with all other conductors in the same trench, duct, or conduit. Provide the minimum value of insulation as follows:
 - (1) R in meg-ohms = (rated voltage in kV plus 1) x 304.8/(length of cable in meters)
 - (2) R in meg-ohms = (rated voltage in kV plus 1) x 1000/(length of cable in feet)
 - (3) Each cable failing this test must be repaired or replaced. The repair cable must be retested until failures have been eliminated.
- b. Ground-Resistance Tests. Measure the resistance of [each grounding

electrode] [each grounding electrode system] [the ground mat] [the ground ring] using the fall-of-potential method defined in IEEE 81. On systems consisting of interconnected ground rods, perform tests after interconnections are complete. Take measurements in normally dry weather, not less than 48 hours after rainfall. Provide site diagram indicating location of test probes with associated distances, and provide a plot of resistance vs. distance. The combined resistance of separate systems may be used to meet the requirements resistance, but the specified number of electrodes must still be provided as follows:

- (1) Multiple rod electrodes - 25 ohms.

c. Examine and test circuit breakers and switchgear in accordance with the manufacturer's published instructions for functional testing.

3.5.3 Inspections

Perform the following inspections jointly by the Contracting Officer and the Contractor, after complete installation of each engine-generator set and its associated equipment, and prior to startup of the engine-generator set. Submit a letter certifying that all facilities are complete and functional; that each system is fully functional; and that each item of equipment is complete, free from damage, adjusted, and ready for beneficial use. Perform checks applicable to the installation. Document and submit the results of those which are physical inspections (I) in accordance with paragraph SUBMITTALS. Present manufacturer's data for the inspections designated (D) at the time of inspection. Verify that equipment type, features, accessibility, installation and condition are in accordance with the contract specification. Provide manufacturer's statements to certify provision of features which cannot be verified visually.

Drive belts	I
Governor type and features	I
Engine timing mark	I
Starting motor	I
Starting aids	I
Coolant type and concentration	D
Radiator drains	I
Block coolant drains	I
Coolant fill level	I
Coolant line connections	I
Coolant hoses	I

Combustion air filter	I
Intake air silencer	I
Lube oil type	D
Lube oil sump drain	I
Lube-oil filter	I
Lube-oil level indicator	I
Lube-oil fill level	I
Lube-oil line connections	I
Lube-oil lines	I
Fuel type	D
Fuel level	I
Fuel-line connections	I
Fuel lines	I
Fuel filter	I
Access for maintenance	I
Voltage regulator	I
Battery-charger connections	I
Wiring and terminations	I
Instrumentation	I
Hazards to personnel	I
Base	I
Nameplates	I
Paint	I
Exhaust-heat system	I
Exhaust muffler	I
Switchboard	I
Switchgear	I

Access provided to controls	I
Enclosure is weather resistant	I
Engine and generator mounting bolts (application)	I

3.5.4 Engine Tests

Perform customary commercial factory tests in accordance with ISO 3046 on each engine and associated engine protective device, including, but not limited to the following:

- a. Perform dynamometer test at rated power. Record horsepower at rated speed and nominal characteristics such as lubricating oil pressure, jacket water temperature, and ambient temperature.
- b. Test and record the values that the low oil pressure alarm and protective shutdown devices actuate prior to assembly on the engine.
- c. Test and record values that the high jacket water temperature alarm and protective shutdown devices actuate prior to assembly on the engine.

3.5.5 Generator Tests

Tests must be performed on the complete factory assembled generator prior to shipment. Conduct tests in accordance with IEEE 115, IEC 60034-2A, and NEMA MG 1.

3.5.5.1 Routine Tests

Perform the following routine tests on the generators and their exciters:

- a. Resistance of armature and field windings.
- b. Mechanical balance.
- c. Phases sequence.
- d. Open circuit saturation curve and phase (voltage) balance test.
- e. Insulation resistance of armature and field windings.
- f. High potential test.

3.5.5.2 Design Tests

Submit the following design tests made on prototype machines that are physically and electrically identical to the generators specified.

- a. Temperature rise test
- b. Short circuit saturation curve and current balance test

3.5.6 Assembled Engine-Generator Set Tests

Submit the following tests made on prototype machines that are physically and electrically identical to the engine-generator set specified.

3.5.6.1 Initial Stabilization Readings

Operate the engine-generator set and allow the set to stabilize at rated kW at rated power factor, rated voltage, and rated frequency. During this period record instrument readings for output power (kW), terminal voltage, line current, power factor, frequency (rpm) generator (exciter) field voltage and current, lubricating oil pressure, jacket water temperature, and ambient temperature at minimum intervals of 15 minutes. Adjust the load, voltage, and frequency to maintain rated load at rated voltage and frequency. Adjustments to load, voltage, or frequency controls must be recorded on the data sheet at the time of adjustment. Stabilization must be considered to have occurred when four consecutive voltage and current recorded readings of the generator (or exciter) field either remain unchanged or have only minor variations about an equilibrium condition with no evident continued increase or decrease in value after the last adjustment to the load, voltage, or frequency has been made.

3.5.6.2 Regulator Range Test

Remove load and record instrument readings (after transients have subsided). Adjust voltage to the maximum attainable value or to a value just prior to actuation of the overvoltage protection device. Apply rated load and adjust voltage to the minimum attainable value or a value just prior to activation of the under-voltage protection device. The data sheets must indicate the voltage regulation as a percent of rated voltage and the maximum and minimum voltages attainable. Voltage regulation must be defined as follows:

$$\text{Percent Regulation} = \frac{((\text{No-Load Voltage}) - (\text{Rated-Load Voltage})) \times 100}{(\text{Rated-Load Voltage})}$$

3.5.6.3 Frequency Range Test

Adjust the engine-generator set frequency for the maximum attainable frequency at rated load. Record instrument readings. Adjust the engine-generator set frequency for the specified minimum attainable frequency at rated load. Record instrument readings. Reduce the load to zero and adjust the engine-generator set frequency for the maximum attainable frequency. Record instrument readings. Adjust the engine-generator set frequency for the minimum attainable frequency. Record instrument readings. The data sheet must show the maximum and minimum frequencies attained at rated load, and at no load.

3.5.6.4 Transient Response Test

Drop the load to no load and re-apply rated load three times to ensure that the no load and rated load voltage and frequency values are repeatable and that the frequency and voltage regulation is within the limits specified. Record generator terminal voltage and frequency using a high speed strip chart recorder. The data sheet must show the following results:

- a. Frequency

- (1) Stability bandwidth or deviation in percent of rated frequency.
- (2) Recovery time.
- (3) Overshoot and undershoot.

b. Voltage

- (1) Stability bandwidth or deviation in percent of rated voltage.
- (2) Recovery time.
- (3) Overshoot and undershoot.

3.5.7 Pre-operational Tests

3.5.7.1 Protective Relays

Visually and mechanically inspect, adjust, test, and calibrate protective relays in accordance with the manufacturer's published instructions. Include pick-up, timing, contact action, restraint, and other aspects necessary to ensure proper calibration and operation. Implement relay settings in accordance with the installation coordination study. Manually or electrically operate relay contacts to verify that the proper breakers and alarms initiate. Field test relaying current transformers in accordance with IEEE C57.13.1.

3.5.7.2 Insulation Test

Test generator and exciter circuits insulation resistance in accordance with IEEE 43. Take stator readings including generator leads to switchboard at the circuit breaker. Record results of insulation resistance tests. Readings must be within limits specified by the manufacturer. Verify mechanical operation, insulation resistance, protective relay calibration and operation, and wiring continuity of switchboard assembly. Do not damage generator components during test.

3.5.7.3 Engine-Generator Connection Coupling Test

When the generator provided is a two-bearing machine, inspect and check the engine-generator connection coupling by dial indicator to prove that no misalignment has occurred. Use the dial indicator to measure variation in radial positioning and axial clearance between the coupling halves. Take readings at four points, spaced 90 degrees apart. Align solid couplings and pin-type flexible couplings within a total indicator reading of 0.0005 to 0.001 inch for both parallel and angular misalignment. For gear-type or grid-type couplings, 0.002 inch will be acceptable.

3.5.8 Safety Run Test

For the following tests, repeat the associated safety tests if any parts are changed, or adjustments made to the generator set, its controls, or auxiliaries.

- a. Perform and record engine manufacturer's recommended prestarting checks and inspections.
- b. Start the engine, record the starting time, make and record engine

manufacturer's after-starting checks and inspections during a reasonable warm-up period.

- c. Activate the manual emergency stop switch and verify that the engine stops.
- d. Remove the high and pre-high lubricating oil temperature sensing elements from the engine and temporarily install a temperature gauge in their normal locations on the engine (required for safety, not for recorded data). Where necessary provide temporary wiring harness to connect the sensing elements to their permanent electrical leads.
- e. Start the engine, record the starting time, make and record engine manufacturer's after-starting checks and inspections during a reasonable warm-up period. Operate the engine-generator set at no load until the output voltage and frequency stabilize. Monitor the temporarily installed temperature gauges. If either temperature reading exceeds the value required for an alarm condition, activate the manual emergency stop switch.
- f. Immerse the elements in a vessel containing controlled-temperature hot oil and record the temperature at which the pre-high alarm activates and the temperature at which the engine shuts down. Remove the temporary temperature gauges and reinstall the temperature sensors on the engine.
- g. Remove the high and pre-high coolant temperature sensing elements from the engine and temporarily install a temperature gauge in their normal locations on the engine (required for safety, not for recorded data). Where necessary provide temporary wiring harness to connect the sensing elements to their permanent electrical leads.
- h. Start the engine, record the starting time, make and record engine manufacturer's after-starting checks and inspections during a reasonable warm-up period. Operate the engine generator-set at no load until the output voltage and frequency stabilize.
- i. Immerse the elements in a vessel containing controlled-temperature hot oil and record the temperature at which the pre-high alarm activates and the temperature at which the engine shuts down. Remove the temporary temperature gauges and reinstall the temperature sensors on the engine.
- j. Start the engine, record the starting time, make and record engine manufacturer's after-starting checks and inspections during a reasonable warm-up period.
- k. Operate the engine generator-set for at least 2 hours at 75 percent of Service Load.
- l. Verify proper operation and set-points of gauges and instruments.
- m. Verify proper operation of ancillary equipment.
- n. Manually adjust the governor to increase engine speed past the over-speed limit. Record the RPM at which the engine shuts down.
- o. Start the engine, record the starting time, make and record engine manufacturer's after-starting checks and inspections and operate the

engine generator-set for at least 15 minutes at 75 percent of Service Load.

- p. Manually adjust the governor to increase engine speed to within 2 percent of the over-speed trip speed previously determined and operate at that point for 5 minutes. Manually adjust the governor to the rated frequency.
- q. Manually fill the day tank to a level above the overflow limit. Record the level at which the overflow alarm sounds. Verify shutdown of the fuel transfer pump. Drain the day tank down below the overflow limit.
- r. Shut down the engine. Remove the time-delay low lube oil pressure alarm bypass and try to start the engine.
- s. Attach a manifold to the engine oil system (at the oil pressure sensor port) that contains a shutoff valve in series with a connection for the engine's oil pressure sensor followed by an oil pressure gauge ending with a bleed valve. Move the engine's oil pressure sensor from the engine to the manifold. Open the manifold shutoff valve and close the bleed valve.
- t. Start the engine, record the starting time, make and record engine manufacturer's after-starting checks and inspections and operate the engine generator-set for at least 15 minutes at 75 percent of Service Load.
- u. Close the manifold shutoff valve. Slowly allow the pressure in the manifold to bleed off through the bleed valve while watching the pressure gauge. Record the pressure at which the engine shuts down. Catch oil spillage from the bleed valve in a container. Add the oil from the container back to the engine, remove the manifold, and reinstall the engine's oil pressure sensor on the engine.
- v. Start the engine, record the starting time, make and record engine manufacturer's after-starting checks and inspections and operate the engine generator-set for at least 15 minutes at 100 percent of Service Load. Record the maximum sound level in each frequency band at a distance of 75 feet from the end of the exhaust and air intake piping directly along the path of intake and discharge for horizontal piping; or at a radius of 35 feet from the engine at 45 degrees apart in all directions for vertical piping. If a sound limiting enclosure is provided, modify or replace the enclosure, the muffler, and intake silencer must be modified or replaced as required to meet the sound requirements contained within this specification. If a sound limiting enclosure is not provided, the muffler and air intake silencer as required to meet the sound limitations of this specification. If the sound limitations cannot be obtained by modifying or replacing the muffler and air intake silencer, notify the Contracting Officers Representative and provide a recommendation for meeting the sound limitations.
- w. Manually drain off fuel slowly from the day tank to empty it to below the low fuel level limit and record the level at which the audible alarm sounds. Add fuel back to the day tank to fill it above low level alarm limits.

3.5.9 Performance Tests

In the following tests, where measurements are to be recorded after stabilization of an engine-generator set parameter (voltage, frequency, current, temperature, etc.), stabilization is considered to have occurred when measurements are maintained within the specified bandwidths or tolerances, for a minimum of four consecutive readings. For the following tests, repeat the associated tests if any parts are changed, or adjustments made to the generator set, its controls, or auxiliaries.

3.5.9.1 Continuous Engine Load Run Test

Test the engine-generator set and ancillary systems at service load to demonstrate durability; verify that heat of extended operation does not adversely affect or cause failure in any part of the system; and check all parts of the system. If the engine load run test is interrupted for any reason, repeat the entire test. Accomplish the engine load run test during daylight hours, with an average ambient temperature of 75 degrees F, during the month of April. After each change in load in the following test, measure the vibration at the end bearings (front and back of engine, outboard end of generator) in the horizontal, vertical, and axial directions. Verify that the vibration is within the allowable range. Take data taken at 15 minute intervals and include the following:

Electrical: Output amperes, voltage, real and reactive power, power factor, frequency.

Pressure: Lube-oil.

Temperature: Coolant, Lube-oil, Exhaust, Ambient.

- a. Perform and record engine manufacturer's recommended prestarting checks and inspections. Include as a minimum checking of coolant fluid, fuel, and lube-oil levels.
- b. Start the engine, make and record engine manufacturer's after-starting checks and inspections during a reasonable warmup period.
- c. Operate the engine generator-set for 2 hours at 75 percent of Service Load.
- d. Increase load to 100 percent of Service Load and operate the engine generator-set for 4 hours.
- e. For prime rated units, increase load to 110 percent of Service Load and operate the engine generator-set for 2 hours.
- f. Decrease load to 100 percent of Service Load and operate the engine generator-set for 2 hours or until all temperatures have stabilized.
- g. Remove load from the engine-generator set.

3.5.9.2 Voltage and Frequency Droop Test

For the following steps, verify that the output voltage and frequency return to and stabilize within the specified bandwidth values following each load change. Record the generator output frequency and line-line and line-neutral voltages following each load change.

- a. With the generator operating at no load, adjust voltage and frequency to rated voltage and frequency.
- b. Increase load to 100 percent of Rated Output Capacity. Record the generator output frequency and line-line and line-neutral voltages.
- c. Calculate the percent droop for voltage and frequency with the following equations.

$$\text{Voltage droop percent} = \frac{\text{No-load volts} - \text{rated output capacity volts}}{\text{Rated output capacity volts}} \times 100$$

$$\text{Frequency droop percent} = \frac{\text{No load hertz} - \text{rated output capacity hertz}}{\text{Rated output capacity volts}} \times 100$$

- d. Repeat steps a. through c. two additional times without making any adjustments.

3.5.9.3 Voltage Regulator Range Test

- a. While operating at no load, verify that the voltage regulator adjusts from 90 to 110 percent of rated voltage.
- b. Increase load to 100 percent of Rated Output Capacity. Verify that the voltage regulator adjusts from 90 to 110 percent of rated voltage.

3.5.9.4 Governor Adjustment Range Test

- a. While operating at no load, verify that the governor adjusts from 90 to 110 percent of rated frequency.
- b. Increase load to 100 percent of Rated Output Capacity. Verify that the governor adjusts from 90 to 110 percent of rated frequency.

3.5.9.5 Frequency and Voltage Stability and Transient Response

Verify that the engine-generator set responds to addition and dropping of blocks of load in accordance with the transient response requirements. Document maximum voltage and frequency variation from bandwidth and verify that voltage and frequency return to and stabilize within the specified bandwidth, within the specified response time period. Document results in tabular form and with high resolution, high speed strip chart recorders or comparable digital recorders, as approved by the Contracting Officer. Include the following tabular data:

- (1) Ambient temperature (at 15 minute intervals).
- (2) Generator output current (before and after load changes).
- (3) Generator output voltage (before and after load changes).
- (4) Frequency (before and after load changes).
- (5) Generator output power (before and after load changes).
- (6) Include the actual instrument trace of voltage and frequency in

graphic representations showing:

Charts marked at start of test; observed steady-state band; mean of observed band; momentary overshoot and undershoot (generator terminal voltage and frequency) and recovery time for each load change together with the voltage and frequency maximum and minimum trace excursions for each steady state load condition prior to and immediately following each load change. Generator terminal voltage and frequency transient recovery time for each step load increase and decrease.

- a. Perform and record engine manufacturer's recommended prestarting checks and inspections.
- b. Start the engine, make and record engine manufacturer's after-starting checks and inspections during a reasonable warm-up period and no load. Verify stabilization of voltage and frequency within specified bandwidths.
- c. With the unit at no load, apply the Maximum Step Load Increase.
- d. Apply load in steps equal to the Maximum Step Load Increase until the addition of one more step increase will exceed the Service Load.
- e. Decrease load to the unit such that addition of the Maximum Step Load Increase will load the unit to 100 percent of Service Load.
- f. Apply the Maximum Step Load Increase.
- g. Decrease load to zero percent in steps equal to the Maximum Step Load Decrease.
- h. Repeat steps c. through g.

3.5.10 Automatic Operation Tests

Test the automatic operating system to demonstrate automatic starting, the response to loss of operating engine-generator sets, and paralleling of each engine-generator set. Utilize load banks at the indicated power factor] [and actual loads to be served for this test, and the loading sequence is the indicated sequence. Record load-sharing characteristics during all operations. Perform this test for a minimum of two successive, successful tests. Include the following data:

- (1) Ambient temperature (at 15 minute intervals).
 - (2) Generator output current (before and after load changes).
 - (3) Generator output voltage (before and after load changes).
 - (4) Generator output frequency (before and after load changes).
 - (5) Power division and exchange between generator sets.
 - (6) Real and reactive power on each set.
- a. Initiate loss of the preferred power source and verify the specified sequence of operation.
 - b. Verify resetting of automatic starting and transfer logic.

3.6 GROUNDING

NFPA 70 and IEEE C2, except that grounding systems must have a resistance to solid earth ground not exceeding 5 ohms.

3.6.1 Grounding Electrodes

Provide driven ground rods as specified in Section 33 71 02 UNDERGROUND ELECTRICAL DISTRIBUTION. Connect ground conductors to the upper end of ground rods by exothermic weld or compression connector. Provide compression connectors at equipment end of ground conductors.

3.6.2 Engine-Generator Set Grounding

Provide separate copper grounding conductors and connect them to the ground system as indicated. When work in addition to that indicated or specified is required to obtain the specified ground resistance, the provision of the contract covering "Changes" must apply.

3.6.3 Connections

Make joints in grounding conductors by exothermic weld or compression connector. Exothermic welds and compression connectors must be installed as specified in Section 33 71 02 UNDERGROUND ELECTRICAL DISTRIBUTION paragraph regarding GROUNDING.

3.6.4 Grounding and Bonding Equipment

UL 467, except as indicated or specified otherwise.

3.7 START-UP ENGINEER

Provide the services of a qualified factory trained start-up engineer, regularly employed by the engine-generator set manufacturer. The start-up services must include conducting preliminary operations and functional acceptance tests. The start-up engineer must be present at the engine generator set installation-site, full-time, while preliminary operations and functional acceptance tests are being conducted.

3.8 PREREQUISITES FOR FUNCTIONAL ACCEPTANCE TESTING

Completion of the following requirements is mandatory prior to scheduling functional acceptance tests for the engine-generator set and auxiliary equipment.

3.8.1 Performance of Acceptance Checks and Tests

The acceptance checks and tests must be accomplished by the testing organization.

3.8.2 Generator Sets

Complete as specified in the paragraph ACCEPTANCE CHECKS AND TESTS.

3.8.2.1 Automatic Transfer Switches

Complete acceptance checks and tests as specified in Section 26 36 23 AUTOMATIC TRANSFER SWITCHES AND BY-PASS/ISOLATION SWITCH.

3.8.3 Preliminary Operations

The start-up engineer must conduct manufacturer recommended start-up procedures and tests to verify that the engine-generator set and auxiliary equipment are ready for functional acceptance tests. Give the Contracting Officer 15 days' advance notice that preliminary operations will be conducted. After preliminary operation has been successfully conducted, the start-up engineer will notify the Contracting Officer in writing stating the engine-generator set and auxiliary equipment are ready for functional acceptance tests.

3.8.4 Preliminary Assembled Operation and Maintenance Manuals

Preliminary assembled operation and maintenance manuals must have been submitted to and approved by the Contracting Officer. Manuals must be prepared as specified in the paragraph ASSEMBLED OPERATION AND MAINTENANCE MANUALS.

3.8.5 Functional Acceptance Test Procedure

Test procedure must be prepared by the start-up engineer specifically for the engine-generator set and auxiliary equipment. The test agenda must cover the requirements specified in the paragraph FUNCTIONAL ACCEPTANCE TESTS. The test procedure must indicate in detail how tests are to be conducted. A statement of the tests that are to be performed without indicating how the tests are to be performed is not acceptable. Indicate what work is planned on each workday and identify the calendar dates of the planned workdays. Specify what additional technical support personnel is needed such as factory representatives for major equipment. Specify on which testing workday each technical support personnel is needed. Data recording forms to be used to document test results are to be submitted with the proposed test procedure. A list of test equipment and instruments must also be included in the test procedure.

3.8.6 Test Equipment

Test equipment and instruments must be on hand prior to scheduling field tests or, subject to Contracting Officer approval, evidence must be provided to show that arrangements have been made to have the necessary equipment and instruments on-site prior to field testing.

3.9 FIELD QUALITY CONTROL

Give Contracting Officer 30 days' notice of dates and times scheduled for tests which require the presence of the Contracting Officer. The Contracting Officer will coordinate with the using activity and schedule a time that will eliminate or minimize interruptions and interference with the activity operations. The Contractor must be responsible for costs associated with conducting tests outside of normal working hours and with incorporating special arrangements and procedures, including temporary power conditions. The Contractor must provide labor, equipment, fuel, test load, and consumables required for the specified tests. The test load must be a cataloged product. Calibration of measuring devices and indicating devices must be certified. Refer to Section 26 20 00 INTERIOR DISTRIBUTION SYSTEM, for requirements for a cataloged product. Perform the following field tests.

3.9.1 Acceptance Checks and Tests

Perform in accordance with the manufacturer's recommendations, and include the following visual and mechanical inspections and electrical tests, performed in accordance with NETA ATS.

3.9.1.1 Circuit Breakers - Low Voltage Insulated Case/Molded Case

a. Visual and Mechanical Inspection

- (1) Compare nameplate data with specifications and approved shop drawings.
- (2) Inspect circuit breaker for correct mounting.
- (3) Operate circuit breaker to ensure smooth operation.
- (4) Inspect case for cracks or other defects.
- (5) Verify tightness of accessible bolted connections and cable connections by calibrated torque-wrench method. Thermo-graphic survey is not required.
- (6) Inspect mechanism contacts and arc chutes in unsealed units.

b. Electrical Tests

- (1) Perform contact-resistance tests.
- (2) Perform insulation-resistance tests.
- (3) Adjust breaker(s) for final settings in accordance with engine-generator set manufacturer's requirements.

3.9.1.2 Current Transformers

a. Visual and Mechanical Inspection

- (1) Compare equipment nameplate data with specifications and approved shop drawings.
- (2) Inspect physical and mechanical condition.
- (3) Verify correct connection.
- (4) Verify that adequate clearances exist between primary and secondary circuit.
- (5) Verify tightness of accessible bolted electrical connections by calibrated torque-wrench method. Thermo-graphic survey is not required.
- (6) Verify that all required grounding and shorting connections provide good contact.

b. Electrical Tests

- (1) Perform insulation-resistance tests.

- (2) Perform polarity tests.
- (3) Perform ratio-verification tests.

3.9.1.3 Metering and Instrumentation

a. Visual and Mechanical Inspection

- (1) Compare equipment nameplate data with specifications and approved shop drawings.
- (2) Inspect physical and mechanical condition.
- (3) Verify tightness of electrical connections.

b. Electrical Tests

- (1) Determine accuracy of meters at 25, 50, 75, and 100 percent of full scale.
- (2) Calibrate watt-hour meters according to manufacturer's published data.
- (3) Verify all instrument multipliers.
- (4) Electrically confirm that current transformer secondary circuits are intact.

3.9.1.4 Battery Systems

a. Visual and Mechanical Inspection

- (1) Compare equipment nameplate data with specifications and approved shop drawings.
- (2) Inspect physical and mechanical condition.
- (3) Verify tightness of accessible bolted electrical connections by calibrated torque-wrench method. Thermo-graphic survey is not required.
- (4) Measure electrolyte specific gravity and temperature and visually check fill level.
- (5) Verify adequacy of battery support racks, mounting, anchorage, and clearances.

b. Electrical Tests

- (1) Set charger float and equalizing voltage levels.
- (2) Verify all charger functions and alarms.
- (3) Measure each cell voltage and total battery voltage with charger energized and in float mode of operation.
- (4) Perform a capacity load test.

3.9.1.5 Engine-Generator Set

- a. Visual and Mechanical Inspection
 - (1) Compare equipment nameplate data with specifications and approved shop drawings.
 - (2) Inspect physical and mechanical condition.
 - (3) Inspect for correct anchorage and grounding.
- b. Electrical and Mechanical Tests
 - (1) Perform an insulation-resistance test on generator winding with respect to ground. Calculate polarization index.
 - (2) Perform phase rotation test to determine compatibility with load requirements.

3.9.1.6 Grounding System

- a. Visual and Mechanical Inspection
 - (1) Inspect ground system for compliance with contract plans and specifications.
- b. Electrical Tests
 - (1) Perform ground-impedance measurements utilizing the fall-of-potential method defined in IEEE 81. On systems consisting of interconnected ground rods, perform tests after interconnections are complete. Take measurements in normally dry weather, not less than 48 hours after rainfall. Provide site diagram indicating location of test probes with associated distances, and provide a plot of resistance vs. distance.

3.9.2 Functional Acceptance Tests

The tests must be performed by the start-up engineer. Upon successful test completion, the start-up engineer must provide the Contracting Officer with a written test report within 15 calendar days showing the tests performed and the results of each test. The report must include the completed approved test data forms and certification from the start-up engineer that the test results fall within the manufacturer's recommended limits and meet the specified requirements performance. The report must be dated and signed by the start-up engineer, and submitted for approval by the Contracting Officer. The Contracting Officer will witness final acceptance tests. Testing must include, but not be limited to, the following:

- a. Verify proper functioning of each engine protective shutdown device and pre-shutdown alarm device. Testing of the devices must be accomplished by simulating device actuation and observing proper alarm and engine shutdown operation.
- b. Verify proper functioning of the engine over-speed trip device. Testing of the over-speed trip device must be accomplished by raising the speed of the engine-generator set until an over-speed trip is experienced.

- c. Verify proper functioning of the crank cycle/terminate relay. Testing of the relay must be accomplished by engaging the starter motor with the engine being prevented from running. Observe the complete crank/rest cycle as described in the paragraph STARTING SYSTEM.
- d. Verify proper functioning of the following automatic and manual operations. Testing must include, but not be limited to, the following:
 - (1) Loss of Utility: Initiate a normal power failure with connected test load of rated kW at 1.0 power factor. Record time delay on start, cranking time until engine starts and runs, time to come up to operating speed, voltage and frequency overshoot, and time to achieve steady state conditions with all switches transferred to emergency position.
 - (2) Return of Utility: Return normal power and record time delay on retransfer for each automatic transfer switch, and time delay on engine cool-down and shutdown.
 - (3) Manual starting.
 - (4) Emergency stop.
- e. Operate the engine-generator set at rated current (amperes) until the jacket water temperature stabilizes. Stabilization will be considered to have occurred when three consecutive temperature readings remain unchanged. Continue to operate the generator set for an additional 2 hours. Record instrument readings for terminal voltage, line current, frequency (Hz), engine speed rpm, lubricating oil pressure, jacket water temperature, and ambient temperature at 5 minute intervals for first 15 minutes and at 15 minute intervals thereafter.

3.10 DEMONSTRATION

Upon completion of the work and at a time approved by the Contracting Officer, the Contractor must provide instructions by a qualified instructor to the Government personnel in the proper operation and maintenance of the equipment. Four Government personnel must receive training comparable to the equipment manufacturer's factory training. The duration of instruction must be for not less than one 8 hour working day for instruction of operating personnel and not less than one 8 hour working day for instruction of maintenance personnel.

3.10.1 Instructor's Qualification Resume

Instructors must be regular employees of the engine-generator set manufacturer. The instruction personnel provided to satisfy the requirements above must be factory certified by the related equipment manufacturer to provide instruction services. Submit the name and qualification resume of instructor to the Contracting Officer for approval.

3.10.2 Training Plan

Submit training plan 30 calendar days prior to training sessions. Training plan must include scheduling, content, outline, and training material (handouts). Content must include, but not be limited to, the following:

3.10.2.1 Operating Personnel Training

This instruction includes operating the engine-generator set, auxiliary equipment including automatic transfer switches in all modes, and the use of all functions and features specified.

3.10.2.2 Maintenance Personnel Training

Training must include mechanical, hydraulic, electrical, and electronic instructions for the engine-generator set and auxiliary equipment including automatic transfer switches.

a. Mechanical Training: Must include at least the following:

- (1) A review of mechanical diagrams and drawings.
- (2) Component location and functions.
- (3) Troubleshooting procedures and techniques.
- (4) Repair procedures.
- (5) Assembly/disassembly procedures.
- (6) Adjustments (how, when, and where).
- (7) Preventive maintenance procedures.
- (8) Review of flow diagram.
- (9) Valve locations and function.
- (10) Valve and hydraulic equipment adjustment and maintenance procedures.
- (11) Hydraulic system maintenance and servicing.
- (12) Lubrication points, type, and recommended procedures and frequency.

b. Electrical and Electronic Maintenance Training: Must include at least the following:

- (1) A review of electrical and electronic systems including wiring diagrams and drawings.
- (2) Troubleshooting procedures for the machine and control systems.
- (3) Electrical and electronic equipment servicing and care.
- (4) Use of diagnostics to locate the causes of malfunction.
- (5) Procedures for adjustments (locating components, adjustments to be made, values to be measured, and equipment required for making adjustments).
- (6) Maintenance and troubleshooting procedures for microprocessor or minicomputer where applicable.

- (7) Circuit board repair procedures where applicable (with schematics provided).
- (8) Use of diagnostic tapes.
- (9) Recommended maintenance servicing and repair for motors, switches, relays, solenoids, and other auxiliary equipment and devices.

3.11 ONSITE TRAINING

Conduct a training course for the operating staff as designated by the Contracting Officer. The training period must consist of a total 12 hours of normal working time and must start after the system is functionally completed but prior to final acceptance.

- a. Submit a letter giving the date proposed for conducting the onsite training course, the agenda of instruction, a description of the digital video recording to be provided. The course instructions must cover pertinent points involved in operating, starting, stopping, servicing the equipment, as well as major elements of the operation and maintenance manuals. Additionally, the course instructions must demonstrate routine maintenance procedures as described in the operation and maintenance manuals.
- b. Submit a digital video recording of the manufacturers operating and maintenance training course.
- c. One full size reproducible Mylar each drawing must accompany the booklets. Mylars must be rolled and placed in a heavy cardboard tube with threaded caps on each end. The manual must include step-by-step procedures for system startup, operation, and shutdown; drawings, diagrams, and single-line schematics to illustrate and define the electrical, mechanical, and hydraulic systems together with their controls, alarms, and safety systems; the manufacturer's name, model number, and a description of equipment in the system. The instructions must include procedures for interface and interaction with related systems to include automatic transfer switches, fire alarm/suppression systems and load shedding systems. Each booklet must include a CD containing an ASCII file of the procedures.
- d. Provide approved operation and maintenance manuals for the training course. Post approved instructions prior to the beginning date of the training course. Coordinate the training course schedule with the using service's work schedule, and submit for approval 14 days prior to beginning date of proposed beginning date of training.

3.12 INSTALLATION

Installation must conform to the applicable requirements of IEEE C2, NFPA 30, NFPA 37, and NFPA 70.

3.13 FINAL TESTING AND INSPECTION

- a. Start the engine, record the starting time, make and record all engine manufacturer's after-starting checks and inspections during a reasonable warm-up period.
- b. Increase the load in steps no greater than the Maximum Step Load

Increase to 100 percent of Service Load, and operate the engine-generator set for at least 30 minutes. Measure the vibration at the end bearings (front and back of engine, outboard end of generator) in the horizontal, vertical, and axial directions. Verify that the vibration is within the same range as previous measurements and is within the required range.

- c. Remove load and shut down the engine-generator set after the recommended cool down period.
- d. Remove the lube oil filter and have the oil and filter examined by the engine manufacturer for excessive metal, abrasive foreign particles, etc. Verify any corrective action for effectiveness by running the engine for 8 hours at Service Load, then re-examine the oil and filter.
- e. Remove the fuel filter and examine the filter for trash, abrasive foreign particles, etc.
- f. Visually inspect and check engine and generator mounting bolts for tightness and visible damage.
- g. Replace air, oil, and fuel filters with new filters.

3.14 MANUFACTURER'S FIELD SERVICE

The engine generator-set manufacturer must furnish a qualified representative to supervise the installation of the engine generator-set, assist in the performance of the onsite tests, and instruct personnel as to the operational and maintenance features of the equipment.

3.15 POSTED DATA AND INSTRUCTIONS

Post Data and Instructions prior to field acceptance testing of the engine generator set. [Provide two sets of instructions/data, typed and framed under weatherproof laminated plastic, and post side-by-side where directed. Include a one-line diagram, wiring and control diagrams and a complete layout of the system in the first set. Include the condensed operating instructions describing manufacturer's pre-start checklist and precautions; startup procedures for test-mode, manual-start mode, and automatic-start mode (as applicable); running checks, procedures, and precautions; and shutdown procedures, checks, and precautions in the second set. Submit posted data including wiring and control diagrams showing the key mechanical and electrical control elements, and a complete layout of the entire system.

- a. Include procedures for interrelated equipment (such as heat recovery systems, co-generation, load-shedding, and automatic transfer switches). Provide two sets of typed instructions/data in 8-1/2 x 11 inch format, laminated in weatherproof plastic, and placed in three-ring vinyl binders. Place the binders as directed by the Contracting Officer. Provide the instructions prior to acceptance of the engine generator set installation.
- b. Include a one-line diagram, wiring and control diagrams and a complete layout of the system in the first set. Include the condensed operating instructions describing manufacturer's pre-start checklist and precautions; startup procedures for test-mode, manual-start mode, and automatic-start mode (as applicable); running checks, procedures, and precautions; and shutdown procedures, checks, and precautions in

the second set. Include procedures for interrelated equipment (such as heat recovery systems, co-generation, load-shedding, and automatic transfer switches).

- c. Submit instructions including: the manufacturers pre-start checklist and precautions; startup procedures for test-mode, manual-start mode, and automatic-start mode (as applicable); running checks, procedures, and precautions; and shutdown procedures, checks, and precautions. Include procedures for interrelated equipment (such as heat recovery systems, co-generation, load-shedding, and automatic transfer switches). Provide weatherproof instructions, laminated in plastic, and post where directed.

3.16 ACCEPTANCE

Submit drawings which accurately depict the as-built configuration of the installation, upon acceptance of the engine-generator set installation. Revise layout drawings to reflect the as-built conditions and submit them with the as-built drawings. Final acceptance of the engine-generator set will not be given until the Contractor has successfully completed all tests and all defects in installation material or operation have been corrected.

-- End of Section --

SECTION 26 36 23

AUTOMATIC TRANSFER SWITCHES AND BY-PASS/ISOLATION SWITCH

PART 1 GENERAL

1.1 REFERENCES

The publications listed below form a part of this specification to the extent referenced. The publications are referred to within the text by the basic designation only.

ASTM INTERNATIONAL (ASTM)

ASTM D709 (2017) Standard Specification for Laminated Thermosetting Materials

INTERNATIONAL ELECTRICAL TESTING ASSOCIATION (NETA)

NETA ATS (2021) Standard for Acceptance Testing Specifications for Electrical Power Equipment and Systems

NATIONAL ELECTRICAL MANUFACTURERS ASSOCIATION (NEMA)

NEMA 250 (2020) Enclosures for Electrical Equipment (1000 Volts Maximum)

NEMA ICS 2 (2000; R 2020) Industrial Control and Systems Controllers, Contactors, and Overload Relays Rated 600 V

NEMA ICS 4 (2015) Application Guideline for Terminal Blocks

NEMA ICS 6 (1993; R 2016) Industrial Control and Systems: Enclosures

NATIONAL FIRE PROTECTION ASSOCIATION (NFPA)

NFPA 70 (2020; ERTA 20-1 2020; ERTA 20-2 2020; TIA 20-1; TIA 20-2; TIA 20-3; TIA 20-4) National Electrical Code

NFPA 110 (2016) Standard for Emergency and Standby Power Systems

UNDERWRITERS LABORATORIES (UL)

UL 508 (2018) UL Standard for Safety Industrial Control Equipment

UL 1008 (2014) Transfer Switch Equipment

UL 1066 (2012; Reprint Mar 2017) UL Standard for Safety Low-Voltage AC and DC Power Circuit

Breakers Used in Enclosures

1.2 RELATED REQUIREMENTS

Section 33 71 02 UNDERGROUND ELECTRICAL DISTRIBUTION applies to this section, with the additions and modifications specified herein.

1.3 SUBMITTALS

Government approval is required for submittals with a "G" classification. Submittals not having a "G" classification are for information only. When used, a code following the "G" classification identifies the office that will review the submittal for the Government. Submit the following in accordance with Section 01 33 00 SUBMITTAL PROCEDURES:

SD-02 Shop Drawings

Automatic Transfer Switch Drawings; G

SD-03 Product Data

Automatic Transfer Switches; G

By-Pass/Isolation Switch (BP/IS); G

SD-06 Test Reports

Acceptance Checks and Tests; G

Functional Acceptance Tests; G

Factory Testing; G

Factory Test Reports; G

SD-07 Certificates

Proof of Listing; G

1.4 OPERATION AND MAINTENANCE MANUAL

Assemble and bind manuals in durable, hard-covered, water resistant binders. Assemble and index the manuals per the following table of contents:

- a. Manufacturer's O&M per "SD-10 Operation and Maintenance Data".
- b. Catalog data required by "SD-03 Product Data"
- c. Drawings required by "SD-02 Shop Drawings".

1.4.1 Additions to Operation and Maintenance Manuals

In addition to requirements of SD-10 Data Package 5, include the followings on the actual equipment provided:

- a. An outline drawing, front, top, and side views.
- b. Prices for spare parts and supply list.

- c. Date of Purchase.
- d. Corrective maintenance procedures.
- e. Operating manual outlining step-by-step procedures for system startup, operation, and shutdown.
- f. Include simplified wiring and control diagrams in the manual for system as installed.
- g. Provide typical contact voltage drop readings under specified conditions for use during periodic maintenance. Provide instructions for determination of contact integrity.

1.4.2 Spare Parts

Furnish the following the following minimum spare parts and any other spare parts required in one-year operation, of the same material and workmanship, meeting the same requirements, and interchangeable with the corresponding original parts.

- a. Fuses: Two of each type and rating.

1.5 QUALITY ASSURANCE

1.5.1 Proof of Listing

Submit proof of listing by UL 1008.

1.5.2 Automatic Transfer Switch Drawings

Include the following as a minimum:

- a. An outline drawing, including front, top, and side views.
- b. Provide a nameplate of corrosion-resistant material with not less than 1/8 inch tall characters showing manufacturer's name and equipment ratings. Mount nameplate to front of enclosure and meet the nameplate requirements of NEMA ICS 2.
- c. Provide detail drawings that include manufacturer's name and catalog number, electrical ratings, total system transfer statement, reduced normal supply voltage at which transfer to the alternate supply is initiated, transfer delay times, short-circuit current rating, wiring diagram, description of interconnections, testing instructions, acceptable conductor type for terminals, tightening torque for each wire connector, and other required UL 1008 markings.
- d. Submit interface equipment connection diagram showing conduit and wiring between ATS and related equipment. Provide diagrams showing interlocking provisions and cautionary notes, if any.
- e. Drawings are to indicate adequate clearance for operation, maintenance, and replacement of operating equipment devices.

1.5.3 Regulatory Requirements

In each of the publications referred to herein, consider the advisory

provisions to be mandatory, as though the word "shall" or "must" had been substituted for "should" wherever it appears. Interpret references in these publications to the "authority having jurisdiction," or words of similar meaning, to mean the Contracting Officer. Equipment, materials, installation, and workmanship must be in accordance with the mandatory and advisory provisions of NFPA 70 unless more stringent requirements are specified or indicated

1.5.4 Standard Product

Provide materials and equipment that are products of manufacturers regularly engaged in the production of such products which are of equal material, design and workmanship, and:

- a. Have been in satisfactory commercial or industrial use for 2 years prior to bid opening including applications of equipment and materials under similar circumstances and of similar size.
- b. Have been on sale on the commercial market through advertisements, manufacturers' catalogs, or brochures during the 2-year period.
- c. Where two or more items of the same class of equipment are required, provide products of a single manufacturer; however, the component parts of the item need not be the products of the same manufacturer unless stated in this section.

1.5.4.1 Alternative Qualifications

Products having less than a 5-year field service record are acceptable if the manufacturer has been regularly engaged in the design and production of automatic transfer switches and if a certified record of satisfactory field operation for not less than 6000 hours, exclusive of the manufacturers' factory or laboratory tests, is furnished.

1.5.4.2 Material and Equipment Manufacturing Date

Products manufactured more than 1 years prior to date of delivery to site are not acceptable.

1.6 DELIVERY AND STORAGE

Protect equipment placed in storage from humidity and temperature variations, moisture, water intrusion, dirt, dust, or other contaminants. In harsh environments where temperatures exceed non-operational parameters established within this specification, provide an environmentally controlled equipment storage facility to ensure temperature parameters are within equipment specification. Provide documentation of same to the Government when storage is implemented.

1.7 ENVIRONMENTAL CONDITIONS

Provide an ATS that is suitable for prolonged performance under following service conditions:

- a. Operating altitude: Sea level to 1,000 ft.
- b. Operating ambient temperature range: 80 to 120 degrees F.
- c. Operating relative humidity: 0 to 90 percent, without condensation.

1.8 SEISMIC REQUIREMENTS

Provide seismic details[conforming to Section 26 05 48, SEISMIC PROTECTION FOR ELECTRICAL EQUIPMENT.

PART 2 PRODUCTS

2.1 AUTOMATIC TRANSFER SWITCHES

Each automatic transfer switch must be rated and marked for total system transfer and have the current and voltage ratings as indicated. Provide a switch operating mechanism that is electrically operated, have quick-make, quick-break, load break contacts, and be mechanically held in both positions. Switches utilizing circuit breakers are not acceptable. Provide an ATS that is UL listed. ATS must be manufactured and tested in accordance with applicable requirements of NEMA ICS 2, UL 1008 and UL 1066. ATS must conform to NFPA 110. Provide the ATS with the following characteristics:

- a. Voltage: volts ac as indicated.
- b. Amperage: amps ac as indicated. Provide an ATS with a continuous load current rating of the switch rating.
- c. Number of Phases: Three.
- d. Number of Wires: Four.
- e. Frequency: 60 Hz.
- f. Poles: Three switched. One of the poles is the neutral.
- g. ATS Withstand Current Rating: ATS must be rated to close on and withstand the available RMS symmetrical short circuit current at the ATS terminals. The ATS must be listed in accordance with UL 1008 for 3 cycle close and withstand ratings. Minimum UL listed close and withstand ratings at 208 VAC and 480 VAC must be 42 kA.
- h. Nonwelding Contacts: Provide contacts that are nonwelding at the available fault current rating. Contacts must be suitable for repetitive power transfer switching. Switches rated 800 amps and above must have segmented, blow-on construction for high withstand and close-on capability and be protected by separate arcing contacts.
- i. Phase Contacts: Provide contacts with silver alloy composition. Provide neutral contacts with the same continuous current rating as main or phase contacts.
- j. Configuration. Provide an ATS for use in optional standby systems described in NFPA 70.
- k. ATS Configuration. Provide a closed transition ATS.
- l. Service Entrance Rated. Provide an integrated circuit breaker and automatic transfer switch. Provide a separate deadfront compartment for the circuit breaker on switches 600 amp and larger. Provide label indicating that the ATS is the service disconnect. Provide a circuit breaker that is rated for 100 percent of the switch contact current

rating. All components, except as noted herein, are to have a continuous load rating.

- m. Viewing Ports. Provide contacts that are viewable from the front of the device when the door is open. Comply with the requirements found in IEEE 602 and NFPA 99.

2.1.1 Undervoltage Sensing - Normal/Preferred Source

Undervoltage Sensing - Normal Source. Provide undervoltage sensing for each phase in the normal/preferred source. Sense low phase-to-ground voltage on each phase. Provide sensing circuit with adjustable dropout, 75-98 percent of nominal value and adjustable pickup, 85-100 percent of nominal value. Factory set dropout value to 85 percent. Factory set pickup value to 90 percent.

2.1.2 Adjustable Time Delay - Override Transfer

Adjustable Time Delay - Override Transfer. For override of normal-source voltage sensing to delay transfer and engine starting signals. Engine starting control contacts with adjustable commit-to-start delay circuit, 0.0-6.0 seconds. Factory set at 1 second.

2.1.3 Adjustable Time Delay- Re-transfer to Normal/Preferred Source

Adjustable Time Delay- Transfer to Source. Re-transfer to normal source time delay, adjustable 0-30 minutes. Factory set at 10 minutes. Time delay is automatically defeated upon loss or sustained undervoltage of alternate power source, provided that normal source has been restored.

2.1.4 Engine-Generator Exerciser

Exerciser. Solid-state, programmable-time switch exerciser to allow automatic starting of the generator set, subsequent load transfer, retransfer of load and shuts down engine after a preset cool-down period. Initiates exercise cycle at preset intervals adjustable from on a daily, weekly, bi-weekly or monthly basis.. Running periods are adjustable from 10-30 minutes. Factory settings are for 7-day exercise cycle, 20 minute running period and 5-minute cool-down period. Exerciser features include the following:

- a. Exerciser Transfer Selector Switch: Permits selection of exercise with and without load transfer or dual independent exercisers that allow for unloaded and loaded schedule testing.
- b. Push-button programming control with digital display of settings.
- c. Integral battery operation of time switch when normal control power is not available.

2.1.5 Engine Shutdown Time Delay

Engine Shutdown. Provide time delay that is adjustable from 0 to 5 minutes and is factory set at 5 minutes.

2.1.6 Engine Starting Contacts

Provide 2 isolated normally closed and 2 isolated normally open contact that is rated 5 A at 250 VAC/30 VDC minimum.

2.1.7 Front Panel Devices

Provide devices mounted on cabinet front consisting of:

- a. Mode selector switch with the following positions and associated functions. Selector switch can be part of the microprocessor controller consisting of an LCD screen with a graphical interface or as a stand-alone test switch.
 - (1) TEST - Simulates loss of normal/preferred source system operation.
 - (2) NORMAL - Transfers system to normal/preferred source bypassing re-transfer time delay.
- b. Switch position indicating lights or graphical LCD display. Indicate source to which load is connected.
- c. Source-Available Monitor. Provide source-available indicating lights or graphical LCD display monitor that is labeled to show when one or both sources of power are available. If indicating lights are used, then the preference is to have Green be normal/preferred power and Red be for alternate/emergency power; however, other color schemes are allowed if clearly marked.
- d. Lamp test button.

2.2 BY-PASS/ISOLATION SWITCH (BP/IS)

Include non-load-break by-pass/isolation switches for the indicated automatic transfer switches. Designs which disconnect or interrupt the load when bypassing are not acceptable. Include the following features for each combined by-pass/isolation switch and automatic transfer switch:

- a. Bypass/isolation switch (BP/IS) and associated ATS are to be made by the same manufacturer and must be completely interconnected and tested at factory and at project site as specified.
- b. ATS is to be manufactured, listed and tested in accordance with paragraph AUTOMATIC TRANSFER SWITCH. BP/IS switch current, voltage, closing, and short-circuit withstand closing ratings are to be equal or exceed comparable ratings specified for ATS and have the same phase arrangement and number of poles.
- c. Provide externally operated and arranged selector switch or handle so designed and constructed not to stop in an intermediate or neutral position during operation and that one person can safely bypass the ATS. Accomplish isolation of the ATS externally by one person. Bypass and isolation handles must be permanently affixed and operable without opening the enclosure door. Provide interlocks that ensure ATS is disconnected from source and load during isolation. Interlocks prevent ATS operation, except for testing and maintenance, while isolated. BP/IS operation is to be accomplished without disconnecting switch load terminal conductors. Equipment which require separate tools, keys, or other devices to operate the bypass/isolation mechanism which may not be present during an emergency is not acceptable.
- d. Provide drawout transfer switch that provides physical separation from

bypass switch and live parts and accessibility for testing and maintenance operation.

- e. Provide contacts that have the same contact temperature that do not exceed those of the ATS contacts when carrying rated load. Provide contacts as specified for associated ATS, including provisions for inspection of contacts without disassembly of BP/IS or removal of entire contact enclosure. Provide manufacturer instructions for determining contact integrity in order To facilitate maintenance.
- f. The ATS controls remain functional with the ATS isolated or in bypass mode to permit monitoring of the normal power source [and automatic starting of the generator in the event of a loss of the normal power source]. In the isolated mode, the bypass section is capable of functioning as a manual transfer to transfer the load to either power source for maintenane purposes or when automatic control has failed. Equipment that requires automatic controls to be functional to operate the bypass switch is not acceptable.. The ATS can be completely removed from the enclosure, if required for maintenance or repair, while the bypass section continues to power the load.
- g. Construct Bypass/isolation switch for convenient removal of parts from front of switch enclosure without removal of other parts or disconnection of external power conductors.
- h. Achieve load by-pass to the source with no load interruption. Bypass/isolation equipment that breaks the load is not accpetalbe.
- i. Provide drawout bypass switch that provides physical separation from ATS and live parts and accessibility for testing and maintenance operation. Provide automatic shutters that closed to isolate the bus.
- j. Provide a means to ensure the switch is transferred to the alternate or emergency power source when normal power source becomes unavailable.

2.2.1 Markings

Mark isolation handle positions with engraved plates or other approved means to indicate position or operating condition of associated ATS, as follows:

- a. Provide an indication that shows that BP/IS section is providing power to the load.
- b. Provide indication of ATS isolation/test position.
- c. Provide suitable control labels and instruction signs describing operating instructions.
- d. Indicating lamps or LCD screen for indicating that shows the source availability, bypass switch position, transfer switch position, and isolation handle position. If indicating lights are used, provide a lamp test button that turns the indicating lights on, but does not cause any function to take place.

2.2.2 Interconnection

Interconnect BP/IS and associated ATS with suitably sized copper bus bars silver-plated at each connection point, and braced to withstand magnetic

and thermal forces created at withstand current rating specified for associated ATS.

2.3 ENCLOSURE

Provide an enclosure that meets the following:

- a. Provide ATS and accessories in a floor-mounted, wall-mounted, ventilated NEMA 250, Type 4X, smooth sheet metal enclosure constructed in accordance with applicable requirements of NEMA ICS 6, UL 508, UL 1066, and UL 1008. Provide screened and filtered intake vents. Provide screened exhaust vents. Provide door with suitable hinges, locking handle latch, and gasketed jamb. Provide at least No. 14 metal gauge.
- b. Factory wiring within enclosure and field wiring terminating within enclosure must comply with NFPA 70. Provide wire that is permanently tagged or marked near terminal at each end with wire number shown on approved detail drawing, when wiring is not color coded. Conform terminal block to NEMA ICS 4. Arrange terminals for entrance of external conductors from bottom of enclosure as shown. Main switch terminals, including neutral terminal if used, must be pressure type suitable for termination of external copper conductors shown.
- c. Provide thermostatically controlled heater within enclosure to prevent condensation over temperature range stipulated in paragraph SERVICE CONDITIONS.

2.3.1 Construction

Construct enclosure for ease of removal and replacement of ATS components and control devices from front without disconnection of external power conductors or removal or disassembly of major components.

2.3.2 Cleaning and Painting

Protect both the inside and outside surfaces of an enclosure, including means for fastening against corrosion by enameling, galvanizing, plating, powder coating, or other equivalent means. Protection is not required for metal parts that are inherently resistant to corrosion, bearings, sliding surfaces of hinges, or other parts where such protection is impractical. Provide manufacturer's standard finish material, process, and color that is free from runs, sags, peeling, or other defects. An enclosure marked Type 1, 3R, 4 or 12 is acceptable if there is no visible rust at the conclusion of a salt spray (fog) test using the test method in ASTM B117, employing a 5 percent by weight, salt solution for 24 hours. Type 4X enclosures are acceptable following performance of the above test with an exposure time of 200 hours.

2.3.3 Field Fabricated Nameplates

Nameplate is to comply with ASTM D709. Provide laminated plastic nameplates for each equipment enclosure as specified or as indicated on the drawings. Provide an inscription on each nameplate that identifies the name of the equipment, sources of power, calculated short circuit with date and the location e.g. 'SWB-1 Electrical Room 103'. Provide nameplates that are made of melamine plastic, 0.125 inch thick, white with black center core. Provide the nameplate with a surface that is matte finished and that has square corners. Accurately align lettering and

engrave into the core. Provide nameplates that are at least 1.0 by 2.5 inches with a minimum lettering size of 0.25 inch high normal block style.

2.4 REMOTE ANNUNCIATOR PANEL

Provide a remote annunciator panel that utilizes a touchscreen human machine interface (HMI). Minimum screen size is 7 inches. The annunciator is to be configured to handle 1 transfer switch. Provide a surface mounted cabinet. Provide built-in power supply that accepts either 24 VDC or 120VAC or 480. Provide communications module to support monitoring of ATS. Module shall provide status, analog parameters, event logs, equipment settings, and configurations over embedded webpage, open protocol, and automated email while utilizing AES 128-bit encryption. Provide a remote annunciation panel to annunciate the following conditions for the indicated transfer switch.

- a. Sources available
- b. Switch position.
- c. Switch in test mode.
- d. Failure of communication link.

2.5 FACTORY TESTING

Submit a description of proposed field test procedures, including proposed date and steps describing each test, its duration and expected results, not less than 4 weeks prior to test date. Submit certified factory and field test reports, within 14 days following completion of tests. Provide reports that are certified and dated and that demonstrate that tests were successfully completed prior to shipment of equipment.

2.5.1 Prototype Factory Testing

A prototype of specified ATS is to be factory tested in accordance with UL 1008. In addition, perform factory tests on each ATS as follows:

- a. Insulation resistance test to ensure integrity and continuity of entire system
- b. Main switch contact resistance test.
- c. Visual inspection to verify that each ATS is as specified.
- d. Mechanical test to verify that ATS sections are free of mechanical hindrances.
- e. Electrical tests to verify complete system electrical operation and to set up time delays and voltage sensing settings.

2.5.2 Factory Test Reports

Provide three certified copies of factory test reports from the manufacturer.

PART 3 EXECUTION

3.1 INSTALLATION

Installation must conform to the requirements of NFPA 70 and manufacturer's recommendation.

3.2 PREREQUISITES FOR FUNCTIONAL ACCEPTANCE TESTING

Completion of the following requirements is mandatory prior to scheduling functional acceptance tests for the automatic transfer switch.

3.2.1 Performance of Acceptance Checks and tests

Complete as specified in paragraph entitled "Acceptance Checks and Tests". The Acceptance Checks and Tests are to be accomplished by the Testing organization as described in Section 26 08 00 APPARATUS INSPECTION AND TESTING.

3.2.2 Manufacturers O&M Information

The manufacturers O&M information required by the paragraph entitled "SD-10 Operation and Maintenance Data", is to be submitted to and approved by the Contracting Officer.

3.2.3 Test Equipment

Ensure all test equipment and instruments is on hand prior to scheduling field tests, or subject to Contracting Officer's approval, evidence must be provided to show that arrangements have been made to have the necessary equipment and instruments on site prior to field testing.

3.3 FIELD QUALITY CONTROL

Give Contracting Officer 15 days notice of dates and times scheduled for tests which require the presence of the Contracting Officer. The Contracting Officer will coordinate with the using activity and schedule a time that will eliminate or minimize interruptions and interference with the activity operations. The contractor is responsible for costs associated with conducting tests outside of normal working hours and with incorporating special arrangements and procedures, including temporary power conditions. The contractor provides labor, equipment, apparatus, including test load, and consumables required for the specified tests. Calibration of all measuring devices and indicating devices must be certified. Provide the services of a qualified factory-trained manufacturer's representative to assist the contractor in installation and start-up of the equipment specified under this section. The manufacturer's representative is to provide technical direction and assistance to the contractor in general assembly of the equipment, connections and adjustments, and testing of the assembly components contained herein. Perform the following field tests in accordance with the manufacturer's recommendations and include the following visual and mechanical inspections and electrical tests, performed in accordance with NETA ATS.

3.3.1 Automatic Transfer Switch Acceptance Checks and Tests

a. Visual and Mechanical Inspection

- (1) Compare equipment nameplate data with specifications and approved shop drawings.
- (2) Inspect physical and mechanical condition.
- (3) Confirm correct application of manufacturer's recommended lubricants.
- (4) Verify that manual transfer warnings are attached and visible.
- (5) Verify tightness of all control connections.
- (6) Verify tightness of accessible bolted connections by calibrated torque-wrench method. Thermographic survey is not required.
- (7) Perform manual transfer operation.
- (8) Verify positive mechanical interlocking between normal and alternate sources.

b. Electrical Tests

- (1) Measure contact-resistance. Correct values that exceed 500 microhms and values for 1 pole deviating by more than 50 percent from other poles.
- (2) Perform insulation-resistance on each pole, phase-to-phase and phase-to-ground with switch closed, and across each open pole for one minute. Perform tests in both source positions.
- (3) Verify settings and operations of control devices.
- (4) Calibrate and set all relays and timers.
- (5) Test ground-fault protective device.

3.3.2 Functional Acceptance Tests

Functional Acceptance Tests must be coordinated with Section 26 32 15.00 ENGINE-GENERATOR SET STATIONARY 15-2500 KW, WITH AUXILIARIES. Include simulating power failure and demonstrating the following operations for each automatic transfer switch. Demonstrate in service that the automatic transfer switches are in good operating condition, and function not less than five times.

a. Perform automatic transfer tests:

- (1) Simulate loss of normal/preferred power.
- (2) Return to normal/preferred power.
- (3) Simulate loss of emergency/alternate power.
- (4) Simulate all forms of single-phase conditions.

b. Verify correct operation and timing of the following functions:

- (1) Normal source voltage-sensing relays.

- (2) Engine start sequence.
- (3) Time delay upon transfer.
- (4) Alternate source voltage-sensing relays.
- (5) Automatic transfer operation.
- (6) Interlocks and limit switch function.
- (7) Time delay and retransfer upon normal power restoration.
- (8) By-pass/isolation functional modes and related automatic transfer switch operations.

3.3.3 Infrared Scanning

After Substantial Completion, but not more than 60 days after Final Acceptance, perform an infrared scan of each switch. Remove all access panels so joints and connections are accessible to portable scanner.

- a. Follow-up Infrared Scanning: Perform an additional follow-up infrared scan of each switch 11 months after acceptance.
- b. Instrument: Use an infrared scanning device designed to measure temperature or to detect significant deviations from normal values. Provide calibration record for device.
- c. Record of Infrared Scanning: Prepare a certified report that identifies switches checked and that describes scanning results. Include notation of deficiencies detected, remedial action taken, and observations after remedial action.

3.4 TRAINING

Provide 4 hours of training to maintenance personnel on the proper operation, maintenance and adjustment of the automatic transfer switch. Coordinate this training with that of the generator equipment.

-- End of Section --

SECTION 31 23 00

EXCAVATION AND FILL

PART 1 GENERAL

1.1 REFERENCES

The publications listed below form a part of this specification to the extent referenced. The publications are referred to in the text by the basic designation only.

ASTM INTERNATIONAL (ASTM)

ASTM C136/C136M	(2019) Standard Test Method for Sieve Analysis of Fine and Coarse Aggregates
ASTM D698	(2012; E 2014; E 2015) Laboratory Compaction Characteristics of Soil Using Standard Effort (12,400 ft-lbf/cu. ft. (600 kN-m/cu. m.))
ASTM D1140	(2017) Standard Test Methods for Determining the Amount of Material Finer than 75- μ m (No. 200) Sieve in Soils by Washing
ASTM D1556/D1556M	(2015; E 2016) Standard Test Method for Density and Unit Weight of Soil in Place by Sand-Cone Method
ASTM D1557	(2012; E 2015) Standard Test Methods for Laboratory Compaction Characteristics of Soil Using Modified Effort (56,000 ft-lbf/ft ³) (2700 kN-m/m ³)
ASTM D2487	(2017; E 2020) Standard Practice for Classification of Soils for Engineering Purposes (Unified Soil Classification System)
ASTM D4318	(2017; E 2018) Standard Test Methods for Liquid Limit, Plastic Limit, and Plasticity Index of Soils
ASTM D6938	(2017a) Standard Test Method for In-Place Density and Water Content of Soil and Soil-Aggregate by Nuclear Methods (Shallow Depth)

U.S. ENVIRONMENTAL PROTECTION AGENCY (EPA)

EPA SW-846.3-3	(1999, Third Edition, Update III-A) Test Methods for Evaluating Solid Waste: Physical/Chemical Methods
----------------	--

1.2 DEFINITIONS

1.2.1 Capillary Water Barrier

A layer of clean, poorly graded crushed rock, stone, or natural sand or gravel having a high porosity which is placed beneath a building slab with or without a vapor barrier to cut off the capillary flow of pore water to the area immediately below a slab.

1.2.2 Degree of Compaction

Degree of compaction is expressed as a percentage of the maximum density obtained by the test procedure presented in ASTM D698 or ASTM D1557, for general soil types, abbreviated as percent laboratory maximum density.

1.2.3 Hard Materials

Weathered rock, dense consolidated deposits, or conglomerate materials which are not included in the definition of "rock" but which usually require the use of heavy excavation equipment, ripper teeth, or jack hammers for removal.

1.2.4 Rock

Solid homogeneous interlocking crystalline material with firmly cemented, laminated, or foliated masses or conglomerate deposits, neither of which can be removed without systematic drilling and blasting, drilling and the use of expansion jacks or feather wedges, or the use of backhoe-mounted pneumatic hole punchers or rock breakers; also large boulders, buried masonry, or concrete other than pavement exceeding 1/2 cubic yard in volume. Removal of hard material will not be considered rock excavation because of intermittent drilling and blasting that is performed merely to increase production.

1.2.5 Pile Supported Structure

As used herein, a structure where both the foundation and floor slab are pile supported.

1.3 SUBMITTALS

Government approval is required for submittals with a "G" classification. Submittals not having a "G" classification are for information only. When used, a code following the "G" classification identifies the office that will review the submittal for the Government. Submit the following in accordance with Section 01 33 00 SUBMITTAL PROCEDURES:

SD-01 Preconstruction Submittals

Shoring and Sheeting Plan

SD-06 Test Reports

Borrow Site Testing; G

Fill and backfill test

Select material test

Porous fill test for capillary water barrier

Density tests

Moisture Content Test

Copies of all laboratory and field test reports within 24 hours of the completion of the test.

1.4 DELIVERY, STORAGE, AND HANDLING

Perform in a manner to prevent contamination or segregation of materials.

1.5 CRITERIA FOR BIDDING

Base bids on the following criteria:

- a. Surface elevations are as indicated.
- b. Pipes or other artificial obstructions, except those indicated, will not be encountered.
- c. Suitable backfill and bedding material in the quantities required is not available at the project site on Government property.
- d. Blasting will not be permitted. Remove material in an approved manner.

1.6 REQUIREMENTS FOR OFF SITE SOIL

Soils brought in from off site for use as backfill shall be tested for petroleum hydrocarbons, BTEX, PCBs and HW characteristics (including toxicity, ignitability, corrosivity, and reactivity). Backfill shall not contain concentrations of these analytes above the appropriate State and/or EPA criteria, and shall pass the tests for HW characteristics. Determine petroleum hydrocarbon concentrations by using appropriate State protocols. Determine BTEX concentrations by using EPA SW-846.3-3 Method 5035/8260B. Perform complete TCLP in accordance with EPA SW-846.3-3 Method 1311. Perform HW characteristic tests for ignitability, corrosivity, and reactivity in accordance with accepted standard methods. Perform PCB testing in accordance with accepted standard methods for sampling and analysis of bulk solid samples. Provide borrow site testing for petroleum hydrocarbons and BTEX from a grab sample of material from the area most likely to be contaminated at the borrow site (as indicated by visual or olfactory evidence), with at least one test from each borrow site. For each borrow site, provide borrow site testing for HW characteristics from a composite sample of material, collected in accordance with standard soil sampling techniques. Do not bring material onsite until tests results have been received and approved by the Contracting Officer.

1.7 QUALITY ASSURANCE

1.7.1 Utilities

Movement of construction machinery and equipment over pipes and utilities during construction shall be at the Contractor's risk. Excavation made with power-driven equipment is not permitted within two feet of known Government-owned utility or subsurface construction. For work immediately adjacent to or for excavations exposing a utility or other buried

obstruction, excavate by hand. Start hand excavation on each side of the indicated obstruction and continue until the obstruction is uncovered or until clearance for the new grade is assured. Support uncovered lines or other existing work affected by the contract excavation until approval for backfill is granted by the Contracting Officer. Report damage to utility lines or subsurface construction immediately to the Contracting Officer.

PART 2 PRODUCTS

2.1 SOIL MATERIALS

2.1.1 Satisfactory Materials

Any materials classified by ASTM D2487 as GW, GP, GM, GP-GM, GW-GM, GC, GP-GC, GM-GC, SW, SP, SM, SW-SM, SP-SM, free of debris, roots, wood, scrap material, vegetation, refuse, soft unsound particles, and deleterious, or objectionable materials. Unless specified otherwise, the maximum particle diameter shall be one-half the lift thickness at the intended location.

2.1.2 Unsatisfactory Materials

Materials which do not comply with the requirements for satisfactory materials. Unsatisfactory materials also include man-made fills, trash, refuse, or backfills from previous construction. Unsatisfactory material also includes material classified as satisfactory which contains root and other organic matter. The Contracting Officer shall be notified of any contaminated materials.

2.1.3 Cohesionless and Cohesive Materials

Cohesionless materials include materials classified in ASTM D2487 as GW, GP, SW, and SP. Cohesive materials include materials classified as GC, SC, ML, CL, MH, and CH. Materials classified as GM, GP-GM, GW-GM, SW-SM, SP-SM, and SM shall be identified as cohesionless only when the fines are nonplastic (plasticity index equals zero). Materials classified as GM and SM will be identified as cohesive only when the fines have a plasticity index greater than zero.

2.1.4 Common Fill

Approved, unclassified soil material with the characteristics required to compact to the soil density specified for the intended location.

2.1.5 Backfill and Fill Material

ASTM D2487, classification GW, GP, GM, SW, SP, SM, with a maximum ASTM D4318 liquid limit of 35, maximum ASTM D4318 plasticity index of 10, and a maximum of 25 percent by weight passing ASTM D1140, No. 200 sieve.

2.1.6 Select Material

Provide materials classified as GW, GP, SW, SP, by ASTM D2487 where indicated. The liquid limit of such material shall not exceed 35 percent when tested in accordance with ASTM D4318. The plasticity index shall not be greater than 10 percent when tested in accordance with ASTM D4318, and not more than 35 percent by weight shall be finer than No. 200 sieve when tested in accordance with ASTM D1140.

2.2 BORROW

Obtain borrow materials required in excess of those furnished from excavations from sources outside of Government property.

2.3 BURIED WARNING AND IDENTIFICATION TAPE

Polyethylene plastic and metallic core or metallic-faced, acid- and alkali-resistant, polyethylene plastic warning tape manufactured specifically for warning and identification of buried utility lines. Provide tape on rolls, 3 inch minimum width, color coded as specified below for the intended utility with warning and identification imprinted in bold black letters continuously over the entire tape length. Warning and identification to read, "CAUTION, BURIED (intended service) LINE BELOW" or similar wording. Color and printing shall be permanent, unaffected by moisture or soil.

Warning Tape Color Codes	
Red:	Electric

2.3.1 Detectable Warning Tape for Non-Metallic Piping

Polyethylene plastic tape conforming to the width, color, and printing requirements specified above. Minimum thickness of the tape shall be 0.004 inch. Tape shall have a minimum strength of 1500 psi lengthwise and 1250 psi crosswise. Tape shall be manufactured with integral wires, foil backing, or other means of enabling detection by a metal detector when tape is buried up to 3 feet deep. Encase metallic element of the tape in a protective jacket or provide with other means of corrosion protection.

2.4 DETECTION WIRE FOR NON-METALLIC PIPING

Detection wire shall be insulated single strand, solid copper with a minimum of 12 AWG.

PART 3 EXECUTION

3.1 PROTECTION

3.1.1 Shoring and Sheeting

Provide shoring bracing as needed. Include provisions in the shoring and sheeting plan that will accomplish the following:

- a. Prevent undermining of pavements, foundations and slabs.
- b. Prevent slippage or movement in banks or slopes adjacent to the excavation.

3.1.2 Drainage and Dewatering

Provide for the collection and disposal of surface and subsurface water encountered during construction.

3.1.2.1 Drainage

So that construction operations progress successfully, completely drain

construction site during periods of construction to keep soil materials sufficiently dry. The Contractor shall establish/construct storm drainage features (ponds/basins) at the earliest stages of site development, and throughout construction grade the construction area to provide positive surface water runoff away from the construction activity and/or provide temporary ditches, swales, and other drainage features and equipment as required to maintain dry soils, prevent erosion and undermining of foundations. When unsuitable working platforms for equipment operation and unsuitable soil support for subsequent construction features develop, remove unsuitable material and provide new soil material as specified herein. It is the responsibility of the Contractor to assess the soil and ground water conditions presented by the plans and specifications and to employ necessary measures to permit construction to proceed. Excavated slopes and backfill surfaces shall be protected to prevent erosion and sloughing. Excavation shall be performed so that the site, the area immediately surrounding the site, and the area affecting operations at the site shall be continually and effectively drained.

3.1.3 Underground Utilities

Location of the existing utilities indicated is approximate. The Contractor shall physically verify the location and elevation of the existing utilities indicated prior to starting construction. The Contractor shall contact the Contracting Project Manager for assistance in locating existing utilities. The Contractor shall scan the construction site with electromagnetic and sonic equipment and mark the surface of the ground where existing underground utilities are discovered.

3.1.4 Machinery and Equipment

Movement of construction machinery and equipment over pipes during construction shall be at the Contractor's risk. Repair, or remove and provide new pipe for existing or newly installed pipe that has been displaced or damaged.

3.2 SURFACE PREPARATION

3.2.1 Clearing and Grubbing

Unless indicated otherwise, remove trees, stumps, logs, shrubs, brush and vegetation and other items that would interfere with construction operations within the clearing limits within lines 5 feet outside of each building and structure line. Remove stumps entirely. Grub out matted roots and roots over 2 inches in diameter to at least 18 inches below existing surface.

3.2.2 Stripping

Strip suitable soil from the site where excavation or grading is indicated and stockpile separately from other excavated material. Material unsuitable for use as topsoil shall be wasted. Locate topsoil so that the material can be used readily for the finished grading. Where sufficient existing topsoil conforming to the material requirements is not available on site, provide borrow materials suitable for use as topsoil. Protect topsoil and keep in segregated piles until needed.

3.2.3 Unsuitable Material

Remove vegetation, debris, decayed vegetable matter, sod, mulch, and

rubbish underneath paved areas or concrete slabs.

3.3 EXCAVATION

Excavate to contours, elevation, and dimensions indicated. Reuse excavated materials that meet the specified requirements for the material type required at the intended location. Keep excavations free from water. Excavate soil disturbed or weakened by Contractor's operations, soils softened or made unsuitable for subsequent construction due to exposure to weather. Excavations below indicated depths will not be permitted except to remove unsatisfactory material. Unsatisfactory material encountered below the grades shown shall be removed as directed. Refill with backfill and fill material or select material as indicated and compact to 95 percent of ASTM D1557 maximum density. Unless specified otherwise, refill excavations cut below indicated depth with backfill and fill material and compact to 95 percent of ASTM D1557 maximum density. Satisfactory material removed below the depths indicated, without specific direction of the Contracting Officer, shall be replaced with satisfactory materials to the indicated excavation grade; except as specified for spread footings. Determination of elevations and measurements of approved overdepth excavation of unsatisfactory material below grades indicated shall be done under the direction of the Contracting Officer.

3.3.1 Structures With Spread Footings

Ensure that footing subgrades have been inspected and approved by the Contracting Officer prior to concrete placement. Fill over excavations with concrete during foundation placement.

3.3.2 Excavated Materials

Satisfactory excavated material required for fill or backfill shall be placed in the proper section of the permanent work required or shall be separately stockpiled if it cannot be readily placed. Satisfactory material in excess of that required for the permanent work and all unsatisfactory material shall be disposed of as specified in Paragraph "DISPOSITION OF SURPLUS MATERIAL."

3.3.3 Final Grade of Surfaces to Support Concrete

Excavation to final grade shall not be made until just before concrete is to be placed. Only excavation methods that will leave the foundation rock in a solid and unshattered condition shall be used. Approximately level surfaces shall be roughened, and sloped surfaces shall be cut as indicated into rough steps or benches to provide a satisfactory bond. Shales shall be protected from slaking and all surfaces shall be protected from erosion resulting from ponding or flow of water.

3.4 SUBGRADE PREPARATION

Unsatisfactory material in surfaces to receive fill or in excavated areas shall be removed and replaced with satisfactory materials as directed by the Contracting Officer. The surface shall be scarified to a depth of 6 inches before the fill is started. Sloped surfaces steeper than 1 vertical to 4 horizontal shall be plowed, stepped, benched, or broken up so that the fill material will bond with the existing material. When subgrades are less than the specified density, the ground surface shall be broken up to a minimum depth of 6 inches, pulverized, and compacted to the specified density. When the subgrade is part fill and part excavation or

natural ground, the excavated or natural ground portion shall be scarified to a depth of 12 inches and compacted as specified for the adjacent fill. Material shall not be placed on surfaces that are muddy, frozen, or contain frost. Compaction shall be accomplished by sheepsfoot rollers, pneumatic-tired rollers, steel-wheeled rollers, or other approved equipment well suited to the soil being compacted. Material shall be moistened or aerated as necessary to provide the moisture content that will readily facilitate obtaining the specified compaction with the equipment used.

3.5 FILLING AND BACKFILLING

Fill and backfill to contours, elevations, and dimensions indicated. Compact each lift before placing overlaying lift.

3.5.1 Common Fill Placement

Provide for general site. Use satisfactory materials. Place in 6 inch lifts. Compact areas not accessible to rollers or compactors with mechanical hand tampers. Aerate material excessively moistened by rain to a satisfactory moisture content. Finish to a smooth surface by blading, rolling with a smooth roller, or both.

3.5.2 Backfill and Fill Material Placement

Provide for paved areas and under concrete slabs, except where select material is provided. Place in 8 inch maximum lifts. Do not place over wet or frozen areas. Place backfill material adjacent to structures as the structural elements are completed and accepted. Backfill against concrete only when approved. Place and compact material to avoid loading upon or against the structure.

3.5.3 Select Material Placement

Provide under structures not pile supported. Place in 8 inch maximum lifts. Do not place over wet or frozen areas. Backfill adjacent to structures shall be placed as structural elements are completed and accepted. Backfill against concrete only when approved. Place and compact material to avoid loading upon or against structure.

3.5.4 Backfill and Fill Material Placement Over Pipes and at Walls

Backfilling shall not begin until construction below finish grade has been approved, underground utilities systems have been inspected, tested and approved, forms removed, and the excavation cleaned of trash and debris. Backfill shall be brought to indicated finish grade. Where pipe is coated or wrapped for protection against corrosion, the backfill material up to an elevation 2 feet above sewer lines and 1 foot above other utility lines shall be free from stones larger than 1 inch in any dimension. Heavy equipment for spreading and compacting backfill shall not be operated closer to foundation or retaining walls than a distance equal to the height of backfill above the top of footing; the area remaining shall be compacted in layers not more than 4 inches in compacted thickness with power-driven hand tampers suitable for the material being compacted. Backfill shall be placed carefully around pipes or tanks to avoid damage to coatings, wrappings, or tanks. Backfill shall not be placed against foundation walls prior to 7 days after completion of the walls. As far as practicable, backfill shall be brought up evenly on each side of the wall and sloped to drain away from the wall.

3.5.5 Trench Backfilling

Backfill as rapidly as construction, testing, and acceptance of work permits. Place and compact backfill under structures and paved areas in 6 inch lifts to top of trench and in 6 inch lifts to one foot over pipe outside structures and paved areas.

3.6 BORROW

Where satisfactory materials are not available in sufficient quantity from required excavations, approved borrow materials shall be obtained as specified herein.

3.7 BURIED WARNING AND IDENTIFICATION TAPE

Provide buried utility lines with utility identification tape. Bury tape 12 inches below finished grade; under pavements and slabs, bury tape 6 inches below top of subgrade.

3.8 BURIED DETECTION WIRE

Bury detection wire directly above non-metallic piping at a distance not to exceed 12 inches above the top of pipe. The wire shall extend continuously and unbroken, from manhole to manhole. The ends of the wire shall terminate inside the manholes at each end of the pipe, with a minimum of 3 feet of wire, coiled, remaining accessible in each manhole. The wire shall remain insulated over its entire length. The wire shall enter manholes between the top of the corbel and the frame, and extend up through the chimney seal between the frame and the chimney seal. For force mains, the wire shall terminate in the valve pit at the pump station end of the pipe.

3.9 COMPACTION

Determine in-place density of existing subgrade; if required density exists, no compaction of existing subgrade will be required. Density requirements specified herein are for cohesionless materials. When cohesive materials are encountered or used, density requirements may be reduced by 5 percent.

3.9.1 General Site

Compact underneath areas designated for vegetation and areas outside the 5 foot line of the paved area or structure to 85 percent of ASTM D1557.

3.9.2 Structures, Spread Footings, and Concrete Slabs

Compact top 6 inches of subgrades to 90 percent of ASTM D1557. Compact select material to 95 percent of ASTM D1557.

3.9.3 Adjacent Area

Compact areas within 5 feet of structures to 90 percent of ASTM D1557.

3.9.4 Paved Areas

Compact top 6 inches of subgrades to 90 percent of ASTM D1557. Compact fill and backfill materials to 95 percent of ASTM D1557.

3.10 FINISH OPERATIONS

3.10.1 Grading

Finish grades as indicated within one-tenth of one foot. Grade areas to drain water away from structures. Maintain areas free of trash and debris. For existing grades that will remain but which were disturbed by Contractor's operations, grade as directed.

3.10.2 Protection of Surfaces

Protect newly backfilled, graded, and topsoiled areas from traffic, erosion, and settlements that may occur. Repair or reestablish damaged grades, elevations, or slopes.

3.11 DISPOSITION OF SURPLUS MATERIAL

Remove from Government property surplus or other soil material not required or suitable for filling or backfilling, and brush, refuse, stumps, roots, and timber.

3.12 FIELD QUALITY CONTROL

3.12.1 Sampling

Take the number and size of samples required to perform the following tests.

3.12.2 Testing

Perform one of each of the following tests for each material used. Provide additional tests for each source change.

3.12.2.1 Fill and Backfill Material Testing

Test fill and backfill material in accordance with ASTM C136/C136M for conformance to ASTM D2487 gradation limits; ASTM D1140 for material finer than the No. 200 sieve; ASTM D4318 for liquid limit and for plastic limit; ASTM D698 or ASTM D1557 for moisture density relations, as applicable.

3.12.2.2 Select Material Testing

Test select material in accordance with ASTM C136/C136M for conformance to ASTM D2487 gradation limits; ASTM D1140 for material finer than the No. 200 sieve; ASTM D698 or ASTM D1557 for moisture density relations, as applicable.

3.12.2.3 Density Tests

Test density in accordance with ASTM D1556/D1556M, or ASTM D6938. When ASTM D6938 density tests are used, verify density test results by performing an ASTM D1556/D1556M density test at a location already ASTM D6938 tested as specified herein. Perform an ASTM D1556/D1556M density test at the start of the job, and for every 10 ASTM D6938 density tests thereafter. Test each lift at randomly selected locations every 2000 square feet of existing grade in fills for structures and concrete slabs, and every 2500 square feet for other fill areas and every 2000 square feet of subgrade in cut. Include density test results in daily report.

Bedding and backfill in trenches: One test per 50 linear feet in each lift.

-- End of Section --

SECTION 32 11 23

AGGREGATE BASE COURSES

PART 1 GENERAL

1.1 REFERENCES

The publications listed below form a part of this specification to the extent referenced. The publications are referred to in the text by basic designation only.

AMERICAN ASSOCIATION OF STATE HIGHWAY AND TRANSPORTATION OFFICIALS
(AASHTO)

- AASHTO T 88 (2013) Standard Method of Test for Particle Size Analysis of Soils
- AASHTO T 180 (2017) Standard Method of Test for Moisture-Density Relations of Soils Using a 4.54-kg (10-lb) Rammer and a 457-mm (18-in.) Drop
- AASHTO T 224 (2010) Standard Method of Test for Correction for Coarse Particles in the Soil Compaction Test

ASTM INTERNATIONAL (ASTM)

- ASTM C29/C29M (2017a) Standard Test Method for Bulk Density ("Unit Weight") and Voids in Aggregate
- ASTM C88 (2018) Standard Test Method for Soundness of Aggregates by Use of Sodium Sulfate or Magnesium Sulfate
- ASTM C117 (2017) Standard Test Method for Materials Finer than 75-um (No. 200) Sieve in Mineral Aggregates by Washing
- ASTM C127 (2015) Standard Test Method for Density, Relative Density (Specific Gravity), and Absorption of Coarse Aggregate
- ASTM C128 (2015) Standard Test Method for Density, Relative Density (Specific Gravity), and Absorption of Fine Aggregate
- ASTM C131/C131M (2020) Standard Test Method for Resistance to Degradation of Small-Size Coarse Aggregate by Abrasion and Impact in the Los Angeles Machine
- ASTM C136/C136M (2019) Standard Test Method for Sieve Analysis of Fine and Coarse Aggregates

ASTM D75/D75M	(2019) Standard Practice for Sampling Aggregates
ASTM D1556/D1556M	(2015; E 2016) Standard Test Method for Density and Unit Weight of Soil in Place by Sand-Cone Method
ASTM D1557	(2012; E 2015) Standard Test Methods for Laboratory Compaction Characteristics of Soil Using Modified Effort (56,000 ft-lbf/ft ³) (2700 kN-m/m ³)
ASTM D2167	(2015) Density and Unit Weight of Soil in Place by the Rubber Balloon Method
ASTM D2487	(2017; E 2020) Standard Practice for Classification of Soils for Engineering Purposes (Unified Soil Classification System)
ASTM D4318	(2017; E 2018) Standard Test Methods for Liquid Limit, Plastic Limit, and Plasticity Index of Soils
ASTM D5821	(2013; R 2017) Standard Test Method for Determining the Percentage of Fractured Particles in Coarse Aggregate
ASTM D6938	(2017a) Standard Test Method for In-Place Density and Water Content of Soil and Soil-Aggregate by Nuclear Methods (Shallow Depth)
ASTM E11	(2020) Standard Specification for Woven Wire Test Sieve Cloth and Test Sieves

1.2 DEFINITIONS

For the purposes of this specification, the following definitions apply.

1.2.1 Aggregate Base Course

Aggregate base course (ABC) is well graded, durable aggregate uniformly moistened and mechanically stabilized by compaction.

1.2.2 Graded-Crushed Aggregate Base Course

Graded-crushed aggregate (GCA) base course is well graded, crushed, durable aggregate uniformly moistened and mechanically stabilized by compaction.

1.2.3 Degree of Compaction

Degree of compaction required, except as noted in the second sentence, is expressed as a percentage of the maximum laboratory dry density obtained by the test procedure presented in ASTM D1557 abbreviated as a percent of laboratory maximum dry density. Since ASTM D1557 applies only to soils that have 30 percent or less by weight of their particles retained on the

3/4 inch sieve, the degree of compaction for material having more than 30 percent by weight of their particles retained on the 3/4 inch sieve will be expressed as a percentage of the laboratory maximum dry density in accordance with AASHTO T 180 Method D and corrected with AASHTO T 224.

1.3 SUBMITTALS

Government approval is required for submittals with a "G" classification. Submittals not having a "G" classification are for information only. When used, a code following the "G" classification identifies the office that will review the submittal for the Government. Submit the following in accordance with Section 01 33 00 SUBMITTAL PROCEDURES:

SD-06 Test Reports

Initial Tests; G
In-Place Tests; G

1.4 EQUIPMENT, TOOLS, AND MACHINES

All plant, equipment, and tools used in the performance of the work will be subject to approval by the Contracting Officer before the work is started. Maintain all plant, equipment, and tools in satisfactory working condition at all times. Submit a list of proposed equipment, including descriptive data. Use equipment capable of minimizing segregation, producing the required compaction, meeting grade controls, thickness control, and smoothness requirements as set forth herein.

1.5 QUALITY ASSURANCE

Sampling and testing are the responsibility of the Contractor. Perform sampling and testing using a laboratory approved in accordance with Section 01 45 00.10 20 QUALITY CONTROL. Work requiring testing will not be permitted until the testing laboratory has been inspected and approved. Test the materials to establish compliance with the specified requirements and perform testing at the specified frequency. The Contracting Officer may specify the time and location of the tests. Furnish copies of test results to the Contracting Officer within 24 hours of completion of the tests.

1.5.1 Sampling

Take samples for laboratory testing in conformance with ASTM D75/D75M. When deemed necessary, the sampling will be observed by the Contracting Officer.

1.5.2 Tests

1.5.2.1 Sieve Analysis

Perform sieve analysis in conformance with ASTM C117 and ASTM C136/C136M using sieves conforming to ASTM E11.

1.5.2.2 Liquid Limit and Plasticity Index

Determine liquid limit and plasticity index in accordance with ASTM D4318.

1.5.2.3 Moisture-Density Determinations

Determine the laboratory maximum dry density and optimum moisture content in accordance with paragraph DEGREE OF COMPACTION.

1.5.2.4 Field Density Tests

Measure field density in accordance with ASTM D1556/D1556M, ASTM D2167 or ASTM D6938. For the method presented in ASTM D1556/D1556M use the base plate as shown in the drawing. For the method presented in ASTM D6938 check the calibration curves and adjust them, if necessary, using only the sand cone method as described in paragraph Calibration, of the ASTM publication. Tests performed in accordance with ASTM D6938 result in a wet unit weight of soil and ASTM D6938 will be used to determine the moisture content of the soil. Also check the calibration curves furnished with the moisture gauges along with density calibration checks as described in ASTM D6938. Make the calibration checks of both the density and moisture gauges using the prepared containers of material method, as described in paragraph Calibration of ASTM D6938, on each different type of material being tested at the beginning of a job and at intervals as directed. Submit calibration curves and related test results prior to using the device or equipment being calibrated.

1.5.2.5 Wear Test

Perform wear tests on ABC and GCA course material in conformance with ASTM C131/C131M.

1.5.2.6 Soundness

Perform soundness tests on GCA in accordance with ASTM C88.

1.5.2.7 Weight of Slag

Determine weight per cubic foot of slag in accordance with ASTM C29/C29M on the ABC and GCA course material.

1.6 ENVIRONMENTAL REQUIREMENTS

Perform construction when the atmospheric temperature is above 35 degrees F. When the temperature falls below 35 degrees F, protect all completed areas by approved methods against detrimental effects of freezing. Correct completed areas damaged by freezing, rainfall, or other weather conditions to meet specified requirements.

PART 2 PRODUCTS

2.1 AGGREGATES

Provide ABC and GCA consisting of clean, sound, durable particles of crushed stone, crushed gravel, angular sand, or other approved material. Provide ABC that is free of lumps of clay, organic matter, and other objectionable materials or coatings. Provide GCA that is free of silt and clay as defined by ASTM D2487, organic matter, and other objectionable materials or coatings. The portion retained on the No. 4 sieve is known as coarse aggregate; that portion passing the No. 4 sieve is known as fine aggregate. When the coarse and fine aggregate is supplied from more than one source, provide aggregate from each source that meets the specified requirements.

2.1.1 Coarse Aggregate

Provide coarse aggregates with angular particles of uniform density. Separately stockpile coarse aggregate supplied from more than one source.

- a. Crushed Gravel: Provide crushed gravel that has been manufactured by crushing gravels and that meets all the requirements specified below.
- b. Crushed Stone: Provide crushed stone consisting of freshly mined quarry rock, meeting all the requirements specified below.

2.1.1.1 Aggregate Base Course

The percentage of loss of ABC coarse aggregate must not exceed 50 percent when tested in accordance with ASTM C131/C131M. Provide aggregate that contains no more than 30 percent flat and elongated particles. A flat particle is one having a ratio of width to thickness greater than 3; an elongated particle is one having a ratio of length to width greater than 3. In the portion retained on each sieve specified, the crushed aggregates must contain at least 50 percent by weight of crushed pieces having two or more freshly fractured faces determined in accordance with ASTM D5821. When two fractures are contiguous, the angle between planes of the fractures must be at least 30 degrees in order to count as two fractured faces. Manufacture crushed gravel from gravel particles 50 percent of which, by weight, are retained on the maximum size sieve listed in TABLE 1.

2.1.1.2 Graded-Crushed Aggregate Base Course

The percentage of loss of GCA coarse aggregate must not exceed 40 percent loss when tested in accordance with ASTM C131/C131M. Provide GCA coarse aggregate that does not exhibit a loss greater than 18 percent weighted average, at five cycles, when tested for soundness in magnesium sulfate, or 12 percent weighted average, at five cycles, when tested in sodium sulfate in accordance with ASTM C88. Provide aggregate that contains no more than 20 percent flat and elongated particles for the fraction retained on the 1/2 inch sieve nor 20 percent for the fraction passing the 1/2 inch sieve. A flat particle is one having a ratio of width to thickness greater than 3; an elongated particle is one having a ratio of length to width greater than 3. In the portion retained on each sieve specified, the crushed aggregate must contain at least 90 percent by weight of crushed pieces having two or more freshly fractured faces determined in accordance with ASTM D5821. When two fractures are contiguous, the angle between planes of the fractures must be at least 30 degrees in order to count as two fractured faces. Manufacture crushed gravel from gravel particles 90 percent of which by weight are retained on the maximum size sieve listed in TABLE 1.

2.1.2 Fine Aggregate

Provide fine aggregates consisting of angular particles of uniform density.

2.1.2.1 Aggregate Base Course

Provide ABC fine aggregate that consists of screenings, angular sand, crushed recycled concrete fines, or other finely divided mineral matter processed or naturally combined with the coarse aggregate.

2.1.2.2 Graded-Crushed Aggregate Base Course

Provide GCA fine aggregate consisting of angular particles produced by crushing stone, slag, or gravel that meets the requirements for wear and soundness specified for GCA coarse aggregate. Produce fine aggregate by crushing only particles larger than No. 4 sieve in size. Provide fine aggregate that contains at least 90 percent by weight of particles having two or more freshly fractured faces in the portion passing the No. 4 sieve and retained on the No. 10 sieve, and in the portion passing the No. 10 sieve and retained on the No. 40 sieve.

2.1.3 Gradation Requirements

Apply the specified gradation requirements to the completed base course. Provide aggregates that are continuously well graded within the limits specified in TABLE 1. Use sieves that conform to ASTM E11.

TABLE 1. GRADATION OF AGGREGATES

Percentage by Weight Passing Square-Mesh Sieve

Sieve Designation	No. 1	No. 2	No. 3
2 inch	100	----	----
1-1/2 inch	70-100	100	----
1 inch	45-80	60-100	100
1/2 inch	30-60	30-65	40-70
No. 4	20-50	20-50	20-50
No. 10	15-40	15-40	15-40
No. 40	5-25	5-25	5-25
No. 200	0-8	0-8	0-8

NOTE 1: Particles having diameters less than 0.02 mm must not be in excess of 3 percent by weight of the total sample tested as determined in accordance with AASHTO T 88.

NOTE 2: The values are based on aggregates of uniform specific gravity. If materials from different sources are used for the coarse and fine aggregates, test the materials in accordance with ASTM C127 and ASTM C128 to determine their specific gravities. Correct the percentages passing the various sieves as directed by the Contracting Officer if the specific gravities vary by more than 10 percent.

2.2 LIQUID LIMIT AND PLASTICITY INDEX

Apply liquid limit and plasticity index requirements to the completed course and to any component that is blended to meet the required gradation. The portion of any component or of the completed course passing the No. 40 sieve must be either nonplastic or have a liquid limit not greater than 25 and a plasticity index not greater than 5.

2.3 TESTS, INSPECTIONS, AND VERIFICATIONS

2.3.1 Initial Tests

Perform one of each of the following tests, on the proposed material prior

to commencing construction, to demonstrate that the proposed material meets all specified requirements when furnished. Complete this testing for each source if materials from more than one source are proposed.

- a. Sieve Analysis.
- b. Liquid limit and plasticity index.
- c. Moisture-density relationship.
- d. Wear.

Submit certified copies of test results for approval not less than 30 days before material is required for the work.

2.3.2 Approval of Material

Tentative approval of material will be based on initial test results.

PART 3 EXECUTION

3.1 GENERAL REQUIREMENTS

When the ABC or GCA is constructed in more than one layer, clean the previously constructed layer of loose and foreign matter by sweeping with power sweepers or power brooms, except that hand brooms may be used in areas where power cleaning is not practicable. Provide adequate drainage during the entire period of construction to prevent water from collecting or standing on the working area.

3.2 OPERATION OF AGGREGATE SOURCES

Clearing, stripping, and excavating are the responsibility of the Contractor. Condition aggregate sources on Government property to readily drain and leave in a satisfactory condition upon completion of the work.

3.3 STOCKPILING MATERIAL

Clear and level storage sites prior to stockpiling of material. Stockpile all materials, including approved material available from excavation and grading, in the manner and at the locations designated. Stockpile aggregates on the cleared and leveled areas designated by the Contracting Officer to prevent segregation. Stockpile materials obtained from different sources separately.

3.4 PREPARATION OF UNDERLYING COURSE OR SUBGRADE

Clean the underlying course or subgrade of all foreign substances prior to constructing the base course(s). Do not construct base course(s) on underlying course or subgrade that is frozen. Construct the surface of the underlying course or subgrade to meet specified compaction and surface tolerances. Correct ruts or soft yielding spots in the underlying courses, areas having inadequate compaction, and deviations of the surface from the specified requirements set forth herein by loosening and removing soft or unsatisfactory material and adding approved material, reshaping to line and grade, and recompacting to specified density requirements. For cohesionless underlying courses or subgrades containing sands or gravels, as defined in ASTM D2487, stabilize the surface prior to placement of the base course(s). Stabilize by mixing ABC or GCA into the underlying course

and compacting by approved methods. Consider the stabilized material as part of the underlying course and meet all requirements of the underlying course. Do not allow traffic or other operations to disturb the finished underlying course and maintain in a satisfactory condition until the base course is placed.

3.5 GRADE CONTROL

Provide a finished and completed base course conforming to the lines, grades, and cross sections shown. Place line and grade stakes as necessary for control.

3.6 MIXING AND PLACING MATERIALS

Mix the coarse and fine aggregates in a stationary plant, or in a traveling plant or bucket loader on an approved paved working area. Make adjustments in mixing procedures or in equipment, as directed, to obtain true grades, to minimize segregation or degradation, to obtain the required water content, and to insure a satisfactory base course meeting all requirements of this specification. Place the mixed material on the prepared subgrade or subbase in layers of uniform thickness with an approved spreader. Place the layers so that when compacted they will be true to the grades or levels required with the least possible surface disturbance. Where the base course is placed in more than one layer, clean the previously constructed layers of loose and foreign matter by sweeping with power sweepers, power brooms, or hand brooms, as directed. Make adjustments in placing procedures or equipment as may be directed by the Contracting Officer to obtain true grades, to minimize segregation and degradation, to adjust the water content, and to insure an acceptable base course.

3.7 LAYER THICKNESS

Compact the completed base course to the thickness indicated. No individual layer may be thicker than 8 inches nor be thinner than 3 inches in compacted thickness. Compact the base course(s) to a total thickness that is within 1/2 inch of the thickness indicated. Where the measured thickness is more than 1/2 inch deficient, correct such areas by scarifying, adding new material of proper gradation, reblading, and recompacting as directed. Where the measured thickness is more than 1/2 inch thicker than indicated, the course will be considered as conforming to the specified thickness requirements. The average job thickness will be the average of all thickness measurements taken for the job and must be within 1/4 inch of the thickness indicated. Measure the total thickness of the base course at intervals of one measurement for each 500 square yards of base course. Measure total thickness using 3 inch diameter test holes penetrating the base course.

3.8 COMPACTION

Compact each layer of the base course, as specified, with approved compaction equipment. Maintain water content during the compaction procedure to within plus or minus 2 percent of the optimum water content determined from laboratory tests as specified in this Section. Begin rolling at the outside edge of the surface and proceed to the center, overlapping on successive trips at least one-half the width of the roller. Slightly vary the length of alternate trips of the roller. Adjust speed of the roller as needed so that displacement of the aggregate does not occur. Compact mixture with hand-operated power tampers in all

places not accessible to the rollers. Continue compaction until each layer is compacted through the full depth to at least 95 percent of laboratory maximum density. Make such adjustments in compacting or finishing procedures as may be directed by the Contracting Officer to obtain true grades, to minimize segregation and degradation, to reduce or increase water content, and to ensure a satisfactory base course. Remove any materials found to be unsatisfactory and replace with satisfactory material or rework, as directed, to meet the requirements of this specification.

3.9 EDGES OF BASE COURSE

Place approved material along the outer edges of the base course in sufficient quantity to compact to the thickness of the course being constructed. When the course is being constructed in two or more layers, simultaneously roll and compact at least a 2 foot width of this shoulder material with the rolling and compacting of each layer of the base course, as directed.

3.10 FINISHING

Finish the surface of the top layer of base course after final compaction by cutting any overbuild to grade and rolling with a steel-wheeled roller. Do not add thin layers of material to the top layer of base course to meet grade. If the elevation of the top layer of base course is 1/2 inch or more below grade, scarify the top layer to a depth of at least 3 inches and blend new material in and compact to bring to grade. Make adjustments to rolling and finishing procedures as directed by the Contracting Officer to minimize segregation and degradation, obtain grades, maintain moisture content, and insure an acceptable base course. Should the surface become rough, corrugated, uneven in texture, or traffic marked prior to completion, scarify the unsatisfactory portion and rework and recompact it or replace as directed.

3.11 SMOOTHNESS TEST

Construct the top layer so that the surface shows no deviations in excess of 3/8 inch when tested with a 12 foot straightedge. Take measurements in successive positions parallel to the centerline of the area to be paved. Also take measurements perpendicular to the centerline at 50 foot intervals. Correct deviations exceeding this amount by removing material and replacing with new material, or by reworking existing material and compacting it to meet these specifications.

3.12 FIELD QUALITY CONTROL

3.12.1 In-Place Tests

Perform each of the following tests on samples taken from the placed and compacted ABC and GCA. Take samples and test at the rates indicated.

- a. Perform density tests on every lift of material placed and at a frequency of one set of tests for every 250 square yards, or portion thereof, of completed area.
- b. Perform sieve analysis on every lift of material placed and at a frequency of one sieve analysis for every 500 square yards, or portion thereof, of material placed.

- c. Perform liquid limit and plasticity index tests at the same frequency as the sieve analysis.
- d. Measure the thickness of the base course at intervals providing at least one measurement for each 500 square yards of base course or part thereof. Measure the thickness using test holes, at least 3 inch in diameter through the base course.

3.12.2 Approval of Material

Final approval of the materials will be based on tests for gradation, liquid limit, and plasticity index performed on samples taken from the completed and fully compacted course(s).

3.13 TRAFFIC

Do not allow traffic on the completed base course.

3.14 MAINTENANCE

Maintain the base course in a satisfactory condition until the full pavement section is completed and accepted. Immediately repair any defects and repeat repairs as often as necessary to keep the area intact. Retest any base course that was not paved over prior to the onset of winter to verify that it still complies with the requirements of this specification. Rework or replace any area of base course that is damaged as necessary to comply with this specification.

3.15 DISPOSAL OF UNSATISFACTORY MATERIALS

Dispose of any unsuitable materials that have been removed outside the limits of Government-controlled land or as directed. No additional payments will be made for materials that have to be replaced.

-- End of Section --

SECTION 32 31 13

CHAIN LINK FENCES AND GATES

PART 1 GENERAL

1.1 REFERENCES

The publications listed below form a part of this specification to the extent referenced. The publications are referred to within the text by the basic designation only.

ASTM INTERNATIONAL (ASTM)

ASTM A90/A90M	(2021) Standard Test Method for Weight [Mass] of Coating on Iron and Steel Articles with Zinc or Zinc-Alloy Coatings
ASTM A116	(2011) Standard Specification for Metallic-Coated, Steel Woven Wire Fence Fabric
ASTM A153/A153M	(2016a) Standard Specification for Zinc Coating (Hot-Dip) on Iron and Steel Hardware
ASTM A702	(2013) Standard Specification for Steel Fence Posts and Assemblies, Hot Wrought
ASTM A780/A780M	(2020) Standard Practice for Repair of Damaged and Uncoated Areas of Hot-Dip Galvanized Coatings
ASTM F567	(2014a) Standard Practice for Installation of Chain Link Fence
ASTM F626	(2014) Standard Specification for Fence Fittings
ASTM F1043	(2018) Standard Specification for Strength and Protective Coatings on Steel Industrial Fence Framework
ASTM F1083	(2018) Standard Specification for Pipe, Steel, Hot-Dipped Zinc Coated (Galvanized) Welded, for Fence Structures

U.S. GENERAL SERVICES ADMINISTRATION (GSA)

FS RR-F-191/2	(Rev E) Fencing, Wire and Post, Metal (Chain-Link Fence Gates)
FS RR-F-191/3	(Rev E; Am 1) Fencing, Wire and Post, Metal (Chain-Link Fence Posts, Top Rails and Braces)

1.2 SUBMITTALS

Government approval is required for submittals with a "G" classification. Submittals not having a "G" classification are for information only. When used, a code following the "G" classification identifies the office that will review the submittal for the Government. Submit the following in accordance with Section 01 33 00 SUBMITTAL PROCEDURES:

SD-02 Shop Drawings

Fence Assembly; G

Location of Gate, Corner, End, and Pull Posts; G

Gate Assembly; G

Gate Hardware and Accessories; GErection/Installation Drawings; G

SD-03 Product Data

Fence Assembly; G

Gate Assembly; G

Gate Hardware and Accessories; G

Zinc Coating; G

Fabric; G

Stretcher Bars; G

SD-07 Certificates

Certificates of Compliance

SD-08 Manufacturer's Instructions

Fence Assembly

Gate Assembly

Hardware Assembly

Accessories

1.3 QUALITY CONTROL

1.3.1 Certificates of Compliance

Submit certificates of compliance in accordance with the applicable reference standards and descriptions of this section for the following:

- a. Zinc coating
- b. Fabric
- c. Stretcher bars

d. Gate hardware and accessories

1.4 DELIVERY, STORAGE, AND HANDLING

Deliver materials to site in an undamaged condition. Store materials off the ground to provide protection against oxidation caused by ground contact.

PART 2 PRODUCTS

2.1 SYSTEM DESCRIPTION

Provide fencing materials conforming to the requirements of ASTM A116, ASTM A702, ASTM F626.

Submit reports of listing chain-link fencing and accessories regarding weight in ounces for zinc coating.

Submit manufacturer's catalog data for complete fence assembly, gate assembly, hardware assembly and accessories.

2.2 COMPONENTS

2.2.1 Fabric

Provide fabric consisting of No. 9-gage wires woven into a 2 inch diamond mesh, with dimensions of fabric and wire conforming to ASTM A116, with 2.0 ounces per square foot zinc galvanizing.

Provide one-piece fabric widths for fence heights up to 3 feet.

2.2.1.1 Top and Bottom Selvages

Provide knuckled selvages at top and bottom for fabric with 2 inch mesh and up to 60 inches high, and if over 60 inches high, provide twisted and barbed top selvaqe and knuckled bottom selvaqe.

Knuckle top and bottom selvages for 1-3/4 inch and 1 inch mesh fabric.

2.2.2 Line Posts

Minimum acceptable line posts are as follows:

Up to 6 feet high:

Grade A: 1.900 inch O.D. pipe weighing 2.72 pounds per linear foot.

Over 6 feet high:

2.0 inch O.D. pipe weighing 3.65 pounds per linear foot.

2.2.3 End, Corner, and Pull Posts

Provide minimally acceptable end, corner, and pull posts as follows:

Up to 6 feet high:

Grade A: 2.375 inch O.D. pipe weighing 3.65 pounds per linear foot.

Over 6 feet high:

Grade A: 2.875 inch O.D. pipe weighing 5.79 pounds per linear foot.

2.2.4 Top Rail

Provide top rails with a minimum of 1.660 inches O.D. pipe rails. Grade A weighing 2.27 pounds per linear foot. Provide expansion couplings 6 inches long at each joint in top rails.

2.2.5 Post-Brace Assembly

Provide bracing consisting of 1.660 inches O.D. pipe Grade A weighing 2.27 pounds per linear foot and 3/8 inch adjustable truss rods and turnbuckles.

2.2.6 Stretcher Bars

Provide bars that have one-piece lengths equal to the full height of the fabric with a minimum cross section of 3/16 by 3/4 inch, in accordance with ASTM F626.

2.2.7 Stretcher Bar Bands

Provide bar bands for securing stretcher bars to posts that are steel, wrought iron, or malleable iron spaced not over 15 inches on center. Bands may also be used in conjunction with special fittings for securing rails to posts. Provide bands with projecting edges chamfered or eased.

2.2.8 Post Tops

Provide tops that are steel, wrought iron, or malleable iron designed as a weathertight closure cap. Provide one cap for each post, unless equal protection is provided by a combination post-cap and wire supporting arm. Provide caps with an opening to permit through passage of the top rail.

2.2.9 Gate Posts

Provide a gate post for supporting each gate leaf as follows:

Up to 6-feet wide:

2.875 inch O.D. pipe Grade A weighing 5.79 pounds per linear foot.

2.2.10 Gates

FS RR-F-191/2; Type [I, single swing] [II, double swing] [III, single cantilever sliding, wheel sliding gate] [IV, double cantilever sliding] [V, single overhead sliding] [VI, double overhead sliding] [VII, vertical lift] [VIII, special]. Shape and size of gate frame, [as indicated] [_____]. Framing and bracing members, [round][square] of [steel][aluminum] alloy. [Steel member finish, [zinc-coated] [or] [PVC-coated over zinc- or aluminum-coated steel].] Provide gate frames and braces of minimum sizes listed in FS RR-F-191/3 for each Class and Grade, except that steel pipe frames are a minimum of 1.90 inches o.d., 0.120 inches minimum wall thickness and aluminum pipe frames and intermediate braces are 1.869 inches o.d. minimum, 0.940 lb/ft of length. Gate fabric, is as specified for fencing fabric. Coating for steel latches, stops, hinges, keepers, and accessories, is [galvanized] [PVC,

minimum thickness of 0.01 inch.] Provide [fork] [plunger bar] type gate latches. [Special gate frames, [as indicated] [_____].] [Provide intermediate members as necessary for gate leaves more than 8 feet wide, to provide rigid construction, free from sag or twist.] [Provide truss rods or intermediate braces for gate leaves less than 8 feet wide.] Attach gate fabric to gate frame in accordance with manufacturer's standards, except that welding is not permitted. Arrange padlocking latches to be accessible from both sides of gate, regardless of latching arrangement.

For gate leaves up to 6 feet high or 6 feet wide, provide perimeter gate frames of 1.66 inch O.D. pipe Grade A weighing 2.27 pounds per linear foot.

Provide gate frame assembly that is welded or assembled with special malleable or pressed-steel fittings and rivets to provide rigid connections. Install fabric with stretcher bars at vertical edges; stretcher bars may also be used at top and bottom edges. Attach stretcher bars and fabric to gate frames on all sides at intervals not exceeding 15 inches. Attach hardware with rivets or by other means which provides equal security against breakage or removal.

Provide diagonal cross-bracing, consisting of 3/8 inch diameter adjustable-length truss rods on welded gate frames, where necessary to obtain frame rigidity without sag or twist. Provide nonwelded gate frames with diagonal bracing.

2.2.11 Gate Hardware and Accessories

Provide gate hardware and accessories that conforms to ASTM A116 and ASTM F626, and be as specified:

Provide forged steel hinges to suit gate size, non-lift-off type, offset to permit 180-degree opening.

Provide latch that permits operation from either side of the gate, with a padlock eye provided as an integral part of the latch.

2.2.12 Miscellaneous Hardware

Provide miscellaneous hot-dip galvanized hardware as required.

2.2.13 Wire Ties

Provide 9-gage galvanized steel wire for tying fabric to line posts, spaced 12 inches on center. For tying fabric to rails and braces, space wire ties 24 inches on center. For tying fabric to tension wire, space 0.105-inch hog rings 24 inches on center.

Manufacturer's standard procedure will be accepted if of equal strength and durability.

Provide wire ties constructed of the same material as the fencing fabric.

2.3 MATERIALS

2.3.1 Zinc Coating

Provide hot-dip galvanized (after fabrication) ferrous-metal components and accessories, except as otherwise specified.

Provide zinc coating of weight not less than 1.94 ounces per square foot, as determined from the average result of two specimens, when tested in accordance with ASTM A90/A90M.

Provide zinc coating conforming to the requirements of the following:

- a. Pipe: FS RR-F-191/3 Class 1 Grade A in accordance with ASTM F1083.
- b. Hardware and accessories: ASTM A153/A153M, Table 1
- c. Surface: ASTM F1043
- d. External: Type B-B surface zinc with organic coating, 0.97 ounce per square foot minimum thickness of acrylated polymer.
- e. Internal: Surface zinc coating of 0.97 ounce per square foot minimum.

Provide galvanizing repair material that is cold-applied zinc-rich coating conforming to ASTM A780/A780M.

2.3.2 Tension Wire

Provide galvanized, coiled spring wire, No. 7-gage. Provide zinc coating that weighs not less than 2.0 ounces per square foot.

2.3.3 Grout

Provide grout of proportions one part portland cement to three parts clean, well-graded sand and a minimum amount of water to produce a workable mix.

PART 3 EXECUTION

Submit manufacturer's erection/installation drawings and instructions that detail proper assembly and materials in the design for fence, gate, hardware and accessories.

Provide complete installation conforming to ASTM F567.

3.1 PREPARATION

Ensure final grading and established elevations are complete prior to commencing fence installation.

3.2 INSTALLATION

3.2.1 Fence Installation

Install fence on prepared surfaces to line and grade indicated. Secure fastening and hinge hardware in place to fence framework by peening or welding. Allow for proper operation of components. Coat peened or welded areas with a repair coating matching original coating. Install fence in accordance with fence manufacturer's written installation instructions except as modified herein.

3.2.1.1 Post Spacing

Provide line posts spaced equidistantly apart, not exceeding 6 feet on

center. Provide gate posts spaced as necessary for size of gate openings. Do not exceed 500 feet on straight runs between braced posts. Provide corner or pull posts, with bracing in both directions, for changes in direction of 15 degrees or more, or for abrupt changes in grade. Submit drawings showing location of gate, corner, end, and pull posts.

3.2.1.2 Top and Bottom Tension Wire

Install bottom tension wires before installing chain-link fabric, and pull wires taut. Place top and bottom tension wires within 8 inches of respective fabric line.

3.2.2 Setting Posts

Remove loose and foreign materials from holes prior to placing concrete.

Provide tops of footings that are trowel finished and sloped or domed to shed water away from posts. Set hold-open devices, sleeves, and other accessories in concrete.

Keep exposed concrete moist for at least 7 calendar days after placement or cured with a membrane curing material, as approved.

Maintain vertical alignment of posts in concrete construction until concrete has set.

3.2.2.1 Bracing

Brace gate, corner, end, and pull posts to nearest post with a horizontal brace used as a compression member, placed at least 12 inches below top of fence, and a diagonal tension rod.

a. Tolerances

Provide posts that are straight and plumb within a vertical tolerance of 1/4 inch after the fabric has been stretched. Provide fencing and gates that are true to line with no more than 1/2 inch deviation from the established centerline between line posts. Repair defects as directed.

3.2.3 Concrete Strength

Provide concrete that has attained at least 75 percent of its minimum 28-day compressive strength, but in no case sooner than 7 calendar days after placement, before rails, tension wire, or fabric are installed. Do not stretch fabric and wires or hang gates until the concrete has attained its full design strength.

3.2.4 Top Rails

Provide top rails that run continuously through post caps or extension arms, bending to radius for curved runs. Provide expansion couplings as recommended by the fencing manufacturer.

3.2.5 Brace Assembly

Provide bracing assemblies at end and gate posts and at both sides of corner and pull posts, with the horizontal brace located at midheight of the fabric.

Install brace assemblies so posts are plumb when the diagonal rod is under proper tension.

Provide two complete brace assemblies at corner and pull posts where required for stiffness and as indicated.

3.2.6 Tension Wire Installation

Install tension wire by weaving them through the fabric and tying them to each post with not less than 7-gage galvanized wire or by securing the wire to the fabric with 10-gage ties or clips spaced 18 inches on center.

3.2.7 Fabric Installation

Provide fabric in single lengths between stretch bars with bottom barbs placed approximately 1 inch above the CMU line. Pull fabric taut and tied to posts, rails, and tension wire with wire ties and bands.

Install fabric on the security side of fence, unless otherwise directed.

Ensure fabric remains under tension after the pulling force is released.

3.2.8 Stretcher Bar Installation

Thread stretcher bars through or clamped to fabric 4 inches on center and secured to posts with metal bands spaced 15 inches on center.

3.2.9 Gate Installation

Install gates plumb, level, and secure, with full opening without interference. Adjust hardware for smooth operation and lubricated where necessary.

3.2.10 Tie Wires

Provide tie wires that are U-shaped to the pipe diameters to which attached. Twist ends of tie wires not less than two full turns and bent so as not to present a hazard.

3.2.11 Fasteners

Install nuts for tension bands and hardware on the side of the fence opposite the fabric side. Peen ends of bolts to prevent removal of nuts.

3.2.12 Zinc-Coating Repair

Clean and repair galvanized surfaces damaged by welding or abrasion, and cut ends of fabric, or other cut sections with specified galvanizing repair material applied in strict conformance with the manufacturer's printed instructions.

3.2.13 Accessories Installation

3.2.13.1 Post Caps

Install post caps as recommended by the manufacturer.

3.3 CLOSEOUT ACTIVITIES

Remove waste fencing materials and other debris from the work site.

-- End of Section --

1

2

3

4

5

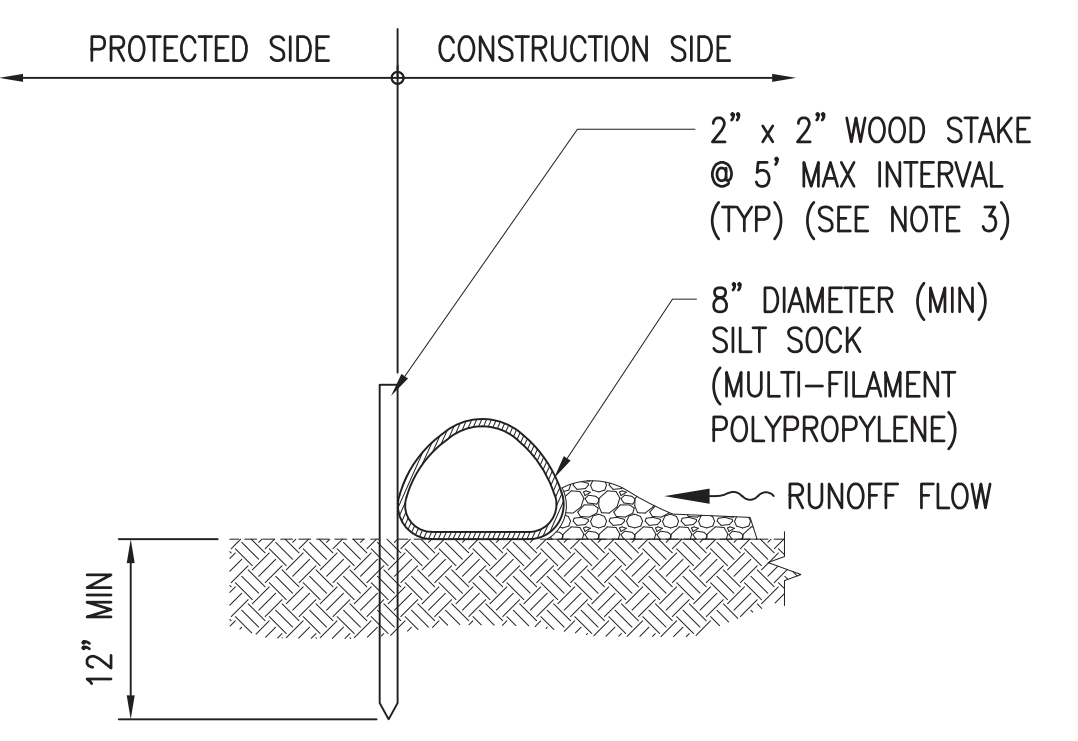

SECTION A-A

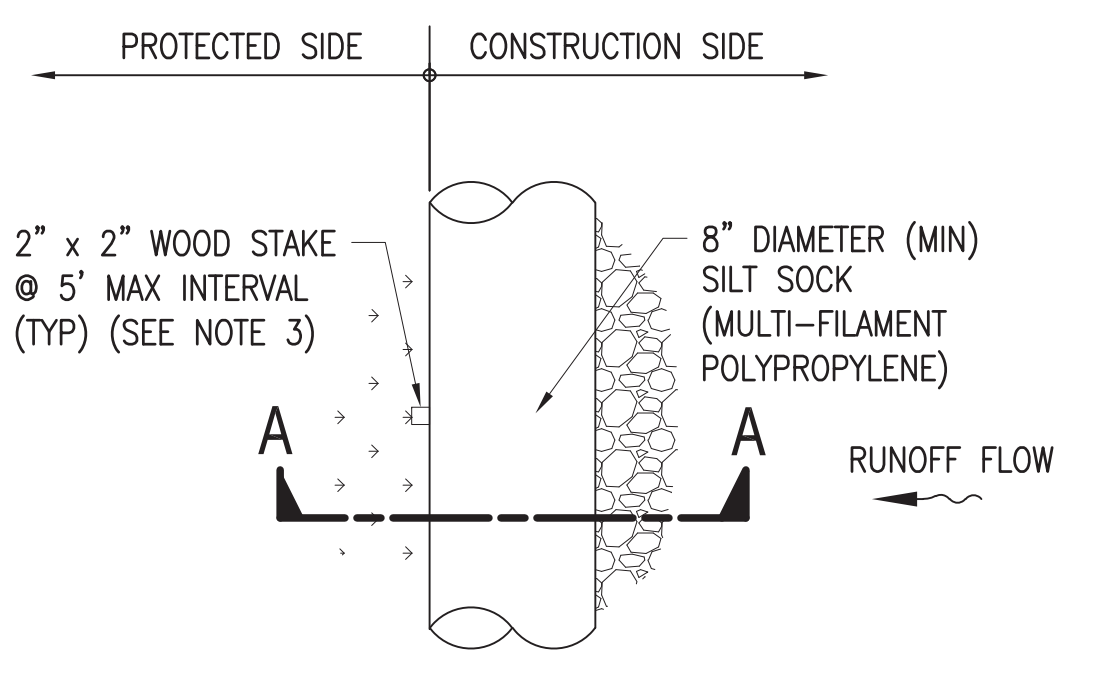

PLAN VIEW

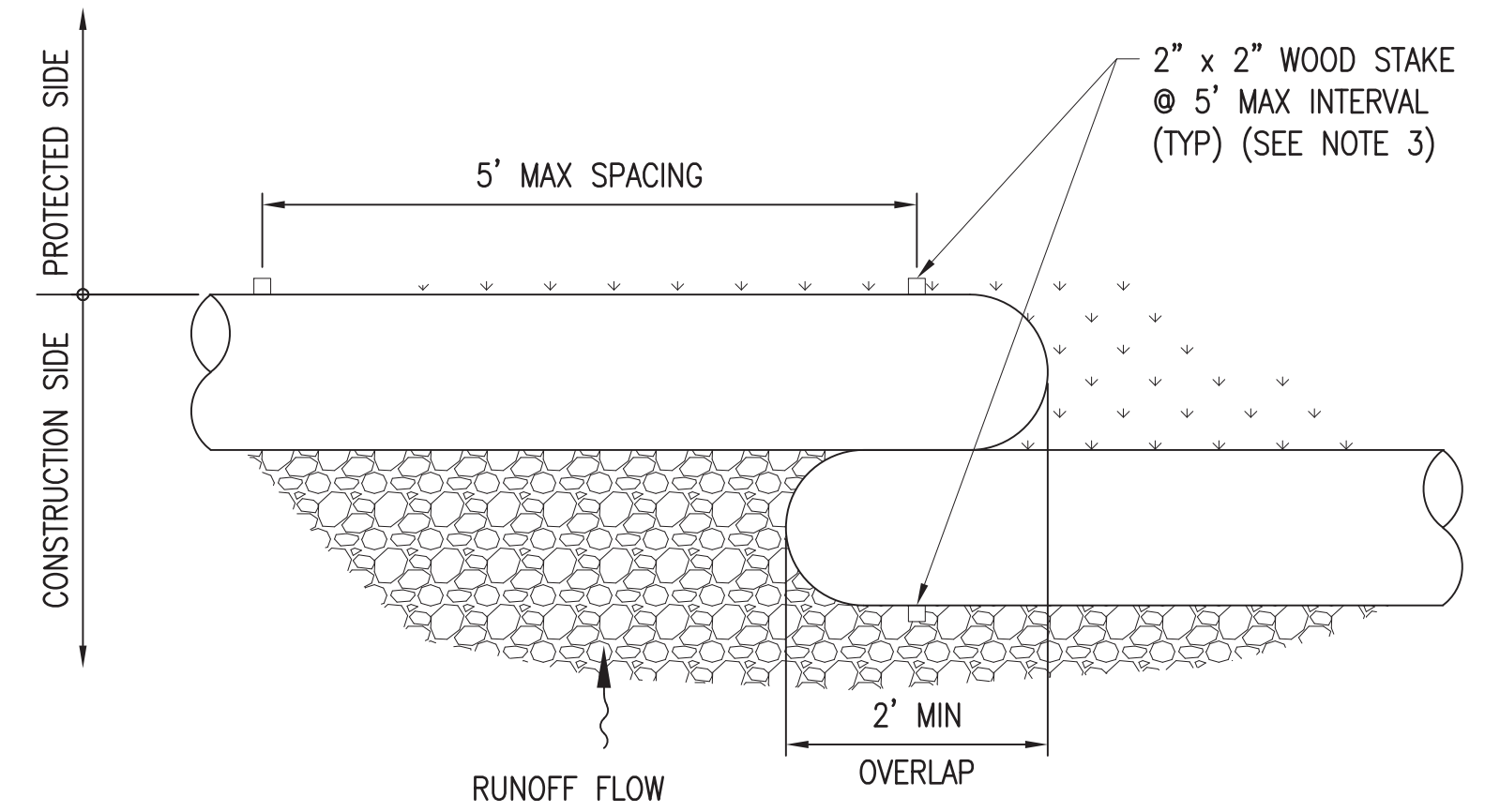

OVERLAP

LEGEND:

	EXISTING:	NEW:
TRAVERSE LINE	---	---
CONTOUR MAJOR	40	---
CONTOUR MINOR	41	---
CHAIN LINK FENCE	XXXXXX	XXXXXX
UTILITY/ELECTRICAL LINE	e	e
WATERLINE/IRR LINE	W2	---
FUEL LINE	LPG	---
SEWER LINE	SG	---
TEL/COMM LINE	COMM	---
SILT SOCK	○	○
SURFACE FLOW	~	~
BUILDING OR STRUCTURE	[Hatched Box]	[Hatched Box]
CONCRETE PAVING	[Dotted Box]	[Dotted Box]
TILE WALL	[Rectangular Box]	[Rectangular Box]
GRADING SLOPE	TOP BOT.	---
PALM TREE	[Palm Tree Symbol]	---
TREE	[Tree Symbol]	---
SHRUB	[Shrub Symbol]	---
SEWER CLEANOUT	SWCO	---
WATER VALVE	○	---
ELECT JUNCTION BOX	□	---
ELECT SWITCH BOX	□	---
ELECT VAULT	ELECT VAULT	---
CABLE TV BOX	CATV	---
ELECT CHILLER	□	---
HE BOX	HE BOX	---
IRR CONTROL VALVE	ICV	---
ARV BOX	□	---
SPOT ELEVATION	575	---
MONUMENT	○	---
SIGN	□	---

CIVIL NOTES:

1. VERIFY AND CHECK ALL DIMENSIONS AND DETAILS SHOWN ON THE DRAWINGS PRIOR TO THE START OF CONSTRUCTION. ANY DISCREPANCY MUST BE IMMEDIATELY BROUGHT TO THE ATTENTION OF CONTRACTING OFFICER FOR CLARIFICATION.
2. THE CONTRACTOR MUST OBSERVE AND COMPLY WITH ALL FEDERAL AND LOCAL LAWS REQUIRED FOR THE PROTECTION OF PUBLIC HEALTH, SAFETY AND ENVIRONMENTAL QUALITY.
3. THE CONTRACTOR MUST PREVENT SILT AND DEBRIS FROM ENTERING DRAINAGE, ROADWAYS AND OTHER AREAS. IF A BREACH OCCURS, THE CONTRACTOR MUST REMOVE ALL SILT AND DEBRIS RESULTING FROM HIS WORK DEPOSITED IN DRAINAGE FACILITIES, ROADWAYS AND OTHER AREAS.
4. THE EXISTENCE AND LOCATION OF UNDERGROUND UTILITIES AND STRUCTURES AS SHOWN ON THE PLANS ARE BASED ON THE LATEST AVAILABLE DATA. THE CONTRACTOR MUST VERIFY THE LOCATIONS AND DEPTHS OF THE EXISTING UTILITIES SHOWN AND EXERCISE PROPER CARE IN EXCAVATING IN THE AREA.
5. EXISTING UTILITIES MUST REMAIN IN-SERVICE AND IN PLACE UNLESS NOTED OTHERWISE. INTERRUPTION OF SERVICE MUST BE KEPT TO A MINIMUM AND MUST BE DONE ONLY WITH THE APPROVAL OF THE CONTRACTING OFFICER AND FACILITY USERS.
6. THE CONTRACTOR MUST PROVIDE SAFE ACCESS TO AND FROM ALL PARKING LOTS, SIDEWALKS, DRIVEWAYS AND STREETS.
7. THE CONTRACTOR MUST RESTORE TO THEIR OWN ORIGINAL CONDITION ALL IMPROVEMENTS DAMAGED AS A RESULT OF THE CONSTRUCTION, INCLUDING PAVEMENTS, EMBANKMENTS, CURBS, SIGNS, LANDSCAPING, STRUCTURES, UTILITIES, WALLS, FENCES, ETC.
8. THE PROJECT DESIGN MUST COMPLY WITH THE LATEST UNIFIED FACILITIES CRITERIA (UFC), UNIFIED FACILITIES GUIDE SPECIFICATIONS (UFGS), NATIONAL GUARD DESIGN GUIDES AND STANDARDS, AND ALL APPLICABLE CODES.

SURVEY NOTES:

1. EXISTING CONDITIONS ARE BASED ON TOPOGRAPHIC SURVEY CONDUCTED BY PARK ENGINEERING DATED APRIL 22, 2021 FIELD BOOK NO 3715.
2. UNDERGROUND UTILITY LINES AND STRUCTURES ARE PROVIDED FOR INFORMATION ONLY AND ARE BASED ON INFORMATION SHOWN ON PLANS AND MAPS PREPARED BY OTHERS. THE INFORMATION SHOWN, THEREFORE MAY OR MAY NOT BE REPRESENTATIVE OF ACTUAL FIELD CONDITIONS. THE UNDERGROUND UTILITY LINES AND STRUCTURES MAY OR MAY NOT BE PRESENT AT THE LOCATIONS SHOWN OR UNDERGROUND UTILITY LINES AND/OR STRUCTURES NOT SHOWN MAY BE PRESENT.
3. UNLESS OTHERWISE NOTED, ALL LOCATIONS OF UNDERGROUND UTILITY LINES AND/OR STRUCTURES ARE APPROXIMATE. NO GUARANTEE IS MADE ON THE ACCURACY OR COMPLETENESS OF THE INFORMATION SHOWN. THE USER(S) OF THIS TOPOGRAPHIC SURVEY MAP MUST VERIFY THE INFORMATION, AS NEEDED, DURING CONSTRUCTION.

DEMOLITION NOTES:

1. FOR ELECTRICAL DEMOLITION WORK, SEE ELECTRICAL DRAWINGS.
2. EXISTING UTILITIES MUST REMAIN UNLESS OTHERWISE NOTED.
3. THE CONTRACTOR MUST VERIFY TYPE OF UTILITY LINES PRIOR TO REMOVAL.

ABBREVIATIONS:

APPROX	APPROXIMATE	LF	LINEAR FEET
BLDG	BUILDING	MAX	MAXIMUM
BMP	BEST MANAGEMENT PRACTICES	MIN	MINIMUM
CONC	CONCRETE	NO	NUMBER
CL	CENTER LINE OR CLASS	NTS	NOT TO SCALE
CLF	CHAIN LINK FENCE	OC	ON CENTER
CONST	CONSTRUCTION OR CONSTRUCT	OD	OUTSIDE DIAMETER
D, DIA	DIAMETER	PAV'T	PAVEMENT
DEMO	DEMOLISH	PCC	PORTLAND CEMENT CONCRETE
DET	DETAIL	PL	PROPERTY LINE
DWG	DRAWING	PSI	POUNDS PER SQUARE INCH
ELEV	ELEVATION	STD	STANDARD
EX, EXIST	EXISTING	TYP	TYPICAL
EW	EACH WAY	UON	UNLESS OTHERWISE NOTED
FG	FINISHED GRADE	VIF	VERIFY IN FIELD
FOUND	FOUNDATION	W/	WITH
FT	FOOT		
GALV	GALVANIZED		
GOV'T	GOVERNMENT		

NOTES:

1. SILT SOCK COMPOST FILL MUST NOT CONTAIN BIOSOLIDS AND SHOULD BE CONSISTENT WITH EPA GUIDELINES.
2. SILT SOCK MUST BE PLACED HORIZONTAL ON SLOPES WITH THE ENDS OF THE SILT SOCK POINTING UPSLOPE TO PREVENT STORM WATER FROM RUNNING AROUND SILT SOCK ENDS.
3. AREAS WHERE SILT SOCK WILL BE ON HARD SURFACE/PAVEMENT, THE CONTRACTOR MUST PROVIDE GRAVEL BAGS CONTAINING CLEAN PEA-SIZE IN LIEU OF STAKES AND SPACED AS NOTED FOR STAKES. THE CONTRACTOR MUST ASSURE THE SILT SOCK FIRMLY SECURED.
4. THE CONTRACTOR MUST INSPECT THE SILT SOCK REGULARLY OR AFTER EACH RAIN EVENT AND ASSURE THE SILT SOCK IS PERFORMING PROPERLY.
5. SOCK MESH MUST BE A SINGLE-PLY, POLYPROPYLENE, KNITTED MESH WITH 1/8" TO 3/8" OPENINGS.
6. MANUFACTURER MUST PROVIDE THIRD PARTY TESTING/RESEARCH ON THEIR PRODUCT PERFORMANCE, WHICH MUST MEET OR EXCEED 80% TSS REMOVAL EFFICIENCY.

A1 SILT SOCK DETAILS
NTS

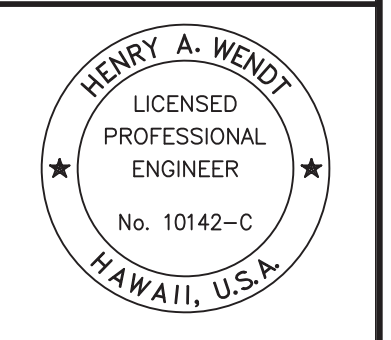

Signature: Henry A. Wendt
 04/30/2024
 Expiration Date
 THIS WORK WAS PREPARED BY ME OR UNDER MY SUPERVISION AND CONSTRUCTION OF THIS PROJECT WILL BE UNDER MY OBSERVATION.

SYMBOL	DESCRIPTION	DATE	APPROVED

SUBMITTAL PHASE

DATE: 06/16/23

DES	CP	DRW	RAJ	CHK	HW
-----	----	-----	-----	-----	----

DEPARTMENT OF DEFENSE
 HAWAII ARMY NATIONAL GUARD
 DESIGN AND PROJECT MANAGEMENT BRANCH
 WAIHAWA, OAHU
 WHEELER AASF #1 BLDG. 00823
WHEELER CONSTRUCTION OF STAND-BY EMERGENCY GENERATOR INSTALLATIONS
 NOTES, LEGEND, ABBREVIATIONS, & SILT SOCK DETAILS

SCALE: AS NOTED

STATE JOB NO. WHEELER CA-202004-C1

FEDERAL PROJECT NO. 15190004

SHEET 3 OF 17

C002

1

2

3

4

5

EROSION PREVENTION/SEDIMENT CONTROL NOTES

- EROSION AND SEDIMENT CONTROL MEASURES MUST BE IN PLACE AND FUNCTIONAL BEFORE EARTHWORK IS INITIATED.
- EROSION CONTROL MEASURES MUST BE CHECKED AND REPAIRED AS NECESSARY, FOR EXAMPLE, WEEKLY IN DRY PERIODS AND WITHIN 24 HOURS AFTER RAINFALL OF 0.25 INCHES OR GREATER WITHIN A 24-HOUR PERIOD. DURING PROLONGED RAINFALL, DAILY CHECK IS NECESSARY. THE RECORDS OF CHECKS AND REPAIRS MUST BE MAINTAINED.
- TEMPORARY STABILIZATION IS REQUIRED ON DISTURBED AREAS WHICH ARE AT FINAL GRADE OR WHEN THE DISTURBED AREA WILL NOT BE WORKED FOR 14 CONSECUTIVE DAYS OR MORE.
- DISTURBED AREAS MUST BE PERMANENTLY STABILIZED USING VEGETATIVE COVERING, PAVEMENT, OR EQUIVALENT SURFACE TREATMENT, PRIOR TO REMOVING EROSION AND SEDIMENT CONTROL MEASURES. TRAPPED SEDIMENT AND AREAS OF DISTURBED SOIL WHICH RESULT FROM THE REMOVAL OF THE TEMPORARY MEASURES MUST BE IMMEDIATELY AND PERMANENTLY STABILIZED.
- PRESERVE EXISTING VEGETATION. CLEARLY MARK THE AREAS TO BE PRESERVED.
- SEDIMENT BARRIERS
 - FILTER SOCK MUST BE USED TO PROTECT DISTURBED OR DENUDED AREAS THAT ARE NOT SCHEDULED FOR ACTIVE WORK WITHIN 24 HOURS. THE FILTER SOCK MUST BE PROVIDED WITHIN THE DISTURBED OR DENUDED AREAS.
- INLET PROTECTION
 - STORM DRAIN INLETS ON-SITE AND THOSE OFF-SITE WHICH MAY RECEIVE RUN-OFF FROM THE SITE MUST USE AN INLET PROTECTION DEVICE.
 - SEDIMENT LEVELS MAY NOT EXCEED ONE THIRD OF THE HEIGHT OF A SEDIMENT BARRIER OR INLET PROTECTION DEVICE ALONG THE LENGTH OF THE SEDIMENT BARRIER OF THE INLET PROTECTION DEVICE.
 - SEDIMENT BARRIERS AND INLET PROTECTION DEVICES MUST BE UNBLOCKED AND CLEANED WHEN PERFORMANCE IS COMPROMISED.
 - TORN, WEATHERED OR SAGGING SEDIMENT BARRIERS OR INLET PROTECTION DEVICES MUST BE REPAIRED OR REPLACED IMMEDIATELY.
- TRACKING CONTROL
 - MINIMIZE SEDIMENT TRACK-OUT ONTO OFF-SITE STREET, OTHER PAVED AREAS, AND SIDEWALK FROM VEHICLES EXITING THE CONSTRUCTION SITE BY RESTRICTING VEHICLES TRAFFIC TO PROPERLY DESIGNATED AREAS AND USING ADDITIONAL CONTROLS TO REMOVE SEDIMENT FROM VEHICLE TIRES PRIOR TO EXITING THE SITE.
 - VEHICULAR PARKING AND MOVEMENTS ON PROJECT SITES MUST BE CONFINED TO PAVED SURFACES OR PREDEFINED PARKING AREAS AND VEHICLE PATHS, WHICH MUST BE MARKED WITH FLAGS OR BOUNDARY FENCING.
 - POLLUTANTS AND MATERIALS THAT ARE DROPPED, WASHED, TRACKED, SPILLED, OR OTHERWISE DISCHARGED FROM A PROJECT SITE TO OFF-SITE STREETS, OTHER PAVED AREAS, SIDEWALKS OR THE DRAINAGE SYSTEM MUST BE CLEANED USING DRY METHODS SUCH AS SWEEPING OR VACUUMING BY THE END OF EACH WORK DAY.
 - WASHING POLLUTANTS AND MATERIALS THAT ARE DISCHARGED FROM THE PROJECT SITE TO THE DRAINAGE SYSTEM DRAIN INLETS IS PROHIBITED.
- THE STABILIZED AREAS MUST BE MAINTAINED AND EROSION CONTROL MEASURES REMOVED AFTER THE DISTURBED SITE IS PERMANENTLY STABILIZED.
- CONTRACTOR AND SUBCONTRACTORS MUST BE TRAINED ON THE BEST MANAGEMENT PRACTICES.
- CONSTRUCT FACILITIES TO RETAIN ON-SITE WASTEWATER SUCH AS WASH WATER AFTER CLEANING CONCRETE TRUCKS.
- STORM WATER FLOWING TOWARD THE CONSTRUCTION AREA MUST BE DIVERTED BY USING APPROPRIATE CONTROL MEASURES AS PRACTICAL.
- THE FINAL LIFT OF EACH DAYS WORK MUST BE COMPACTED TO PREVENT EROSION OF FILL MATERIALS.
- VEGETATION, DEMOLITION MATERIALS AND CONSTRUCTION WASTES MUST BE PROPERLY DISPOSED OF OFF-SITE.
- FILTER SOCK OR OTHER EROSION CONTROL BARRIERS MUST BE CLEARED OF SILT IMMEDIATELY FOLLOWING THE END OF RAINFALL THAT CAUSES SILT BUILDUP ON THE FABRIC.
- PRIOR TO A LARGE STORM EVENT, DISTURBED EARTH MUST BE ROLLED TO SEAL THE SURFACE AND REDUCE SOIL EROSION.
- LIQUIDS AND HAZARDOUS MATERIALS MUST BE STORED OVER A ROOFED SECONDARY CONTAINMENT. THE CONTAINMENT VOLUME MUST BE EQUAL TO THE LARGEST CONTAINER VOLUME. SECONDARY CONTAINMENT MUST BE LOCATED AT LEAST 50 FEET AWAY FROM DRAIN INLETS AND RECEIVING WATERS.

GOOD HOUSEKEEPING BMPS

- STREET SWEEPING AND VACUUMING. POLLUTANTS DISCHARGED FROM THE CONSTRUCTION SITE TO OFF-SITE AREAS MUST BE SWEEP OR VACUUMED EACH DAY BEFORE LEAVING THE JOB SITE.
- MATERIALS DELIVERY, STORAGE AND USE MANAGEMENT. PREVENT, REDUCE, OR ELIMINATE THE DISCHARGE OF POLLUTANTS FROM MATERIAL DELIVERY, STORAGE, AND USE TO THE STORM WATER SYSTEM OR WATERCOURSES BY MINIMIZING THE STORAGE OF HAZARDOUS MATERIALS ON-SITE, STORING MATERIALS IN A DESIGNATED AREA, AND INSTALLING SECONDARY CONTAINMENT. CONSTRUCTION MATERIALS, WASTE, TOXIC AND HAZARDOUS SUBSTANCES, STOCKPILES AND OTHER SOURCES OF POLLUTION MUST NOT BE STORED IN BUFFER AREAS, NEAR AREAS OF CONCENTRATED FLOW, OR AREAS ABUTTING THE EXISTING DRAINAGE SYSTEM, RECEIVING WATERS, OR DRAINAGE IMPROVEMENTS THAT DISCHARGE OFF-SITE. PRIMARY AND SECONDARY CONTAINMENT CONTROLS AND COVERS MUST BE IMPLEMENTED TO THE MAXIMUM EXTENT PRACTICABLE. IN THE EVENT THAT HAZARDOUS MATERIALS ARE DISCHARGED TO THE DRAINAGE SYSTEM, THE CONTRACTOR MUST IMMEDIATELY NOTIFY THE CONTRACTING OFFICER'S REPRESENTATIVE (COR).
- SPILL PREVENTION AND CONTROL. CREATE AND IMPLEMENT SPILL PREVENTION AND RESPONSE PLANS TO ELIMINATE AND MINIMIZE THE DISCHARGE OF POLLUTANTS TO THE DRAINAGE SYSTEM AND RECEIVING WATERS FROM LEAKS AND SPILLS BY REDUCING THE CHANCE FOR SPILLS, ABSORBING, CONTAINING, AND CLEANING UP SPILLS AND PROPERLY DISPOSING OF SPILL MATERIALS. AT A MINIMUM, ALL PROJECTS MUST CLEANUP ALL LEAKS AND SPILLS IMMEDIATELY.
- VEHICLE AND EQUIPMENT CLEANING. ELIMINATE AND MINIMIZE THE DISCHARGE OF POLLUTANTS TO STORM WATER FROM VEHICLE AND EQUIPMENT CLEANING OPERATIONS BY USING OFF-SITE FACILITIES WHEN FEASIBLE, WASHING IN DESIGNATED, CONTAINED AREAS ONLY, AND ELIMINATING DISCHARGES TO THE STORM DRAIN SYSTEM BY EVAPORATING AND/OR TREATING WASH WATER, OR INFILTRATING WASH WATER FOR EXTERIOR CLEANING ACTIVITIES THAT USE WATER ONLY.
- VEHICLE AND EQUIPMENT FUELING. PREVENT FUEL SPILLS AND LEAKS BY USING OFF-SITE FACILITIES, FUELING ONLY IN DESIGNATED AREAS, ENCLOSING OR COVERING STORED FUEL, AND IMPLEMENTING SPILL CONTROLS SUCH AS SECONDARY CONTAINMENT AND ACTIVE MEASURES USING SPILL RESPONSE KITS.
- VEHICLE AND EQUIPMENT MAINTENANCE. ELIMINATE AND MINIMIZE THE DISCHARGE OF POLLUTANTS TO STORM WATER FROM VEHICLE AND EQUIPMENT MAINTENANCE OPERATIONS BY USING OFF-SITE FACILITIES WHEN FEASIBLE, PERFORMING WORK IN DESIGNATED AREAS ONLY, USING SPILL PADS UNDER VEHICLES AND EQUIPMENT, CHECKING FOR LEAKS AND SPILLS, AND CONTAINING AND CLEANING UP SPILLS IMMEDIATELY.
- SOLID WASTE MANAGEMENT. PREVENT OR REDUCE DISCHARGE OF POLLUTANTS TO THE LAND, GROUNDWATER, AND IN STORM WATER FROM SOLID WASTE OR CONSTRUCTION AND DEMOLITION WASTE BY PROVIDING DESIGNATED WASTE COLLECTION AREAS, COLLECT SITE TRASH DAILY, AND ENSURING THAT CONSTRUCTION WASTE IS COLLECTED, REMOVED, AND DISPOSED OF ONLY AT AUTHORIZED DISPOSAL AREAS.
- SANITARY/SEPTIC WASTE MANAGEMENT. TEMPORARY AND PORTABLE SANITARY AND SEPTIC WASTE SYSTEMS MUST BE MOUNTED OR STAKED IN, WELL-MAINTAINED AND SCHEDULED FOR REGULAR WASTE DISPOSAL AND SERVICING. SOURCES OF SANITARY AND/OR SEPTIC WASTE MUST NOT BE STORED NEAR THE DRAINAGE SYSTEM OR RECEIVING WATERS.
- STOCKPILE MANAGEMENT. STOCKPILES MUST NOT BE LOCATED IN DRAINAGE WAYS, WITHIN 50 FEET FROM AREAS OF CONCENTRATED FLOWS. FILTER SOCKS MUST BE USED AROUND THE BASE OF ALL STOCKPILES. STOCKPILES MUST NOT EXCEED 15 FEET IN HEIGHT. STOCKPILES GREATER THAN 15 FEET IN HEIGHT MUST REQUIRE 8 FOOT WIDE BENCHING. STOCKPILES MUST BE COVERED WITH PLASTIC SHEETING OR A COMPARABLE MATERIAL IF THEY WILL NOT BE ACTIVELY USED WITHIN 7 DAYS.
- LIQUID WASTE MANAGEMENT. LIQUID WASTE MUST BE CONTAINED IN A CONTROLLED AREA SUCH AS A HOLDING PIT, SEDIMENT BASIN, ROLL-OFF BIN, OR PORTABLE TANK OF SUFFICIENT VOLUME AND TO CONTAIN THE LIQUID WASTES GENERATED. CONTAINMENT AREAS OR DEVICES MUST BE IMPERMEABLE AND LEAK FREE AND MUST NOT BE LOCATED WHERE ACCIDENTAL RELEASE OF THE CONTAINED LIQUID CAN DISCHARGE TO WATER BODIES, CHANNELS, OR STORM DRAINS.
- CONCRETE WASTE MANAGEMENT. PREVENT OR REDUCE THE DISCHARGE OF POLLUTANTS TO STORM WATER FROM CONCRETE WASTE BY CONDUCTING WASHOUT OFF-SITE OR PERFORMING ON-SITE WASHOUT IN A DESIGNATED AREA CONSTRUCTED AND MAINTAINED IN SUFFICIENT QUANTITY AND SIZE TO CONTAIN LIQUID AND CONCRETE WASTE GENERATED BY WASHOUT OPERATIONS. PLASTIC LINING MATERIAL MUST BE A MINIMUM OF 10 MILLIMETER POLYETHYLENE SHEETING AND MUST BE FREE OF HOLES, TEARS, OR OTHER DEFECTS THAT COMPROMISE THE IMPERMEABILITY OF THE MATERIAL. CONTAINMENT AREAS OR DEVICES MUST NOT BE LOCATED WHERE ACCIDENTAL RELEASE OF THE CONTAINED LIQUID CAN DISCHARGE TO WATER BODIES, CHANNELS, OR STORM DRAINS. WASHOUT FACILITIES MUST BE CLEANED, OR NEW FACILITIES MUST BE CONSTRUCTED AND READY FOR USE ONCE THE WASHOUT IS 75 PERCENT FULL. ONCE CONCRETE WASTES ARE WASHED INTO THE DESIGNATED AREA AND ALLOWED TO HARDEN, THE CONCRETE MUST BE BROKEN UP, REMOVED, AND DISPOSED OF AS SOLID WASTES.
- DUST CONTROL. THE CONTRACTOR AT THIS OWN EXPENSE SHALL KEEP THE PROJECT AREA FREE FROM DUST NUISANCE. THE WORK SHALL BE IN CONFORMANCE WITH THE HAWAII ADMINISTRATIVE RULES: TITLE CHAPTER 60, "AIR POLLUTION CONTROL".

EROSION AND SEDIMENT CONTROL PLAN SCHEDULE AND RAIN RESPONSE PLAN

PROJECT SEQUENCE:

- INSTALL PERIMETER CONTROLS FOR PROTECTED AREAS.
- MAINTAIN BMPS AS NEEDED TO KEEP THEM EFFECTIVE AT ALL TIMES. INITIATE TEMPORARY STABILIZATION IMMEDIATELY ONCE GRADING IS COMPLETED.
- PROCEED WITH CONSTRUCTION WITH LEAST POSSIBLE DISTURBANCE OF VEGETATIVE AREAS.
- PRACTICE GOOD HOUSEKEEPING MEASURES THROUGHOUT THE DURATION OF CONSTRUCTION.

RAIN RESPONSE PLAN:

- THE FOLLOWING WILL BE PERFORMED WHEN HEAVY RAINS, TROPICAL STORM OR HURRICANE IS IMMINENT OR IS FORECASTED IN THE NEXT 48 HOURS:
- TEMPORARY SUSPENSION OF ACTIVE GRADING.
 - INSPECT ALL PERIMETER CONTROLS, AND MAINTAIN AS NEEDED. REINSTALL ANY PERIMETER CONTROLS THAT WERE REMOVED DUE TO ACTIVE WORK IN THE AREA. IF A SEVERE STORM IS EXPECTED, REMOVE INLET PROTECTION DEVICES TO PREVENT FLOODING ON SURROUNDING STREETS.
 - PLACE SPILL PANS OR OIL-ONLY SPILL PADS UNDER CONSTRUCTION VEHICLES TO PREVENT RUN-OFF FROM CONTACTING ANY SPILLED PETROLEUM PRODUCTS. PROPERLY DISPOSE OF ANY ACCUMULATED OILY WATER AFTER THE RAIN EVENT.
 - RE-INSPECT AFTER THE APPROACHING HEAVY RAINS, TROPICAL STORM OR HURRICANE AND REPLACE OR MAINTAIN BMPS AS NEEDED.

HAWAII ARMY NATIONAL GUARD

DESIGN AND PROJECT MANAGEMENT BRANCH

WHAHAWA, OAHU

WHEELER CONSTRUCTION OF WHEELER AASF #1 BLDG. 00823

STAND-BY EMERGENCY GENERATOR INSTALLATIONS

EROSION AND SEDIMENT CONTROL NOTES

DEPARTMENT OF DEFENSE

STATE OF HAWAII

FACILITY MANAGEMENT OFFICE

FEDERAL PROJECT NO. 15190004

SHEET 4 OF 17

SCALE: AS NOTED

STATE JOB NO. WHEELER CA-202004-C1

06/16/23

DES CP DRW RAI CHK HW

04/02/2024
Expiration Date
of this License
No. 10142-C
HAWAII, U.S.A.

LICENSED PROFESSIONAL ENGINEER
HENRY A. WENDT

Signature:  04/02/2024
Expiration Date
of this License
No. 10142-C
HAWAII, U.S.A.

THIS WORK WAS PREPARED BY ME OR UNDER MY SUPERVISION AND CONSTRUCTION OF THIS PROJECT WILL BE UNDER MY OBSERVATION.

1

2

3

4

5

D

C

B

A

D

C

B

A

FOR DEMOLITION WORK, SEE A4
C102

FOR NEW WORK, SEE A3
C103

FOR EROSION AND SEDIMENT
CONTROL PLAN, SEE A1
C102



BENCH MARK
"CUT 603
ELEV=841.80
FB 3715/20

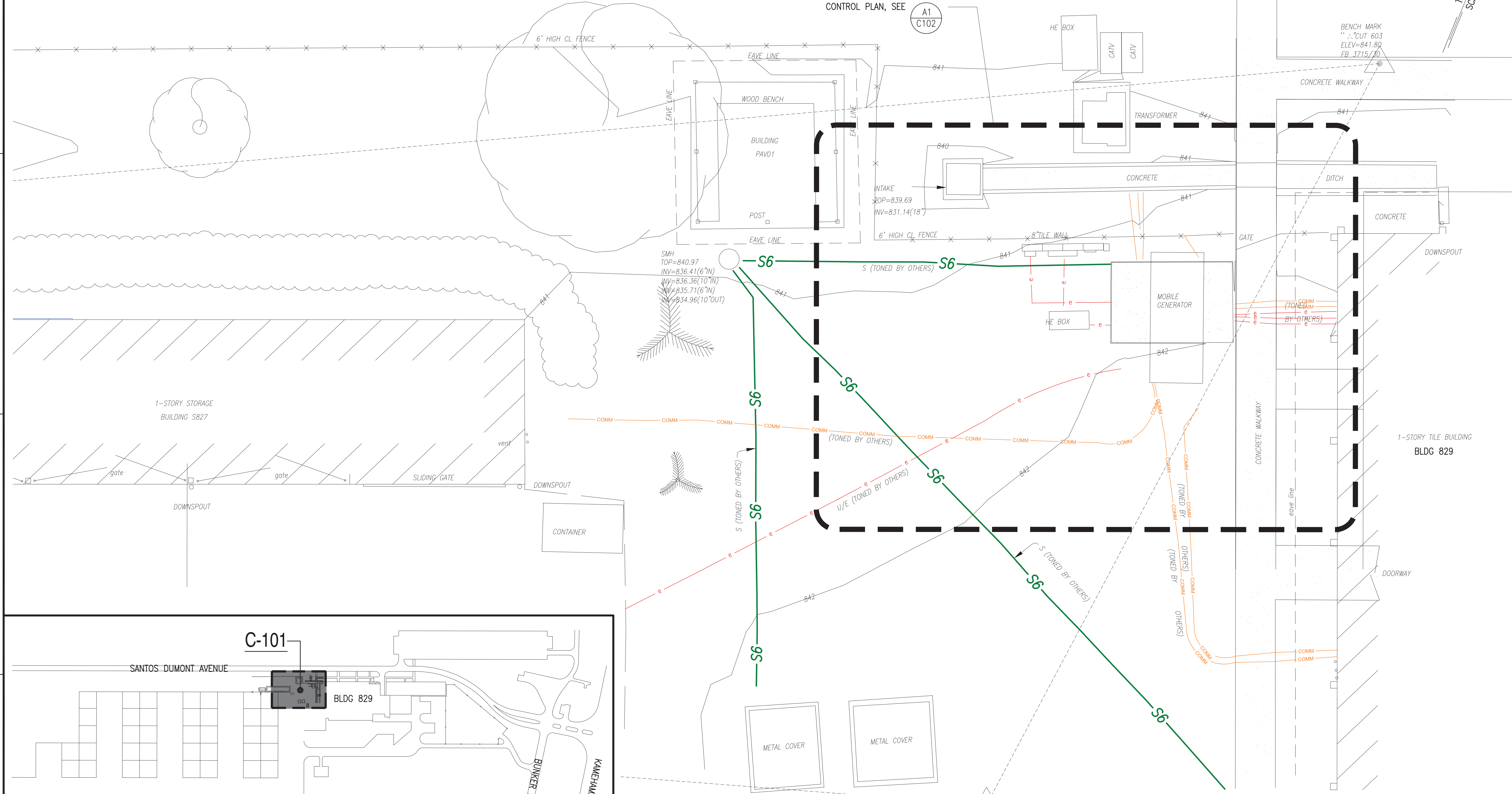

BK BOWERS • KUBOTA CONSULTING
Project Manager • Designer • Architect/Engineer/Geologist • Contractor Designer

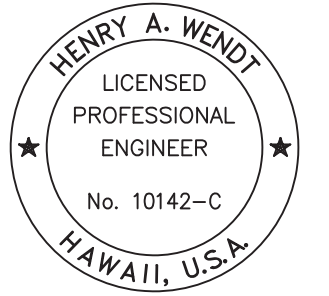

Henry A. Wendt
Signature
04/30/2024
Expiration Date
MY SUPERVISION AND CONSTRUCTION OF
THIS PROJECT WILL BE UNDER MY
OBSERVATION.

DATE	DESCRIPTION

DES	CP	DRW	RAJ	CHK	HW
-----	----	-----	-----	-----	----

DEPARTMENT OF DEFENSE
HAWAII ARMY NATIONAL GUARD
DESIGN AND PROJECT MANAGEMENT BRANCH
WHAHAWA, OAHU
STATE OF HAWAII
FACILITY MANAGEMENT OFFICE
WHEELER AASF #1 BLDG. 00829
WHEELER CONSTRUCTION OF
STAND-BY EMERGENCY GENERATOR INSTALLATIONS
PARTIAL ENLARGED GENERAL SITE PLAN

SCALE: AS NOTED

STATE JOB NO. WHEELER CA-202004-C1

FEDERAL PROJECT NO. 15190004

SHEET 5 OF 17

C101



A3 PARTIAL ENLARGED GENERAL SITE PLAN
SCALE: 1"=5'

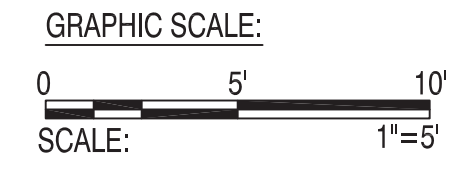

"CUT 602
ELEV=842.17
FB 3715/21

INTAKE
TOP=842.20
FLR=832.81

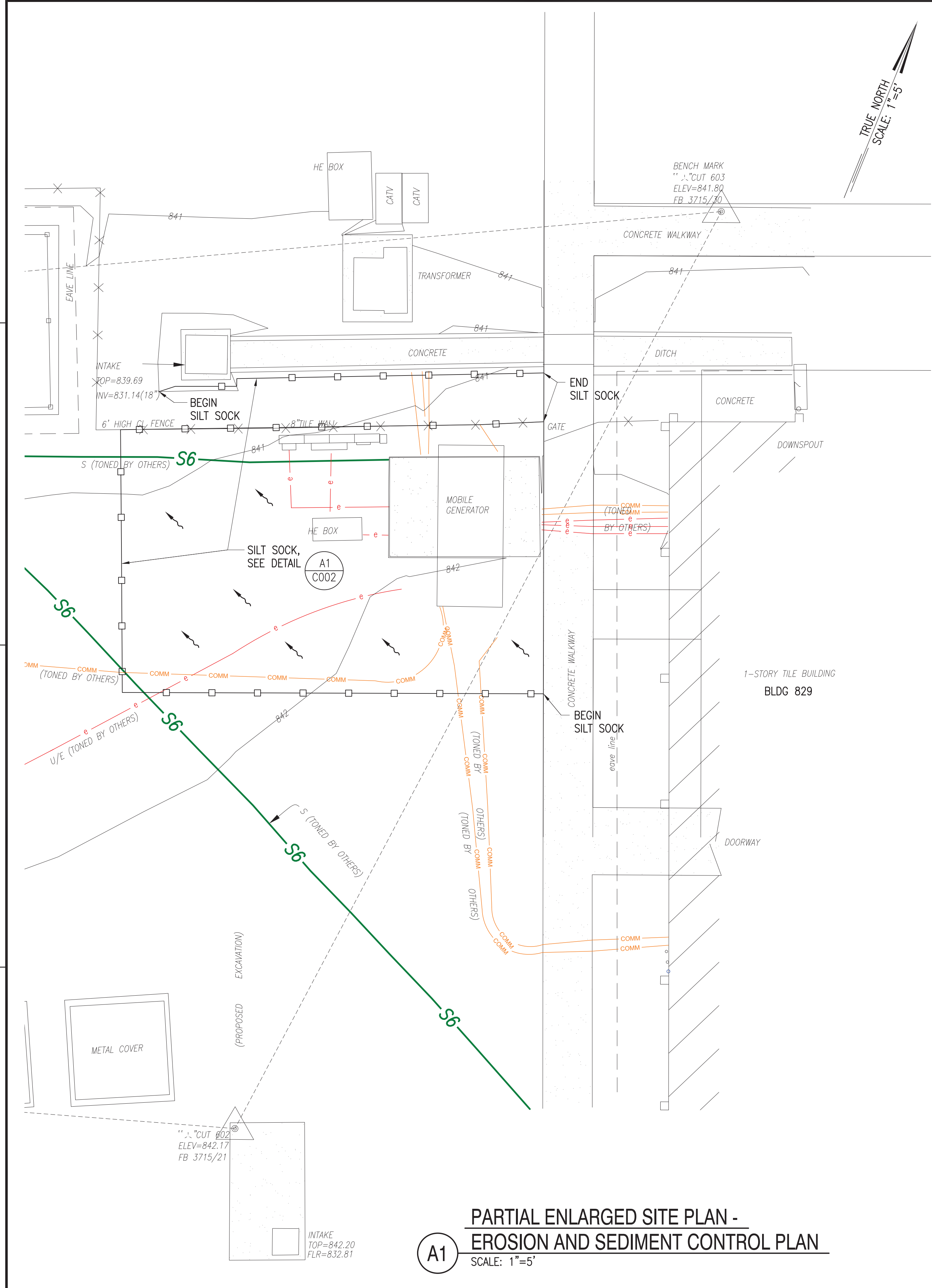

**PARTIAL ENLARGED SITE PLAN -
EROSION AND SEDIMENT CONTROL PLAN**
SCALE: 1"=5'

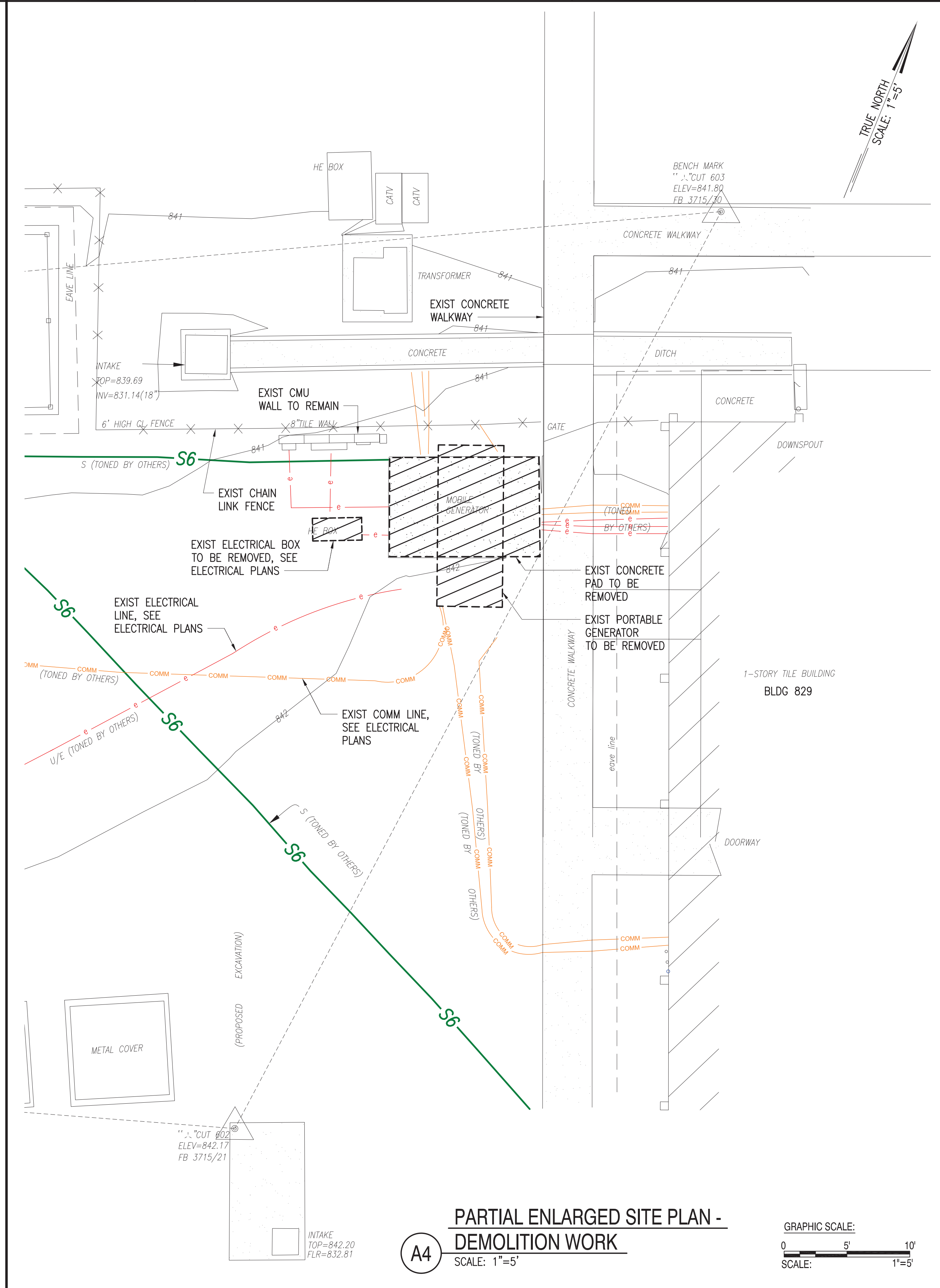

**PARTIAL ENLARGED SITE PLAN -
DEMOLITION WORK**
SCALE: 1"=5'

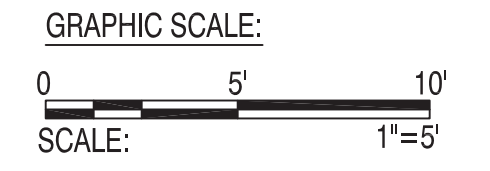



BOWERS • KUBOTA CONSULTING

HENRY A. WENDT
LICENSED PROFESSIONAL ENGINEER
No. 10142-C
HAWAII, U.S.A.

Henry A. Wendt
Signature
04/30/2024
Expiration Date
of the License
MY SUPERVISION AND CONSTRUCTION OF
THIS PROJECT WILL BE UNDER MY
OBSERVATION.

DATE	DESCRIPTION	APPR.

DEPARTMENT OF DEFENSE
DESIGN AND PROJECT MANAGEMENT BRANCH
HAWAIIA, OAHU

STATE OF HAWAII
FACILITY MANAGEMENT OFFICE
WHEELER AASF #1 BLDG. 00823

**WHEELER CONSTRUCTION OF
STAND-BY EMERGENCY GENERATOR INSTALLATIONS**

PARTIAL ENLARGED SITE PLAN - EROSION AND SEDIMENT CONTROL PLAN & DEMOLITION WORK

SCALE: AS NOTED

STATE JOB NO.
WHEELER CA-202004-C1

FEDERAL PROJECT NO.
15190004

SHEET 6 OF 17

C102

1

2

3

4

5

D

C

B

A



BOWERS • KUBOTA CONSULTING

HENRY A. WENDT
LICENSED PROFESSIONAL ENGINEER
No. 10142-C
HAWAII, U.S.A.

Signature
04/30/2024
Expiration Date of the License
MY SUPERVISION AND CONSTRUCTION OF THIS PROJECT WILL BE UNDER MY OBSERVATION.

SYMBOL	DESCRIPTION
D3	C502
A4	C501

06/16/23

DES CP DRW RAI CHK HW

DEPARTMENT OF DEFENSE
DESIGN AND PROJECT MANAGEMENT BRANCH
WAHIAWA, OAHU

HAWAII ARMY NATIONAL GUARD
WHEELER AASF #1 BLDG. 00823

WHEELER CONSTRUCTION OF
STAND-BY EMERGENCY GENERATOR INSTALLATIONS

PARTIAL ENLARGED SITE PLAN - NEW WORK

STATE OF HAWAII
FACILITY MANAGEMENT OFFICE

SCALE: AS NOTED

STATE JOB NO.
WHEELER CA-202004-C1

FEDERAL PROJECT NO.
15190004

SHEET 7 OF 17

C103

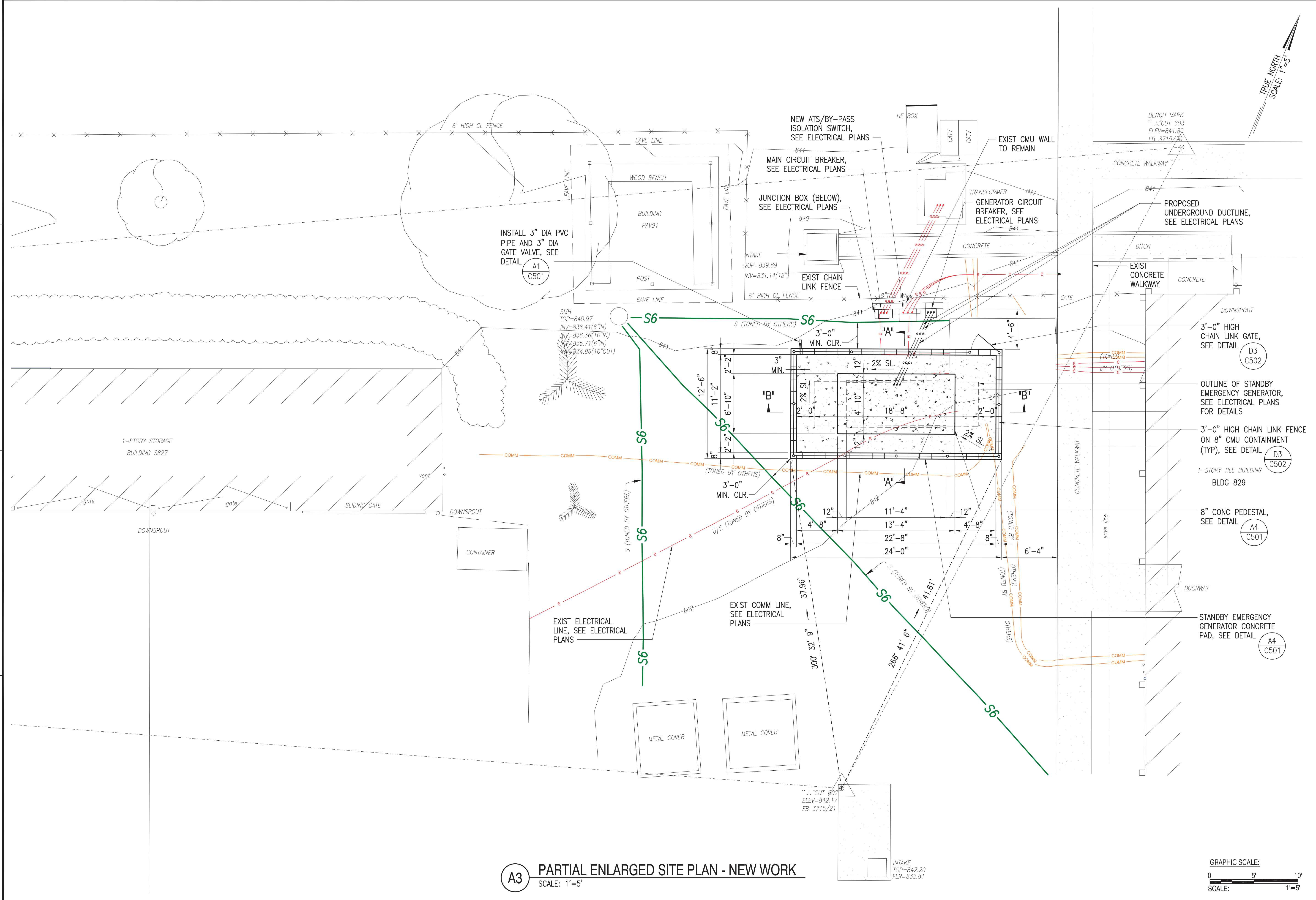
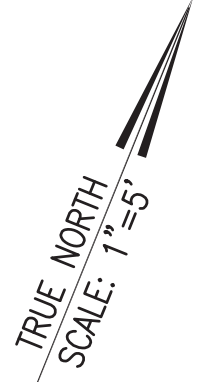

A3 PARTIAL ENLARGED SITE PLAN - NEW WORK
SCALE: 1"=5'

1

2

3

4

5

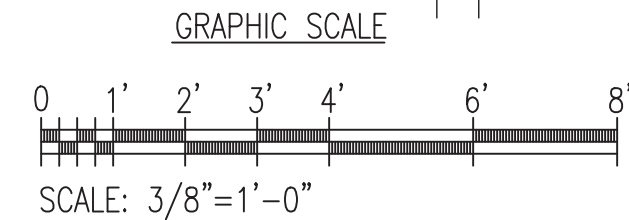
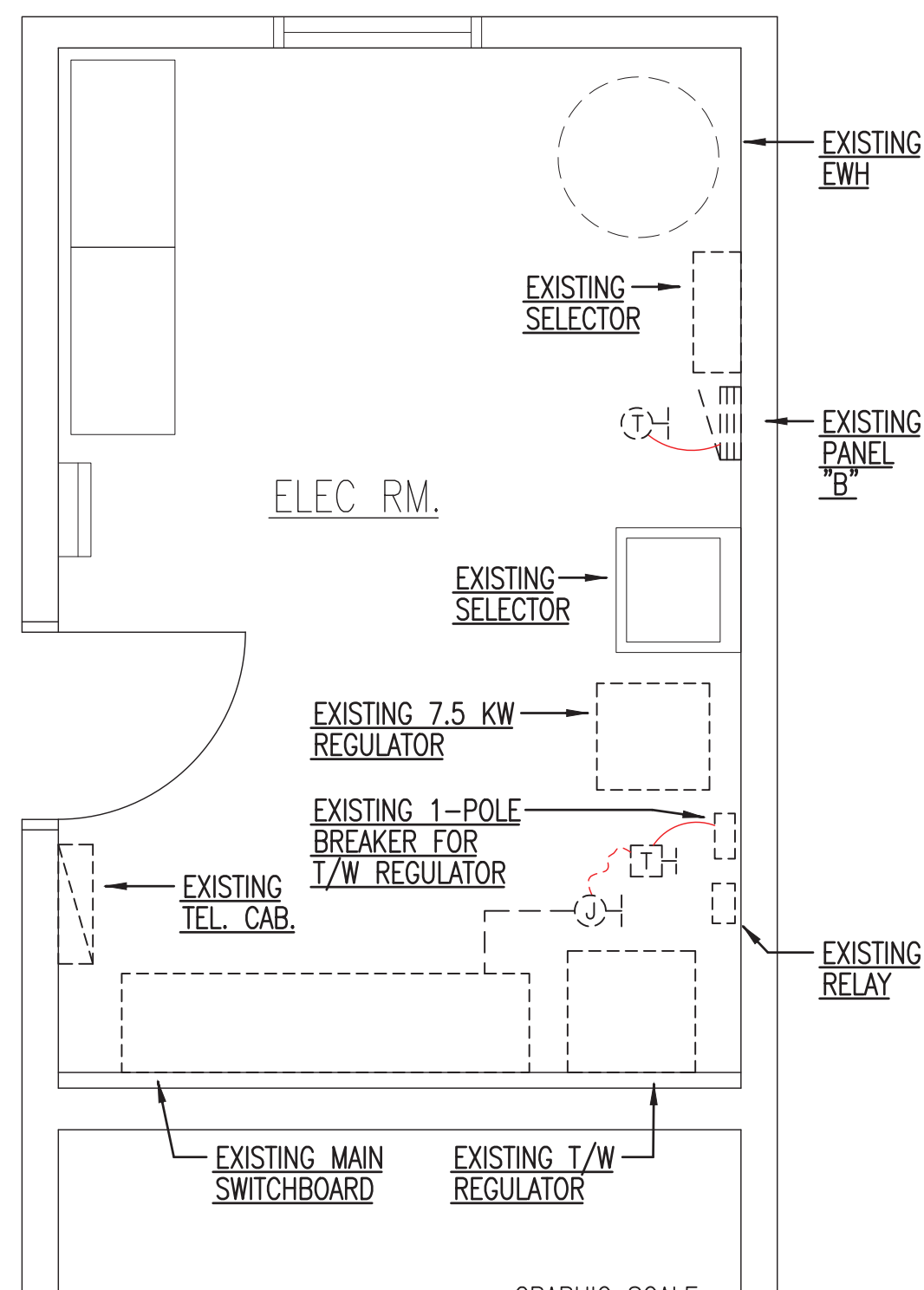

A1 ELEC. RM. - ELEC. PLAN
SCALE: 3/8" = 1' - 0"

NOTES:

- BACKFILL MATERIAL TYPE "A"
BLACK OR BEACH SAND, EARTH AND GRAVEL MIXTURE. IF EARTH & GRAVEL MIXTURE, ROCK SIZE SHALL BE 1-INCH OR SMALLER AND SHALL NOT CONTAIN MORE THAN 50% ROCK PARTICLES BY VOLUME. THIS FILL SHALL BE USED OVER CONCRETE ENCASED DUCTS AND OVER DIRECT BURIED DUCTS AND CABLES AFTER BACKFILL TYPE "B" HAS BEEN PLACED IN ACCORDANCE WITH DRAWINGS.
- BACKFILL MATERIAL TYPE "B"
BLACK OR BEACH SAND, EARTH AND GRAVEL MIXTURE. IF EARTH & GRAVEL MIXTURE MUST PASS A 1/2-INCH SCREEN AND CONTAIN NOT MORE THAN 20% ROCK PARTICLES BY VOLUME. THIS FILL SHALL BE ALL AROUND DIRECT BURIED CONDUITS AND CABLES AS SHOWN ON DRAWINGS.
- ALL DUCTS SHALL BE PVC SCHEDULE 80.
- PROVIDE DETECTABLE DUCT WARNING TAPE 12" BELOW FINISH GRADE OR PAVEMENT DIRECTLY ABOVE DUCTS.
- TUNNEL UNDER EXISTING CONCRETE WALKWAYS TO INSTALL NEW DUCTLINE. DO NOT CUT SIDEWALKS.

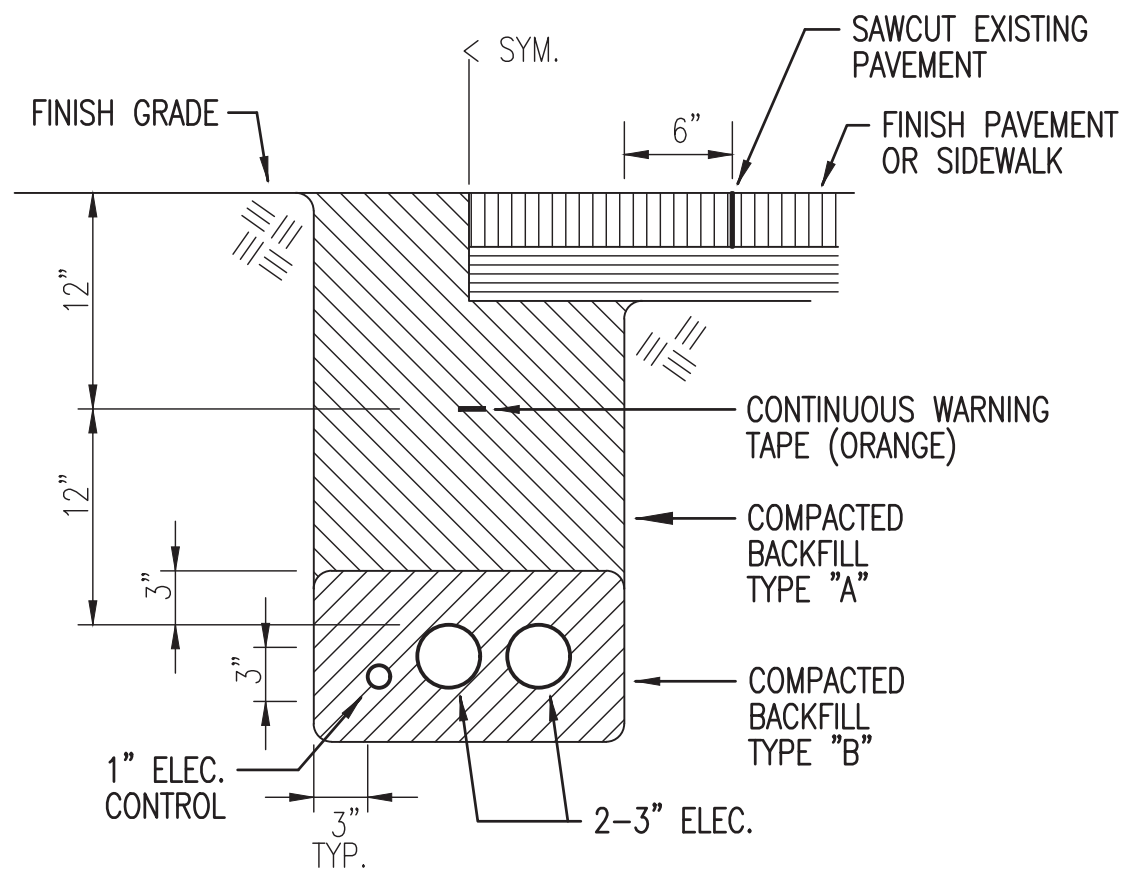

A DUCT SECTION

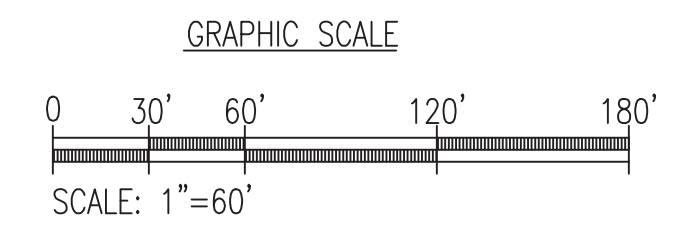
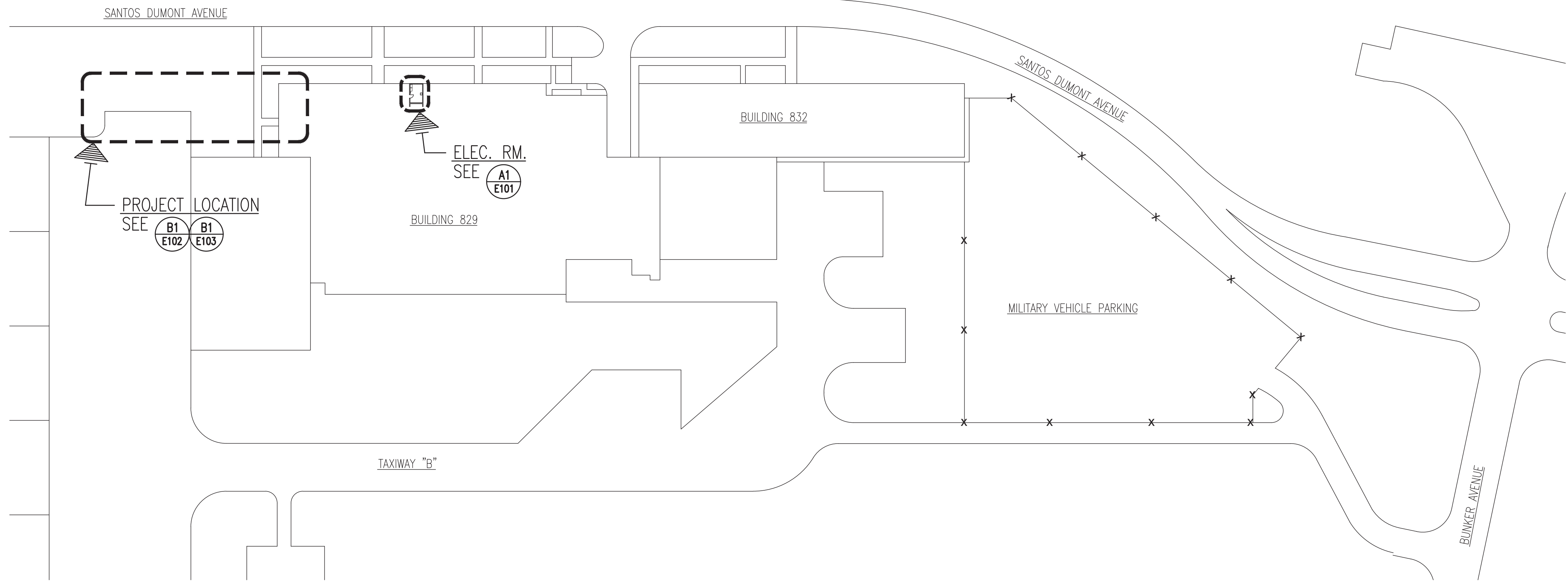

B2 ELECTRICAL SITE PLAN
SCALE: 1" = 60'



BOWERS • KUBOTA CONSULTING

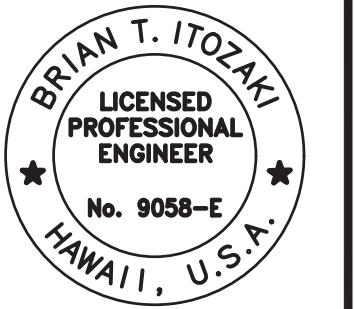

Brian T. Itozaki
Signature
8/4/2024
Expiration Date of the License

THIS WORK WAS PREPARED BY ME OR UNDER MY SUPERVISION

SYMBOL	DESCRIPTION	DATE	APPROVAL

SUBMITTAL DATE: 06/16/23

DES: SM DRW: KN CHK: BI

DEPARTMENT OF DEFENSE
DESIGN AND PROJECT MANAGEMENT BRANCH
WHEELER AASF #1 BLDG. 00823
WHAHAWA, OAHU

STATE OF HAWAII
FACILITY MANAGEMENT OFFICE

HAWAII ARMY NATIONAL GUARD

WHEELER CONSTRUCTION OF
STAND-BY EMERGENCY GENERATOR INSTALLATIONS

ELECTRICAL SITE PLAN

SCALE: AS NOTED

STATE JOB NO. WHEELER CA-202004-C1

FEDERAL PROJECT NO. 15190004

SHEET 11 OF 17

E101

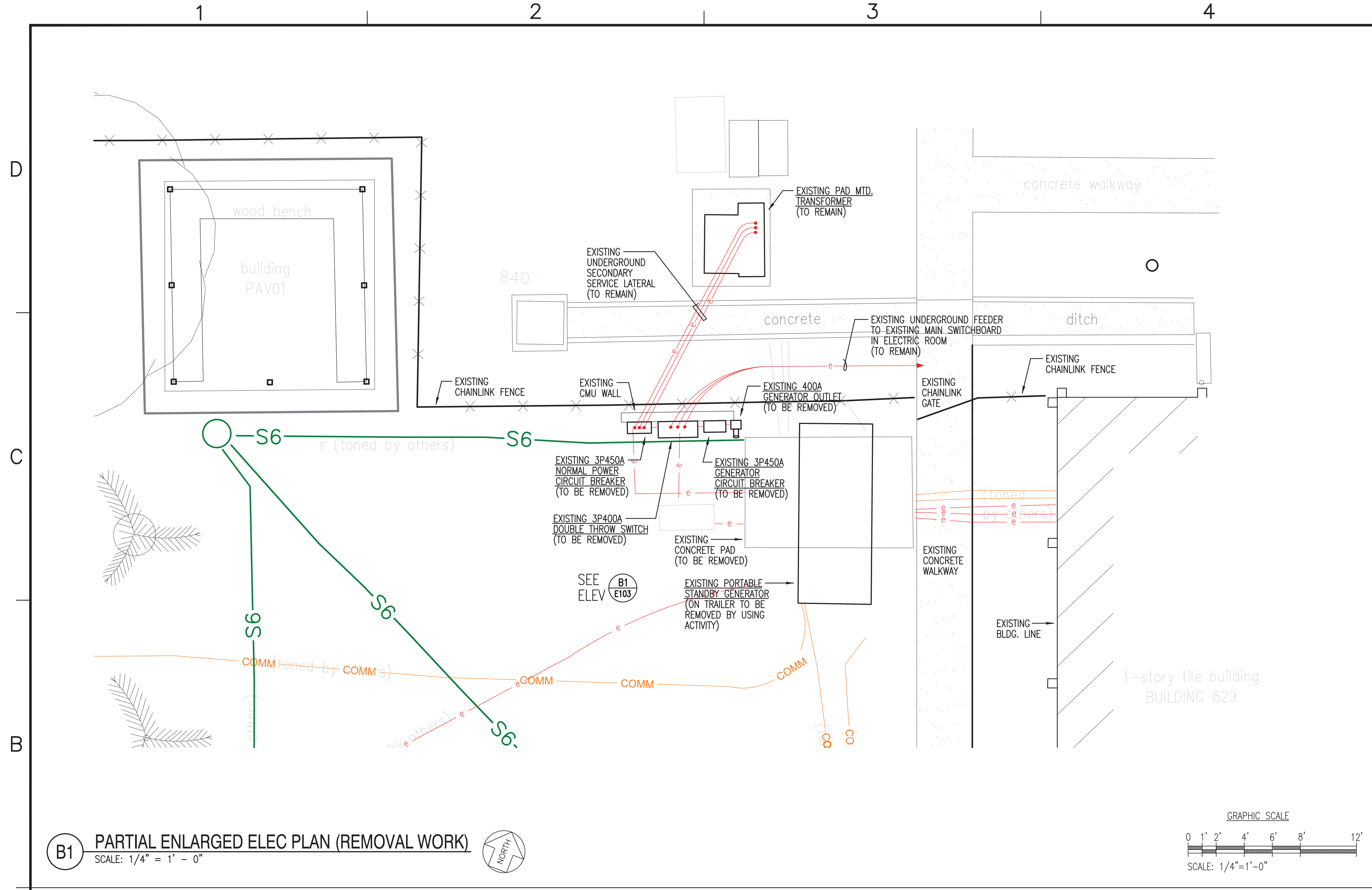

BOWERS + KUBOTA CONSULTING

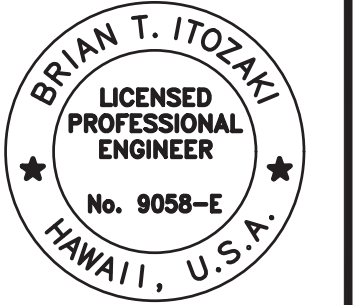

Signature: Brian T. Itozaki
84792024
Expiration Date of the License

THIS WORK WAS PREPARED BY ME OR UNDER MY SUPERVISION

DATE	DESCRIPTION

DES	SM	DRW	KN	CHK	BI
-----	----	-----	----	-----	----

DEPARTMENT OF DEFENSE
DESIGN AND PROJECT MANAGEMENT BRANCH
WAHIAWA, OAHU

HAWAII ARMY NATIONAL GUARD

STATE OF HAWAII
FACILITY MANAGEMENT OFFICE
WHEELER AASF #1 BLDG. 00823

**WHEELER CONSTRUCTION OF
STAND-BY EMERGENCY GENERATOR INSTALLATIONS**

PARTIAL ENLARGED ELEC PLAN (REMOVAL WORK)

SCALE: AS NOTED

STATE JOB NO. WHEELER CA-202004-C1

FEDERAL PROJECT NO. 15190004

SHEET 12 OF 17

E102

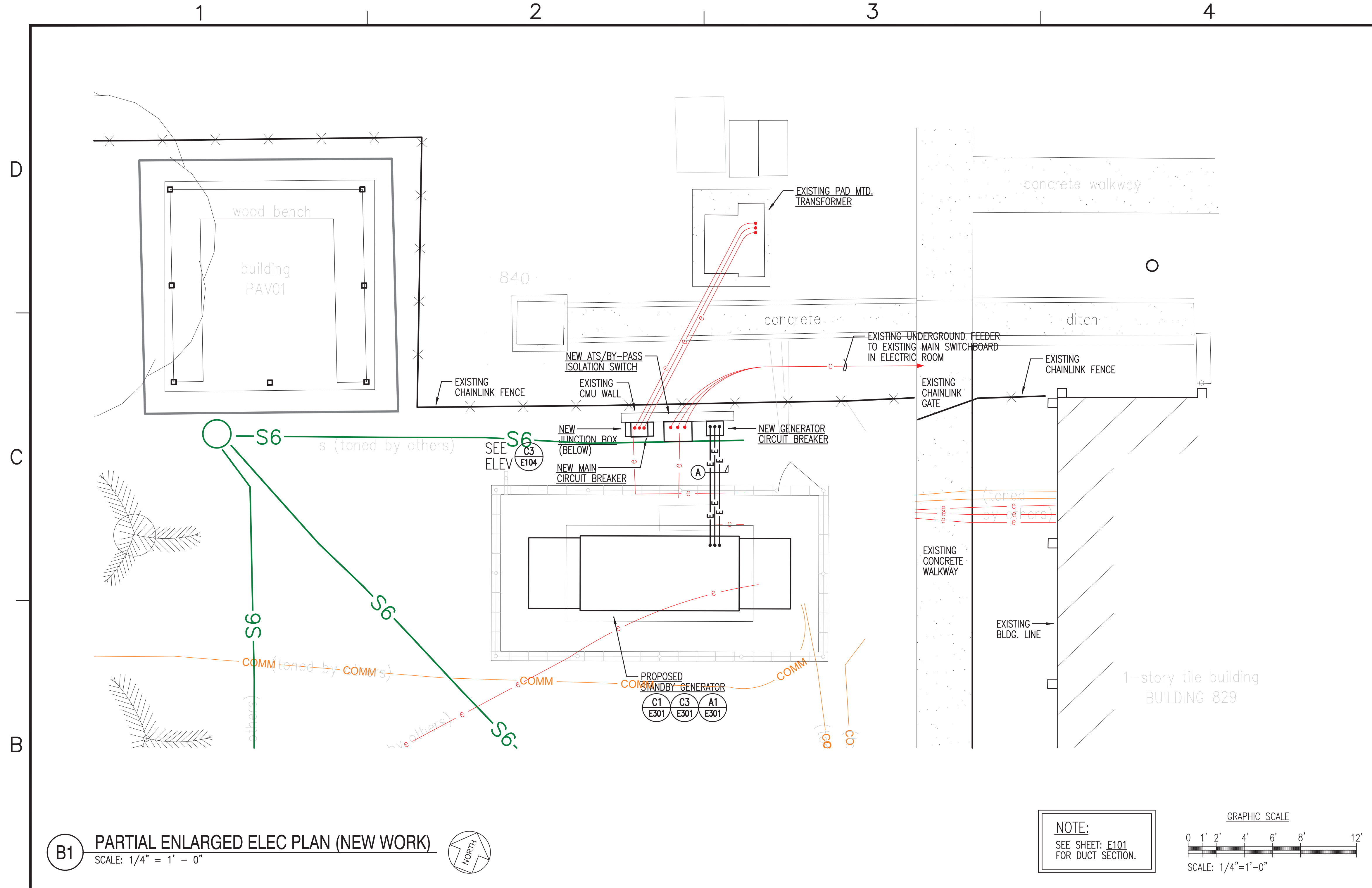

B1 PARTIAL ENLARGED ELEC PLAN (NEW WORK)
SCALE: 1/4" = 1' - 0"



BOWERS • KUBOTA CONSULTING
Project Management • Planning • Architecture/Engineering Design • Construction Management

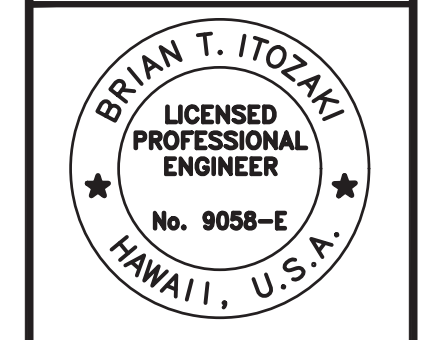

Brian T. Itozaki
Signature
8/4/2024
Expiration Date of the License
THIS WORK WAS PREPARED BY ME OR UNDER MY SUPERVISION

SYN	DESCRIPTION	DATE	APPR

DEPARTMENT OF DEFENSE
DESIGN AND PROJECT MANAGEMENT BRANCH
WHAHAWA, OAHU

STATE OF HAWAII
FACILITY MANAGEMENT OFFICE
WHEELER AASF #1 BLDG. 00823

**WHEELER CONSTRUCTION OF
STANDBY EMERGENCY GENERATOR INSTALLATIONS**

PARTIAL ENLARGED ELEC PLAN (NEW WORK)

SCALE: AS NOTED

STATE JOB NO. WHEELER CA-202004-C1

FEDERAL PROJECT NO. 15190004

SHEET 13 OF 17

E103

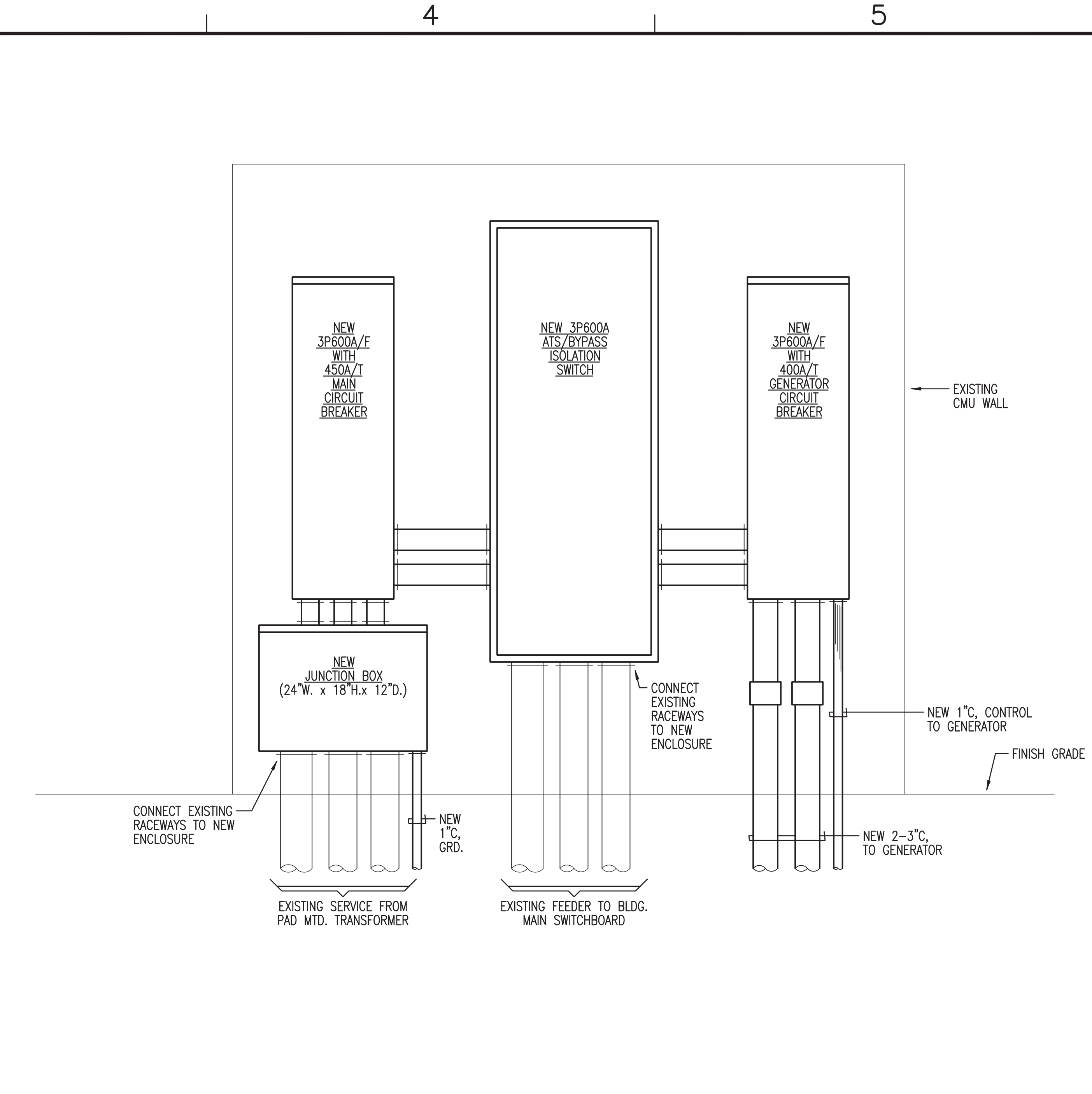
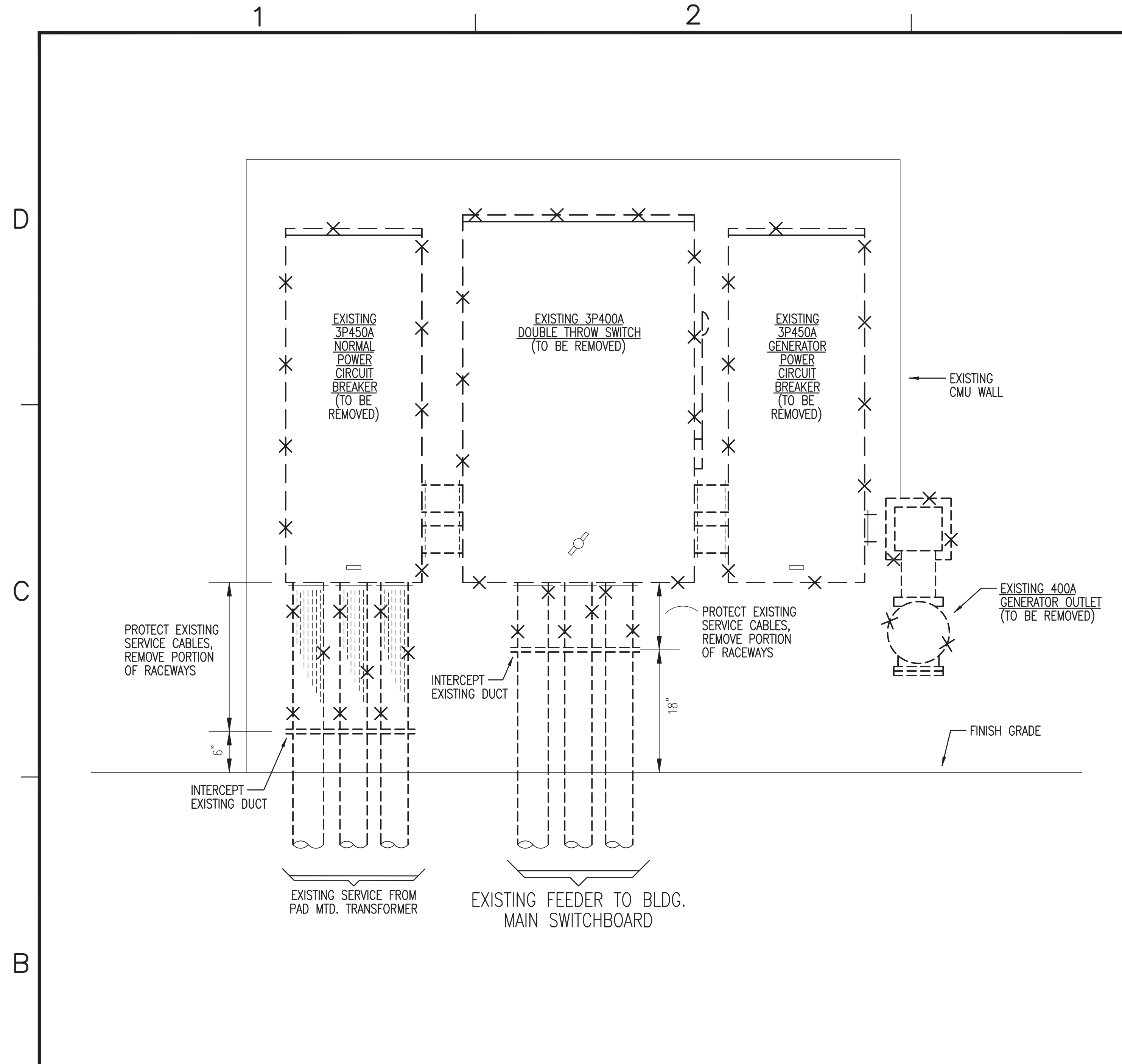

C1 ELEVATION - EXISTING ELECTRICAL SERVICE EQUIPMENT (REMOVAL WORK)
NOT TO SCALE

C3 ELEVATION - NEW ELECTRICAL SERVICE EQUIPMENT
NOT TO SCALE

HAWAII ARMY NATIONAL GUARD

BRIAN T. ITOZAKI
LICENSED PROFESSIONAL ENGINEER
No. 9058-E
HAWAII, U.S.A.

Brian T. Itozaki
Signature

THIS WORK WAS PREPARED BY ME OR UNDER MY SUPERVISION

DATE	DESCRIPTION	BY

SUBMITTAL DATE: 06/16/23

DES	SM	DRW	KN	CHK	BI

DEPARTMENT OF DEFENSE
DESIGN AND PROJECT MANAGEMENT BRANCH
WHAHAWA, OAHU

WHEELER AASF #1 BLDG. 00823

**WHEELER CONSTRUCTION OF
STAND-BY EMERGENCY GENERATOR INSTALLATIONS**

ELEVATIONS - ELECTRICAL SERVICE EQUIPMENT

SCALE: AS NOTED

STATE JOB NO. WHEELER CA-202004-C1

FEDERAL PROJECT NO. 15190004

SHEET 14 OF 17

E104

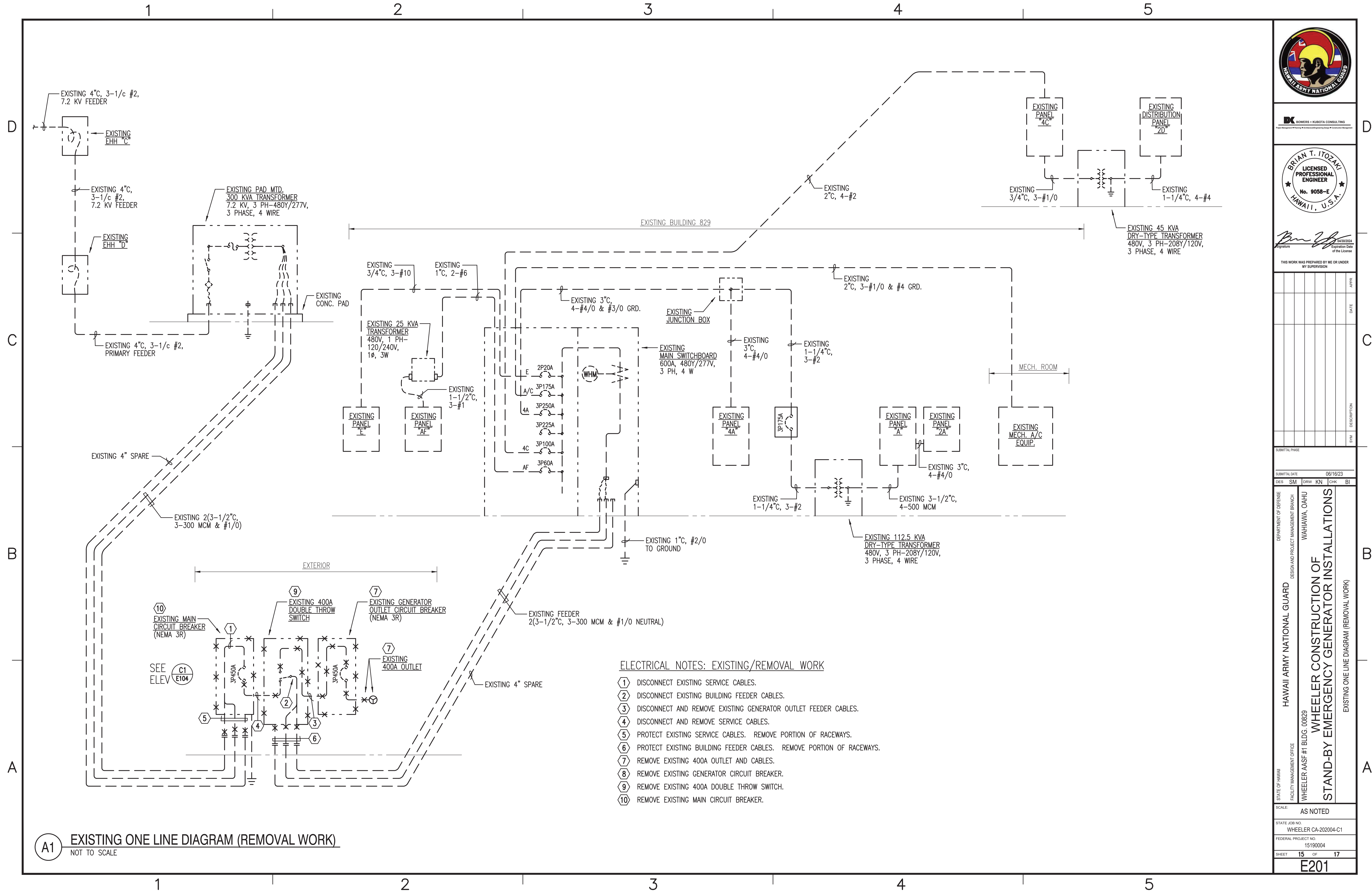

A1 EXISTING ONE LINE DIAGRAM (REMOVAL WORK)
NOT TO SCALE

ELECTRICAL NOTES: EXISTING/REMOVAL WORK

- ① DISCONNECT EXISTING SERVICE CABLES.
- ② DISCONNECT EXISTING BUILDING FEEDER CABLES.
- ③ DISCONNECT AND REMOVE EXISTING GENERATOR OUTLET FEEDER CABLES.
- ④ DISCONNECT AND REMOVE SERVICE CABLES.
- ⑤ PROTECT EXISTING SERVICE CABLES. REMOVE PORTION OF RACEWAYS.
- ⑥ PROTECT EXISTING BUILDING FEEDER CABLES. REMOVE PORTION OF RACEWAYS.
- ⑦ REMOVE EXISTING 400A OUTLET AND CABLES.
- ⑧ REMOVE EXISTING GENERATOR CIRCUIT BREAKER.
- ⑨ REMOVE EXISTING 400A DOUBLE THROW SWITCH.
- ⑩ REMOVE EXISTING MAIN CIRCUIT BREAKER.



BOWERS • KUBOTA CONSULTING
Project Management • Planning • Architecture/Engineering Design • Construction Management

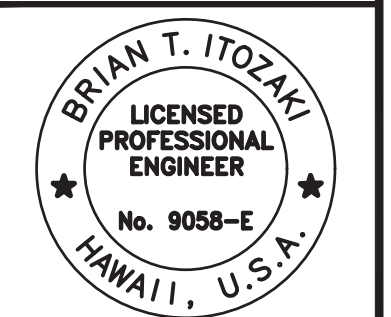

Signature: *Brian T. Itozaki*
8/4/2024
Expiration Date of the License

THIS WORK WAS PREPARED BY ME OR UNDER MY SUPERVISION

SYMBOL	DESCRIPTION	DATE	APPROVED

SUBMITTAL DATE: 06/16/23				
DES	SM	DRW	KN	CHK

DEPARTMENT OF DEFENSE
HAWAII ARMY NATIONAL GUARD
DESIGN AND PROJECT MANAGEMENT BRANCH
WHAHAWA, OAHU
STATE OF HAWAII
FACILITY MANAGEMENT OFFICE
WHEELER AASF #1 BLDG. 00823
**WHEELER CONSTRUCTION OF
STAND-BY EMERGENCY GENERATOR INSTALLATIONS**
EXISTING ONE LINE DIAGRAM (REMOVAL WORK)

SCALE: AS NOTED

STATE JOB NO. WHEELER CA-202004-C1

FEDERAL PROJECT NO. 15190004

SHEET 15 OF 17

E201

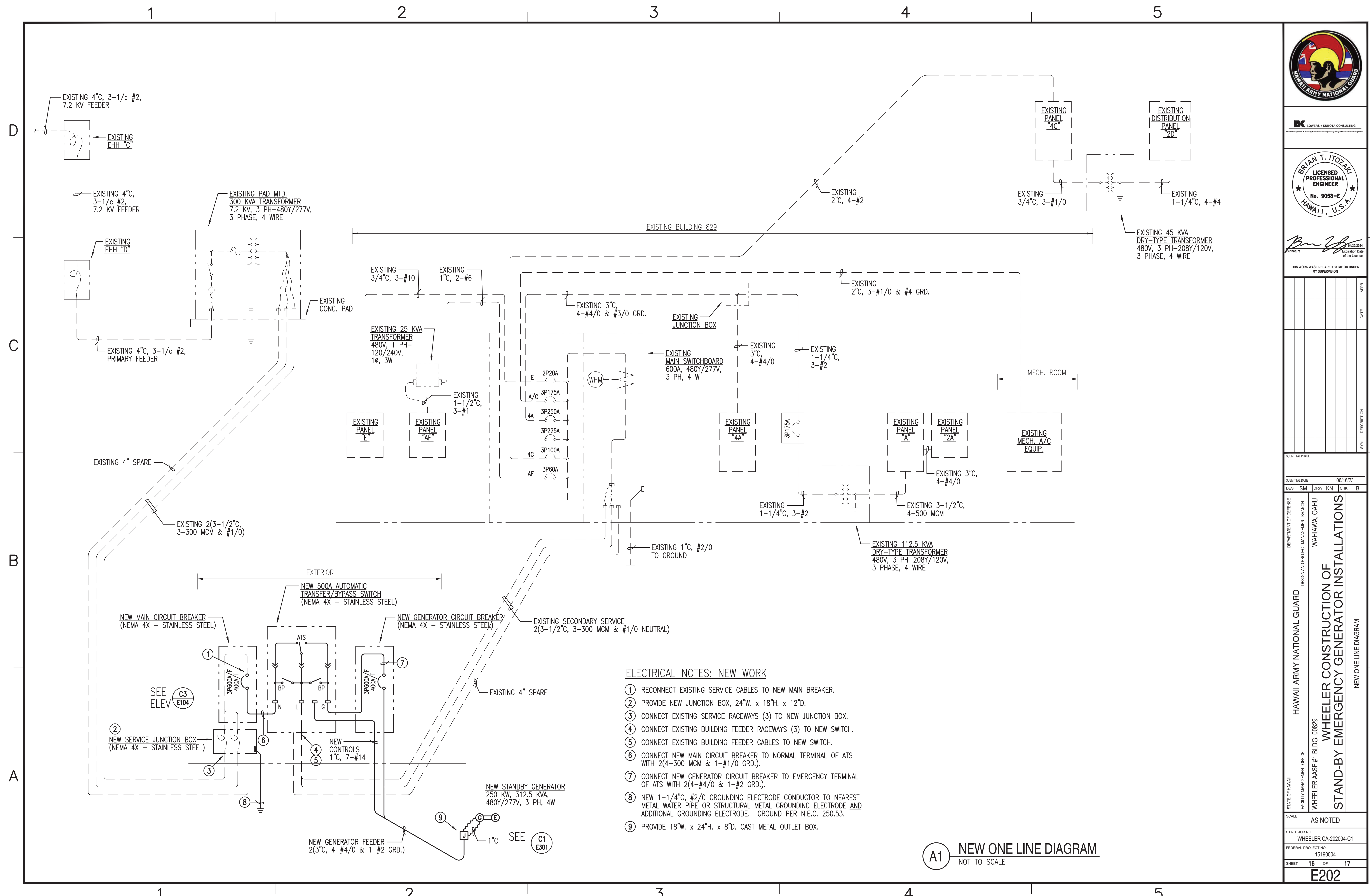

ELECTRICAL NOTES: NEW WORK

- ① RECONNECT EXISTING SERVICE CABLES TO NEW MAIN BREAKER.
- ② PROVIDE NEW JUNCTION BOX, 24"W. x 18"H. x 12"D.
- ③ CONNECT EXISTING SERVICE RACEWAYS (3) TO NEW JUNCTION BOX.
- ④ CONNECT EXISTING BUILDING FEEDER RACEWAYS (3) TO NEW SWITCH.
- ⑤ CONNECT EXISTING BUILDING FEEDER CABLES TO NEW SWITCH.
- ⑥ CONNECT NEW MAIN CIRCUIT BREAKER TO NORMAL TERMINAL OF ATS WITH 2(4-300 MCM & 1-#1/0 GRD.).
- ⑦ CONNECT NEW GENERATOR CIRCUIT BREAKER TO EMERGENCY TERMINAL OF ATS WITH 2(4-#4/0 & 1-#2 GRD.).
- ⑧ NEW 1-1/4", #2/0 GROUNDING ELECTRODE CONDUCTOR TO NEAREST METAL WATER PIPE OR STRUCTURAL METAL GROUNDING ELECTRODE AND ADDITIONAL GROUNDING ELECTRODE. GROUND PER N.E.C. 250.53.
- ⑨ PROVIDE 18"W. x 24"H. x 8"D. CAST METAL OUTLET BOX.

A1 NEW ONE LINE DIAGRAM
NOT TO SCALE



BOWERS • KUBOTA CONSULTING
Project Management • Planning • Architecture/Engineering Design • Construction Management

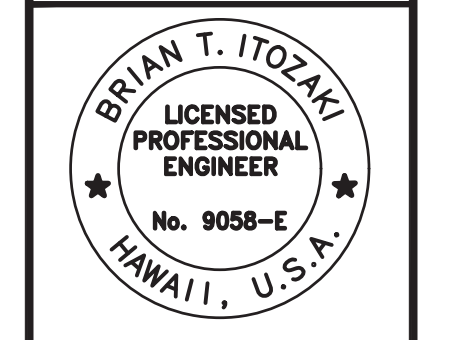

Brian T. Itozaki
Signature
8/4/2024
Expiration Date of the License
THIS WORK WAS PREPARED BY ME OR UNDER MY SUPERVISION

DATE	DESCRIPTION	BY	CHK

DES	SM	DRW	KN	CHK	BI

DEPARTMENT OF DEFENSE
DESIGN AND PROJECT MANAGEMENT BRANCH
HAWAIIA, OAHU
STATE OF HAWAII
FACILITY MANAGEMENT OFFICE
WHEELER AASF #1 BLDG. 00823
HAWAII ARMY NATIONAL GUARD
WHEELER CONSTRUCTION OF
STAND-BY EMERGENCY GENERATOR INSTALLATIONS
NEW ONE LINE DIAGRAM

SCALE: AS NOTED
STATE JOB NO: WHEELER CA-202004-C1
FEDERAL PROJECT NO: 15190004
SHEET 16 OF 17
E202

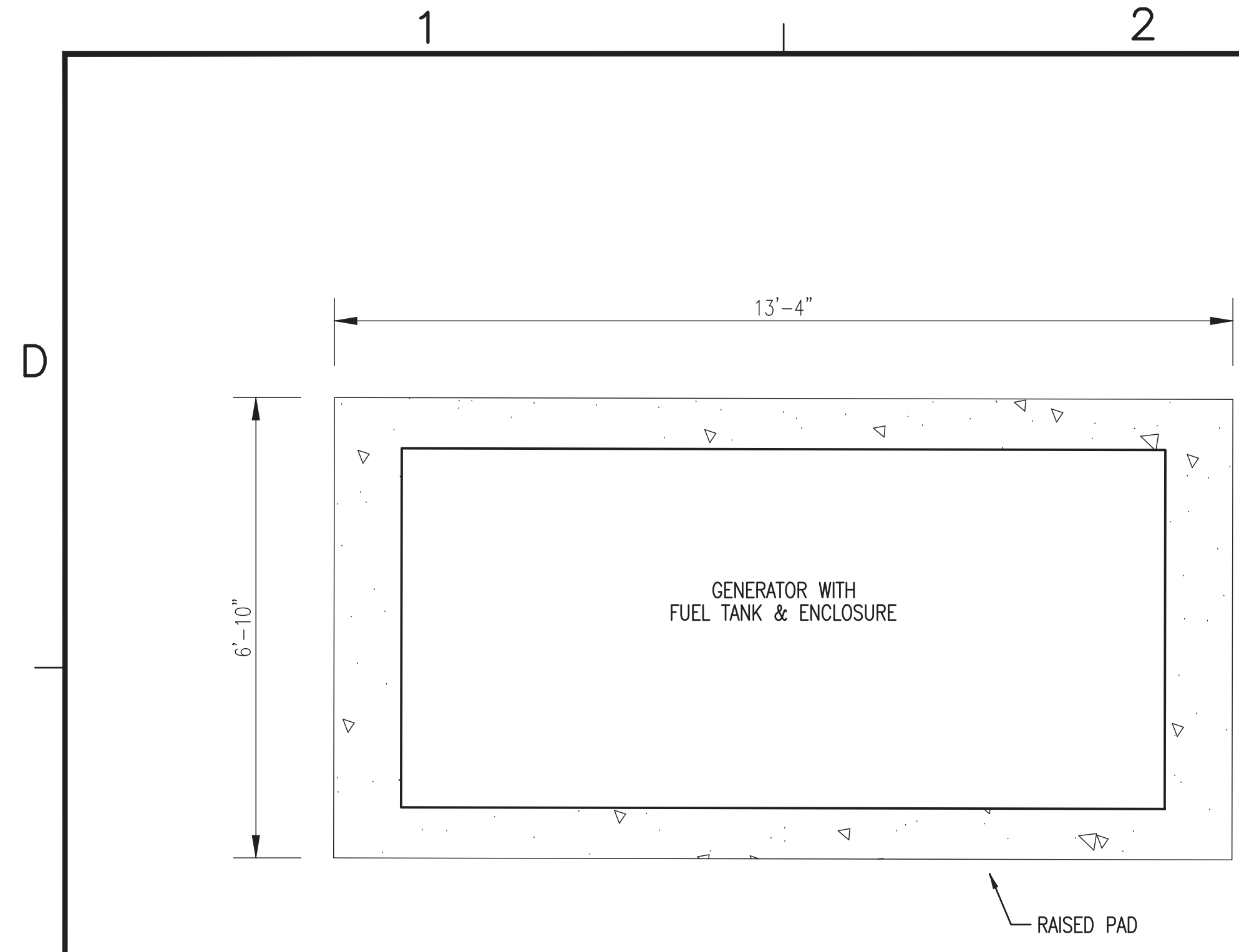

C1 PLAN - GENERATOR & CONCRETE PAD
NOT TO SCALE

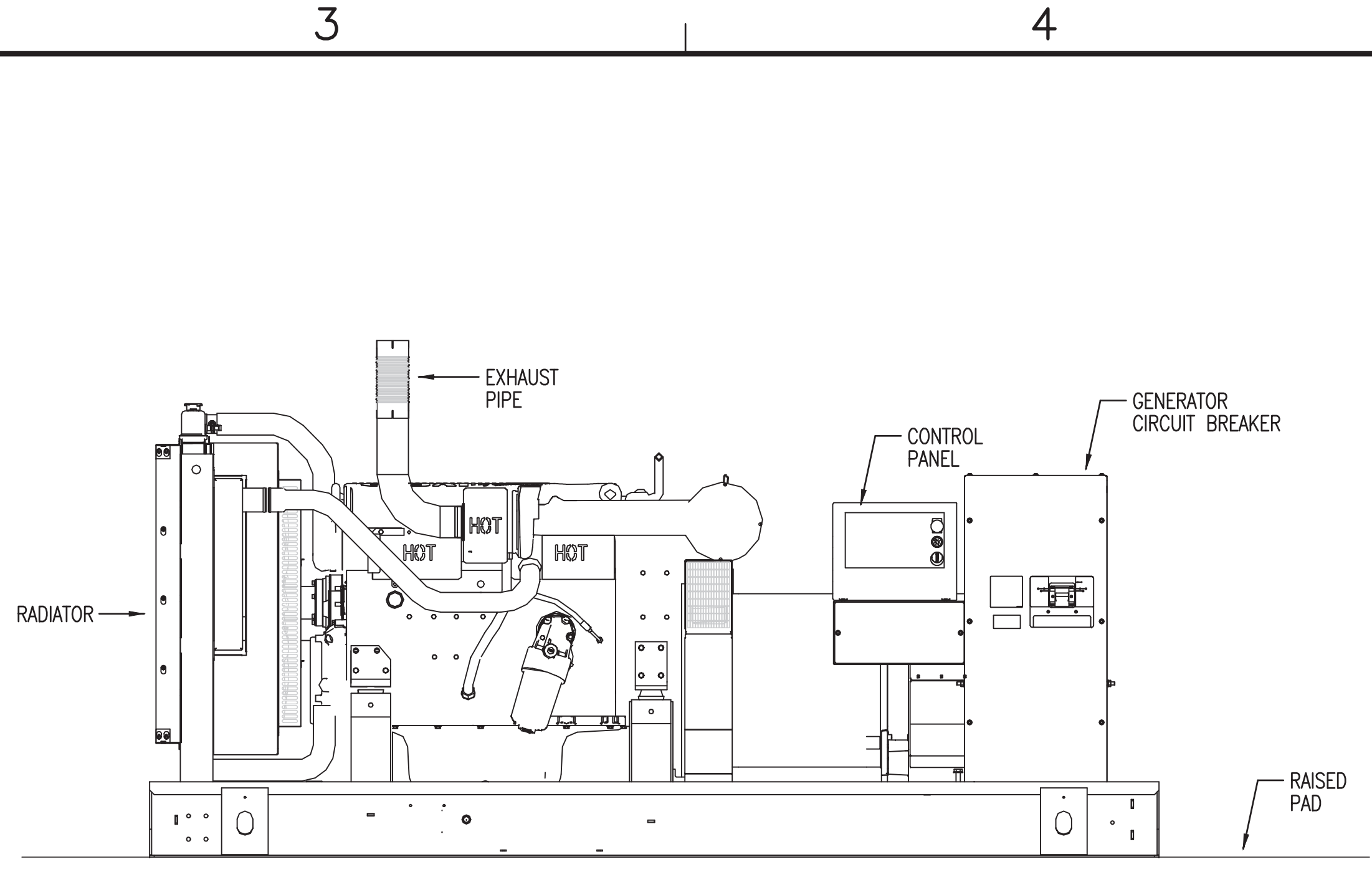

C3 ELEVATION - GENERATOR ONLY (NO BASE TANK & ENCLOSURE SHOWN)
NOT TO SCALE

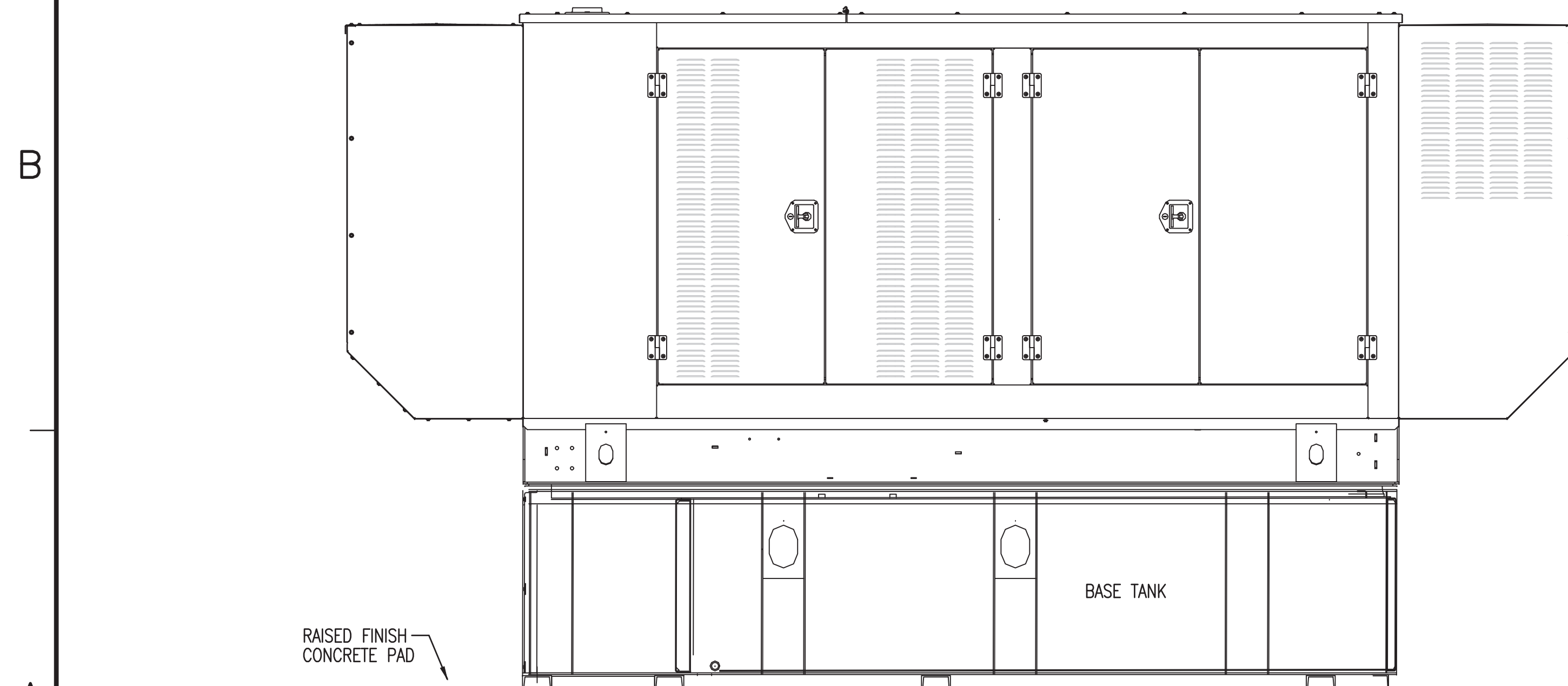

A1 ELEVATION - BASE TANK AND SOUND ATTENUATED ENCLOSURE
NOT TO SCALE

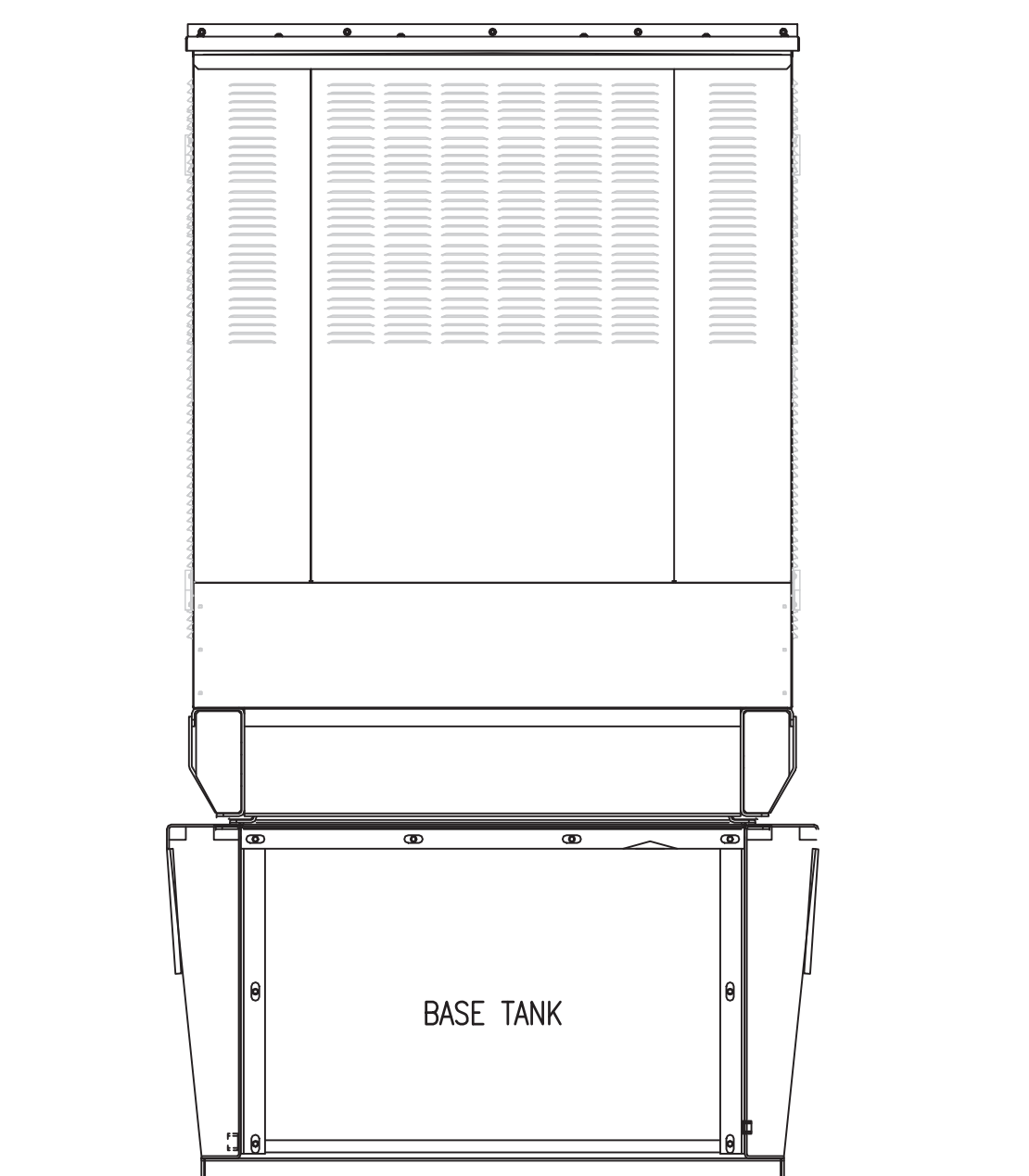

BOWERS • KUBOTA CONSULTING
Project Management • Planning • Architecture/Engineering Design • Construction Management

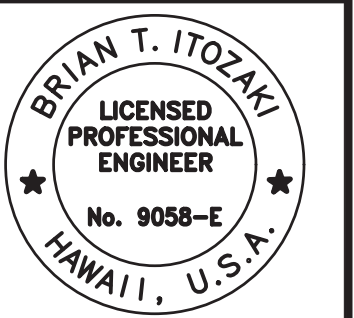

Brian T. Itozaki
Signature
04/29/2024
Expiration Date of the License

THIS WORK WAS PREPARED BY ME OR UNDER MY SUPERVISION

SYN	DESCRIPTION	DATE	APPR

SUBMITTAL PHASE

SUBMITTAL DATE: 06/16/23

DES	SM	DRW	KN	CHK	BI

STATE OF HAWAII
FACILITY MANAGEMENT OFFICE
WHEELER AASF #1 BLDG. 00823

DEPARTMENT OF DEFENSE
DESIGN AND PROJECT MANAGEMENT BRANCH
WAIHAWA, OAHU

HAWAII ARMY NATIONAL GUARD
WHEELER CONSTRUCTION OF
STAND-BY EMERGENCY GENERATOR INSTALLATIONS
GENERATOR DETAILS

SCALE: AS NOTED

STATE JOB NO. WHEELER CA-202004-C1

FEDERAL PROJECT NO. 15190004

SHEET 17 OF 17

E301

ATTACHMENT M
HIARNG ENVIRONMENTAL CONTRACTOR REQUIREMENTS

PROJECT NAME:	
PROJECT NUMBER:	SUBMISSION DATE:
REVIEWER: ENV-Compliance	DATE REVIEWED:
	DATE RECEIVED:

	COMMENTS
X	In order to facilitate Emergency Planning and Community Right-to-Know Act (EPCRA) reporting requirements, prior to project start and within 30 days of completion of the project, contractor shall submit to HIARNG-ENV a Hazardous Material Inventory Log of chemical products to be used in the project, and provide an update no later than 31 January of each calendar year. The log shall include the product name and manufacturer ID number, container size, amount used, and maximum number of containers to be stored on site at any given day during the project. HIARNG-ENV may waive this requirement based upon contractor request. (Sample inventory log attached). Safety Data Sheets (SDSs) shall be provided or made available to the government COR/project manager and HIARNG-ENV upon request.
X	Prior to project start, Contractor will provide to HIARNG-ENV and the COR/project manager an estimate of the maximum amount of hazardous waste, universal waste, and other regulated waste (e.g., asbestos, lead paint chips, fluorescent lamps, PCB ballasts) expected to be generated per month, and the total amount anticipated to be stored on-site at any given time. Contractor shall also provide name of disposal/recycling facilities and transporters to be used for hazardous waste, including their EPA ID numbers; disposal/recycling facilities and transporters used must be listed on DRMS's lists of Qualified Facilities and Qualified Transporters at http://www.dispositionservices.dla.mil/newenv/hwdisposal.shtml . All waste will be stored in a secured area pending removal for disposal, with signage indicating contact information, and shall be managed, packaged, and transported in accordance with all applicable federal, state, and local regulations. Monthly waste generation reports shall be provided to HIARNG-ENV and the COR/project manager by the 5 th of the month after the end of the month being reported. The reports shall indicate the type of waste and the number of pounds of each type generated in each container each month. (Sample container waste collection log and waste generation report attached).
X	Contractor shall be responsible for all costs for disposal of waste generated from this project and shall provide copies of all waste disposal documentation (including any required lab analyses, waste profiles, and any other supporting documentation) to the HIARNG-ENV and the COR/project manager, along with draft copies of the waste manifests for review prior to waste shipment off-site for disposal. The applicable HIARNG EPA ID Number shall be used on waste manifests, and manifests will only be signed by individuals authorized by HIARNG-ENV.
X	All construction sites are subject to the regulations of 40 CFR 112 <i>Oil Pollution Prevention</i> and are required to prepare a site specific Spill Prevention, Control and Countermeasure (SPCC) plan if storing more than 1320 gallons (G) of POL on site. A copy of the SPCC plan must be submitted to HIARNG-ENV before start of the project and kept readily available on site. If the site is storing less than 1320 G of POL no SPCC plan is required, however, the contractor shall implement the applicable HIARNG SPCC plan.
X	Contractor, in general, shall be responsible for assessing whether the project and/or project activities require environmental permits and are responsible for obtaining, implementing and maintaining all applicable permit requirements.
X	All projects that disturb more than 1 acre of soil, including projects that, considered with other related projects (i.e., are part of a larger common plan of development or sale), cumulatively

	disturb more than 1 acre of soil, are required to obtain an applicable National Pollutant Discharge Elimination System (NPDES) stormwater discharge permit from the Hawaii Department of Health (HDOH) and implement all permit requirements, plans, and inspections. Sites less than 1 acre are required to implement best management practices (BMP's) to prevent contaminated stormwater from leaving the site.
X	Contractors shall be responsible for assessing the need for and obtaining the following permits as applicable: NPDES permits for construction activity, underground injection control well (UIC), oil water separator, grease trap, and individual waste water system. The ENV office shall be copied on all permit correspondence, and shall be provided the original copy of all permits.
X	Contractors are required to install and maintain stormwater Best Management Practices (BMPs) and protective measures (regardless of project size or scope) to prevent the pollution of stormwater to the maximum extent practicable (MEP).
X	Contractor shall be responsible for complying with all existing and applicable HIARNG environmental permits, e.g., National Pollutant Discharge Elimination System (NPDES) permits, UIC permits, Industrial Wastewater Discharge permits (IWDPs), Individual Wastewater System (IWS) permits, etc.
X	Contractor shall post emergency contact sign indicating the name and phone number for the government COR/project manager, the contractor emergency contact, police/fire department 911, and HIARNG ENV 672-1013. (Sample sign attached). Contractor shall report spills immediately to the COR and HIARNG-ENV and complete the HIARNG Spill Incident Report Form as required. Contractor shall immediately clean up all spills IAW federal and state guidelines and to the satisfaction of HIARNG-ENV. Contractor shall maintain adequate spill supplies commensurate with the potential for spills, and will contract out spill cleanup beyond their capabilities. Contractor shall accomplish all regulatory verbal and written notifications to the State Emergency Response Commission, Local Emergency Planning Committee (LEPC), National Response Center (NRC), Environmental Protection Agency (EPA), as applicable, and provide HIARNG-ENV copies of all spill reports submitted.
X	Send to HIARNG-ENV the data for non-hazardous recycled/diverted waste (i.e. waste that does not go into the landfill or H-POWER) and non-hazardous disposed waste for all construction projects. Data can be provided by any means (e.g. receipt copies, Excel table, email message) Data should include: <ul style="list-style-type: none"> Recycled/Diverted waste <ul style="list-style-type: none"> -type of material -net weight -recycle facility (e.g. Schnitzer, Island Recycling, Refrigerant Recycling) -ticket number (if available) -cost/revenue (if applicable) Disposed waste <ul style="list-style-type: none"> -net weight -disposal facility (e.g. PVT, Schnitzer) -ticket number (if available) -cost (if applicable)

HIARNG Spill Incident Report Form

REPORT SPILLS IMMEDIATELY TO HIARNG-ENV AT 672-1013.
 Fax this form to 672-1262 or e-mail ng.hi.hiarng.list.nghi-env-comp@mail.mil within 72 hours of the spill.

1	LOCATION OF SPILL (Facility/Address/Bldg):	DATE & TIME OF SPILL:	
2	CALLER NAME & PHONE NUMBER:	OSC NAME & PHONE NUMBER:	
3	ORGANIZATION REPORTING:		
4	DATE AND TIME OF DISCOVERY:	DURATION OF THE SPILL:	
5	TIME & DATE HIARNG ENV NOTIFIED (672-1013):	PERSON NOTIFIED:	
6	SUBSTANCE SPILLED (<i>Attach SDS</i>):	AMOUNT SPILLED:	SIZE OF AREA IMPACTED:
7	CAUSE AND SOURCE OF THE SPILL:		
8	EXTENT AND SEVERITY OF SPILL: Potential Dangers: <input type="checkbox"/> Fire <input type="checkbox"/> Explosion <input type="checkbox"/> Toxic Fumes/Fluid <input type="checkbox"/> Evacuation Needed <input type="checkbox"/> Damage or Injuries (<i>Specify</i>): Media into Which the Release Occurred or is Likely to Occur (Check all applicable): <input type="checkbox"/> Soil <input type="checkbox"/> Concrete <input type="checkbox"/> Asphalt <input type="checkbox"/> UIC <input type="checkbox"/> Storm Drain <input type="checkbox"/> Swale <input type="checkbox"/> Sewer <input type="checkbox"/> Stream <input type="checkbox"/> Other (<i>Specify</i>): Raining? <input type="checkbox"/> No <input type="checkbox"/> Yes Raining Imminent? <input type="checkbox"/> No <input type="checkbox"/> Yes Direction of Flow:		
9	RESPONSE ACTIONS TAKEN TO STOP, REMOVE, AND MITIGATE EFFECTS OF THE SPILL:		
10	ADDITIONAL ASSISTANCE REQUIRED? <input type="checkbox"/> No <input type="checkbox"/> Yes (<i>Specify</i>):		
11	OTHER HIARNG OR EXTERNAL AGENCIES NOTIFIED (<i>Agency, Individual, Date, Time, and Incident Number Assigned by Agency</i>): <input type="checkbox"/> Fire Dept. <input type="checkbox"/> Ambulance <input type="checkbox"/> Other (<i>Specify</i>):		
12	PREVENTIVE ACTIONS TO BE TAKEN: (<i>NOTE: This incident is required to be covered in the next unit/activity spill training.</i>)		
13	SUBMITTED BY (<i>Name, Title, Phone</i>)		

For Environmental Office Use Only.

1	REPORTABLE? <input type="checkbox"/> No <input type="checkbox"/> Yes	REPORTABLE QTY:	Samples Taken? <input type="checkbox"/> No <input type="checkbox"/> Yes
2	VERBAL NOTIFICATIONS MADE (<i>Indicate Agency, Individual, Date, and Time Notified, and any Incident Number Assigned</i>) <input type="checkbox"/> SERC (HEER): <input type="checkbox"/> LEPC: <input type="checkbox"/> NRC (800) 424-8801: <input type="checkbox"/> Other (<i>Specify</i>): DATE WRITTEN NOTIFICATIONS MADE:		
3	CORRECTIVE ACTIONS TAKEN/ RECOMMENDED TO PRECLUDE RECURRENCE:		

